



LOVE
CERAMIC TILES

[Index](#) ▼

[Colour Map](#) ▼

[Collections](#) ▼

[Technical Specifications](#) ▼

2023



LOVE
CERAMIC TILES

15

YEARS
of LOVE

15 ANOS, UM SÓ CORAÇÃO.

Os aniversários servem para nos lembrar que tudo na vida tem um começo e que o ponto de partida deve ser sempre celebrado com aqueles que fazem parte do nosso caminho. Esta celebração é feita de pessoas extraordinárias, de mentes brilhantes, de visionários que não se acomodam e de equipas persistentes que não desistem. Exceder-nos, sermos mais e melhor, está no nosso ADN.

Celebrar 15 anos é uma data que nos mantém motivados por todo o caminho que já percorremos juntos, mas também uma data que nos enche de esperança e amor pelos anos que estão por vir, sempre próximos dos nossos clientes, parceiros e colegas.

15 anos de um só coração. 15 anos a celebrar o design e a criatividade.

15 ANS, UN SEUL CŒUR.

Les anniversaires servent à nous rappeler que tout dans la vie a un début et que le point de départ doit toujours être célébré avec ceux qui font partie de notre chemin. Cette célébration concerne des personnes extraordinaires, des esprits brillants, des visionnaires qui ne se contentent pas de rien et des équipes tenaces qui ne baissent pas les bras. Se dépasser, être plus et mieux, c'est dans notre ADN.

Célébrer 15 ans est une date qui nous motive sur le chemin que nous avons déjà parcouru ensemble, mais aussi une date qui nous remplit d'espoir et d'amour pour les années à venir, toujours proches de nos clients, nos partenaires et nos collègues.

15 ans d'un seul cœur. 15 ans de célébration du design et de la créativité.

15 ЛЕТ, ЕДИНОЕ СЕРДЦЕ.

Дни рождения напоминают нам о том, что всё в жизни имеет начало, и что момент, с которого мы начали, всегда надо отмечать вместе с теми, кто стал частью нашего пути. Этот праздник состоит из необыкновенных людей, блестящих умов, провидцев, которые не останавливаются на достигнутом, и настойчивых команд, которые не сдаются. Превзойти самих себя, стать больше и лучше — это заложено в нашей ДНК.

Празднование 15-летия — это дата, мотивирующая нас на пути, который мы прошли вместе, дата, наполняющая нас надеждой и любовью на грядущие годы, всегда рядом с нашими клиентами, партнерами и коллегами.

15 лет единого сердца. 15 лет праздника дизайна и творчества.

15 YEARS, ONE HEART.

Anniversaries remind us that everything in life has a beginning and that the starting point should always be celebrated with those who are part of our path. This celebration is made of extraordinary people, brilliant minds, visionaries who do not settle and persistent teams who do not give up. Exceeding ourselves, being more and better, is in our DNA.

Celebrating 15 years is a date that keeps us motivated by all the path we have already travelled together, but also a date that fills us with hope and love for the years to come, always close to our clients, partners and colleagues.

15 years of a single heart. 15 years celebrating design and creativity.

15 JAHRE, EIN EINZIGES HERZ.

Jahrestage dienen dazu, uns daran zu erinnern, dass alles im Leben einen Anfang hat und dass der Beginn immer mit denjenigen gefeiert werden sollte, die Teil unseres Weges sind. Diese Feier besteht aus außergewöhnlichen Menschen, brillanten Köpfen, Visionären, die sich nicht zufrieden geben, und hartnäckigen Teams, die nicht aufgeben. Über uns hinauszuwachsen, mehr und besser zu sein, liegt in unserer DNA.

15 Jahre zu feiern ist ein Datum, das uns motiviert durch den Weg, den wir bereits gemeinsam zurückgelegt haben, aber auch ein Datum, das uns mit Hoffnung und Liebe für die kommenden Jahre erfüllt, immer in der Nähe unserer Kunden, Partner und Kollegen.

15 Jahre lang ein einziges Herz. 15 Jahre, in denen Design und Kreativität gefeiert werden.

15 ANNI, UN SOLO CUORE.

Gli anniversari servono a ricordarci che tutto nella vita ha un inizio e che il punto di partenza va sempre festeggiato con coloro che fanno parte del nostro percorso. Questa celebrazione è fatta di persone straordinarie, menti brillanti, visionari che non si accontentano e team tenaci che non si arrendono. Superare noi stessi, essere di più e migliori, è nel nostro DNA.

Festeggiare 15 anni è una data che ci tiene motivati lungo tutto il percorso che abbiamo già intrapreso insieme, ma anche una data che ci riempie di speranza e amore per gli anni a venire, sempre vicini ai nostri clienti, partner e colleghi.

15 anni di un solo cuore. 15 anni di celebrazione del design e della creatività.

LOVE
CERAMIC TILES

Index ▾

Colour Map ▾

Collections ▾

Technical Specifications ▾



Índice

Index

ARISE	P. 297	
AVENUE	P. 365	
BALANCE	P. 311	
CANYON	P. 371	
CORE	P. 135	
GENESIS	P. 157	
GRAVITY	P. 227	
GROUND	P. 263	
LIGHT	P. 221	
MARBLE	P. 97	
MÉMORABLE	P. 281	
METALLIC	P. 59	
NATIVE	P. 323	
NEST	P. 123	
PRECIOSUS	P. 79	
PULSE	P. 251	
SENSE	P. 25	
SPLASH	P. 201	
TIMBER	P. 355	
URBAN	P. 147	
WOODEN	P. 339	
CALIBERS	P. 400	
CERTIFICATION	P. 376	
COLOUR MAP	P. 10	
GENERAL SALES CONDITIONS	P. 404	
LAYING SUGGESTIONS	P. 403	
LOVE GREEN	P. 376	
OUTDOOR EXTRA THICK	P. 382	
PACKAGE	P. 398	
PR()TECT	P. 374	
SYMBOLS	P. 401	
TECHNICAL INFORMATION	P. 386	

Index ▼

Anti-slip's
Outdoor extra thick
Sizes
Thickness

Colour Map ▼

Collections ▼

Technical Specifications ▼

Índice de Formatos

Sizes' Index | Index Formats | Index Formate | Указатель формата | Indice per Formato

		RETIFICADO Rectified Rectifié Rektifiziert Ректифицированный Rettificato				NÃO RETIFICADO Non-Rectified Non Rectifié Nicht Rektifiziert Не Ректифицированный Non Rettificato		
		45x120	45x119	35x100	35x70	30x60	31x62	20x60
								
CORE	P. 135			•		•		
GENESIS	P. 157	•		•		•		
GRAVITY	P. 227			•				•
GROUND	P. 263							•
LIGHT	P. 221	•		•	•	•	•	
MARBLE	P. 97		•	•	•			
METALLIC	P. 59	•		•				
NEST	P. 123			•		•	•	
PRECIOUS	P. 79		•	•	•			
PULSE	P. 251							•
SENSE	P. 25			•	•			
SPLASH	P.201			•				•
URBAN	P. 147			•		•		

		RETIFICADO Rectified Rectifié Rektifiziert Ректифицированный Rettificato					NÃO RETIFICADO Non-Rectified Non Rectifié Nicht Rektifiziert Не Ректифицированный Non Rettificato				
		40x120	80x80	79x79	60x90	60x60	30x60	20x100	61x61	60x60	31x61
											
ARISE	P. 297		•			•	•		•		
AVENUE	P. 365				•	•				•	
BALANCE	P. 311		•			•	•		•		•
CANYON	P. 371				•	•				•	
GRAVITY	P. 227		•			•					
GROUND	P. 263				•	•			•	•	
LIGHT	P. 221					•					
MARBLE	P. 97		•	•		•					
MÉMORABLE	P. 281				•	•	•				
METALLIC	P. 59					•					
NATIVE	P. 323	•						•			
NEST	P. 123					•			•		•
PRECIOUS	P. 79		•	•		•					
PULSE	P. 251					•			•		
SENSE	P. 25		•			•	•				
SPLASH	P. 201					•			•		
TIMBER	P. 355							•			
WOODEN	P. 339	•						•			

Index ▾

Anti-slip's

Outdoor extra thick

Sizes

Thickness

Colour Map ▾

Collections ▾

Technical Specifications ▾

Índice Espessuras

Thickness' Index | Index Épaisseurs | Index Fertigungen | Указатель толщины | Indice per Spessore

		7 mm	8 mm	9 mm	9,5 mm	20 mm
ARISE	P. 297		•	•		
AVENUE	P. 365					•
BALANCE	P. 311		•	•		
CANYON	P. 371					•
CORE	P. 135	•	•			
GENESIS	P. 157	•	•		•	
GRAVITY	P. 227		•	•		
GROUND	P. 263		•			•
LIGHT	P. 221	•	•	•	•	
MARBLE	P. 97		•	•	•	
MÉMORABLE	P. 281		•			•
METALLIC	P. 59		•		•	
NATIVE	P. 323		•			•
NEST	P. 123	•	•			
PRECIOUS	P. 79		•	•	•	
PULSE	P. 251		•			
SENSE	P. 25		•	•		
SPLASH	P. 201		•			
TIMBER	P. 355		•			
URBAN	P. 147	•	•			
WOODEN	P. 339		•			•

Índice Antiderrapante

Anti-Slip's Index | Index Glissement | Index Rutschen | Индекс противоскольжения | Indice Anti slip

		DIN EN 16165 Anexo B			DIN EN 16165 Anexo A			DIN EN 16165 Anexo C	AS/NZS 4586			ENV 12633 Classe	
		R12	R11	R10	C	B	A	≥36	P5	P4	P3	3	2
ARISE	P. 297		•		•			•					
BALANCE	P. 311		•	•	•	•		•		•		•	•
MÉMORABLE	P. 281		•	•	•	•		•		•		•	•
NATIVE	P. 323		•	•	•		•	•		•			•
SENSE	P. 25			•		•		•		•			•
TIMBER	P. 355		•		•			•		•		•	
WOODEN	P. 339		•		•			•		•			

Índice Outdoor Extra Thick

Outdoor Extra Thick's Index | Index Outdoor Extra Thick | Index Outdoor Extra Thick
Индекс Outdoor экстра утолщенный | Indice Outdoor Extra Thick

		DIN EN 16165 Anexo B			DIN EN 16165 Anexo A			DIN EN 16165 Anexo C	AS/NZS 4586			ENV 12633 Classe	
		R12	R11	R10	C	B	A	≥36	P5	P4	P3	3	2
AVENUE	P. 365		•		•			•		•			
CANYON	P. 371	•			•			•		•		•	
GROUND	P. 263		•		•			•		•		•	
MÉMORABLE	P. 281		•		•			•		•			
NATIVE	P. 323		•		•			•		•			
WOODEN	P. 339		•		•			•		•			

Index ▾

Anti-slip's

Outdoor extra thick

Sizes

Thickness

Colour Map ▾

Collections ▾

Technical Specifications ▾

Colour Map

Concrete Look



CORE LIGHT GREY
P. 140



GRAVITY WHITE
P. 240



CORE BEIGE
P. 140



GRAVITY BEIGE
P. 240



GROUND CREAM
P. 272



ARISE WHITE
P. 306



MÉMORABLE BLANC
P. 290



BALANCE BEIGE
P. 318



CORE WHITE
P. 140



GROUND WHITE
P. 272



BALANCE WHITE
P. 318



GRAVITY LIGHT GREY
P. 240



PULSE WHITE
P. 260



BALANCE LIGHT GREY
P. 319



CORE GREY
P. 140



PULSE GREIGE
P. 260

Colour Map

Concrete Look

1/2 ▶

Index ▼

Colour Map ▼

Chromatic look

Concrete look

Marble look

Stone look

Wood look

Collections ▼

Technical Specifications ▼

Colour Map

Concrete Look

◀ 1 / 2



ARISE BEIGE
P. 306



GROUND LIGHT GREY
P. 273



GROUND TORTORA
P. 272



MÉMORABLE TAUPE
P. 290



GRAVITY RESIN ORANGE
P. 240



GRAVITY OXID GREEN
P. 240



PULSE GREY
P. 260



ARISE GREY
P. 307



BALANCE GREY
P. 319



GROUND GREY
P. 273



MÉMORABLE GRIS
P. 291



GRAVITY GREY
P. 241

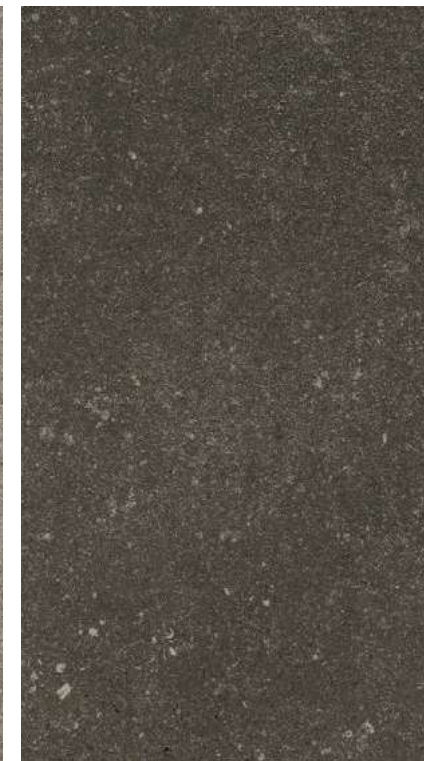

ARISE ANTHRACITE
P. 307

Colour Map

Concrete Look

Index ▼

Colour Map ▼

Chromatic look

Concrete look

Marble look

Stone look

Wood look

Collections ▼

Technical Specifications ▼

Colour Map

Wood Look



TIMBER WHITE
P. 362



NATIVE WHITE
P. 332



WOODEN LIGHT BEIGE
P. 348



TIMBER LIGHT BEIGE
P. 362



NATIVE LIGHT BEIGE
P. 332



TIMBER TORTORA
P. 362



WOODEN TORTORA
P. 348



NATIVE GREY
P. 332



WOODEN BEIGE
P. 348



TIMBER BEIGE
P. 362



NATIVE DARK BEIGE
P. 332



WOODEN DARK BEIGE
P. 348



NATIVE TORTORA
P. 332



WOODEN BROWN
P. 348



TIMBER BROWN
P. 362



NATIVE GINGER
P. 332

Colour Map

Wood Look

Index ▾

Colour Map ▾

chromatic look

Concrete look

Marble look

Stone look

Wood look

Collections ▾

Technical Specifications ▾

Stone Look



SENSE WHITE
P. 48



SENSE BEIGE
P. 48



URBAN SLATE BEIGE
P. 152



URBAN STRIPES BEIGE
P. 153



URBAN ROUGH BEIGE
P. 152



URBAN ROUGH GREY
P. 152



ARISE WHITE
P. 306



NEST BEIGE
P. 128



NEST WHITE
P. 128



URBAN SLATE WHITE
P. 152



URBAN STRIPES WHITE
P. 153



URBAN ROUGH WHITE
P. 152



URBAN SLATE GREY
P. 152



URBAN STRIPES GREY
P. 153



NEST GREY
P. 128



SENSE LIGHT GREY
P. 48

Stone Look

1/2 ▶

Colour Map ▼

Chromatic look

Concrete look

Marble look

Stone look

Wood look

Collections ▼

Technical Specifications ▼

Colour Map

Stone Look

◀ 1 / 2



CANYON IVORY
P. 372



ARISE BEIGE
P. 306



CANYON SAND
P. 372



AVENUE TORTORA
P. 368



SENSE GREY
P. 48



CANYON GREY
P. 372



ARISE GREY
P. 307



AVENUE GREY
P. 368



AVENUE DARK GREY
P. 368

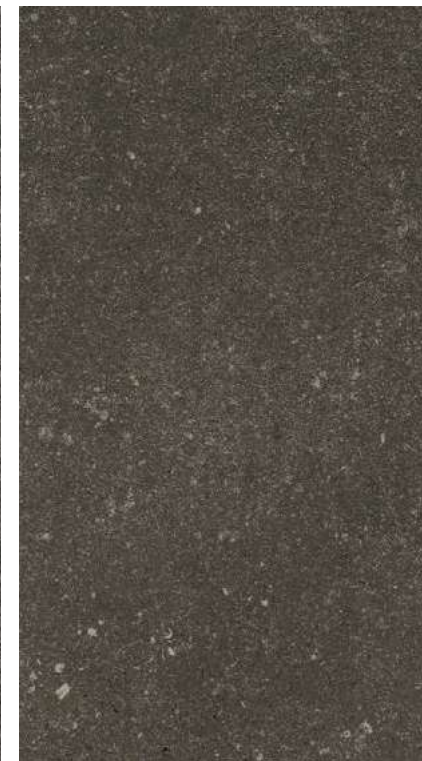

ARISE ANTHRACITE
P. 307

Colour Map

Stone Look

Index ▼

Colour Map ▼

Chromatic look

Concrete look

Marble look

Stone look

Wood look

Collections ▼

Technical Specifications ▼

Colour Map

Marble Look



MARBLE WHITE
P. 108



PRECIOUS CALACATTA
P. 90



MARBLE LIGHT GREY
P. 112



PRECIOUS CALACATTA GOLD
P. 88



MARBLE CREAM
P. 110



MARBLE BEIGE
P. 114



MARBLE TORTORA
P. 116

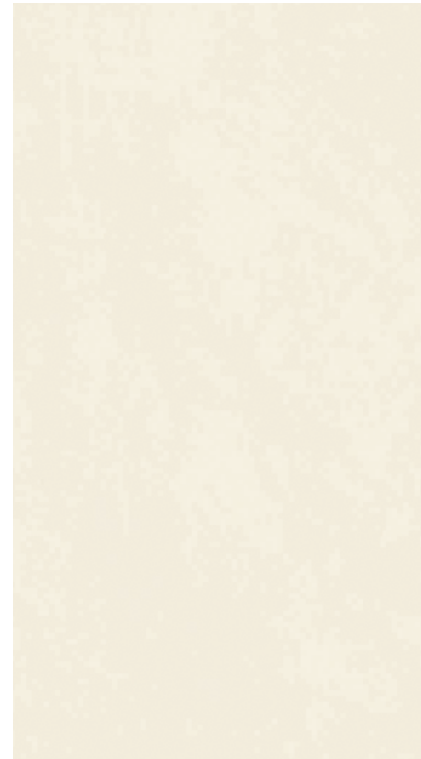

SPLASH CREAM
P. 212

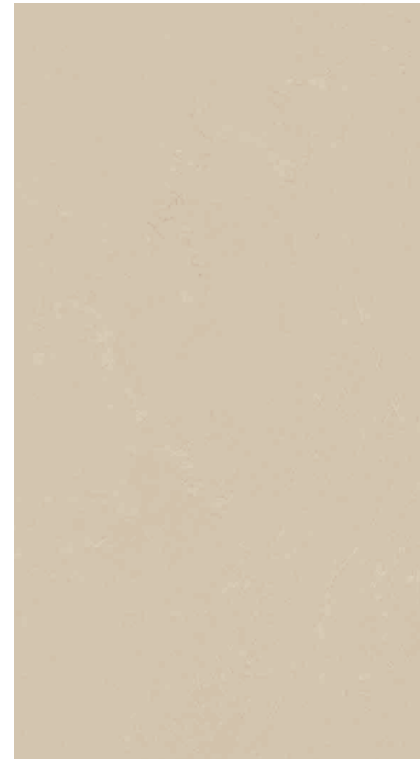

SPLASH GREY
P. 212

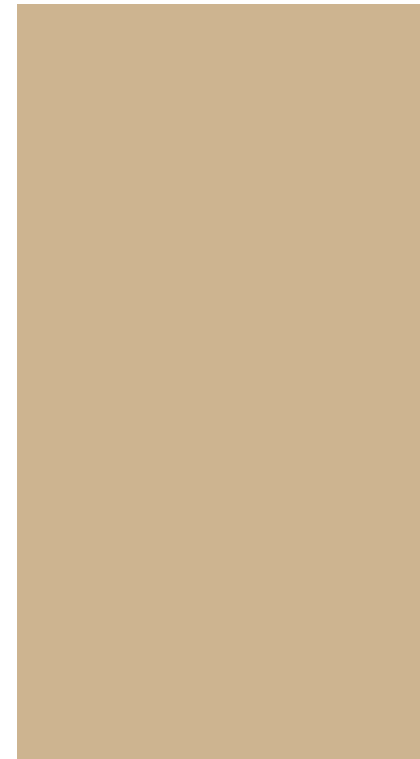

GENESIS SAND
P. 190



SPLASH TORTORA
P. 212

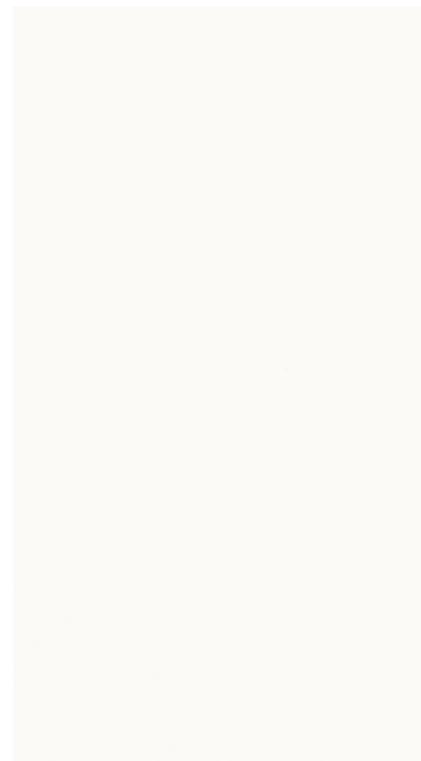

LIGHT BRANCO BRILHO
P. 224

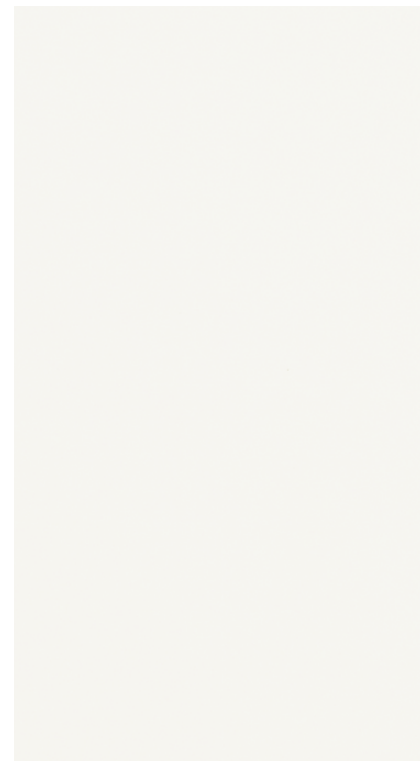

LIGHT MATT WHITE
P. 224

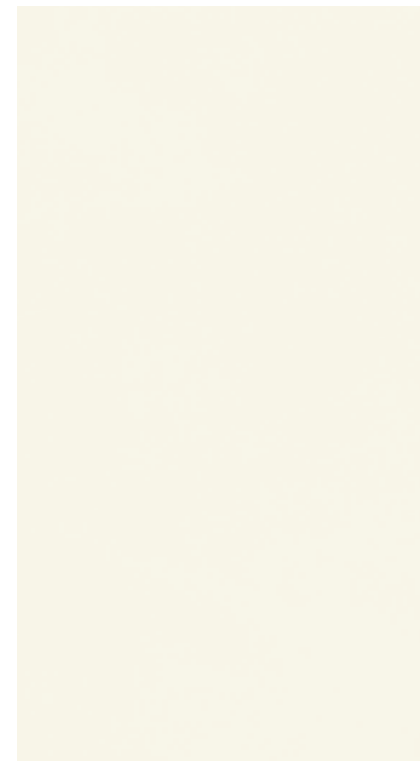

GENESIS WHITE MATT
P. 186



SPLASH WHITE
P. 212

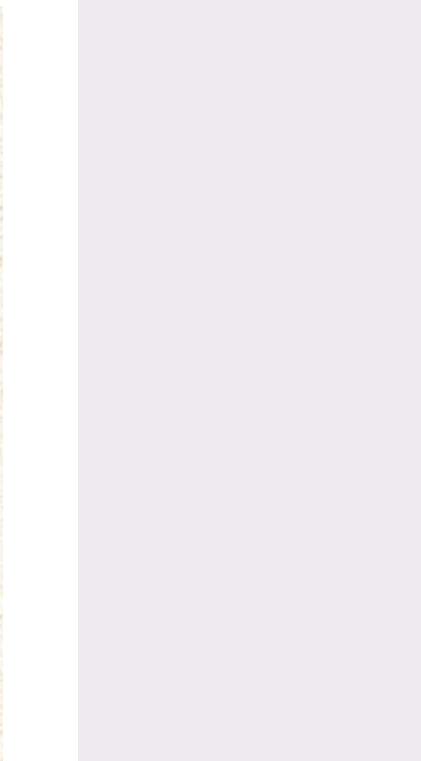

METALLIC PLATINUM
P. 68

Colour Map

Chromatic Look

1/2 ▶

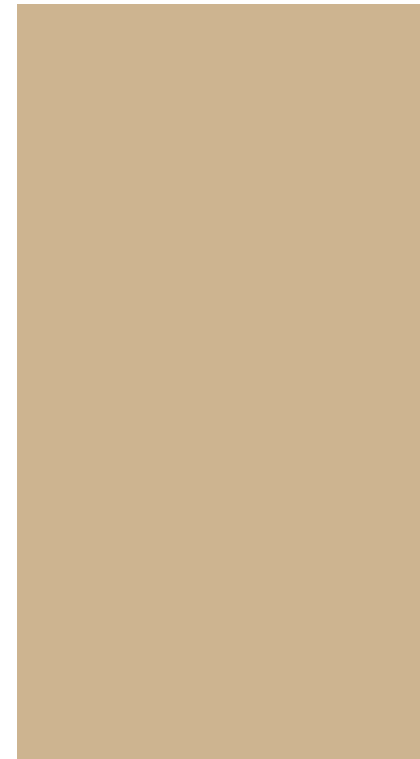
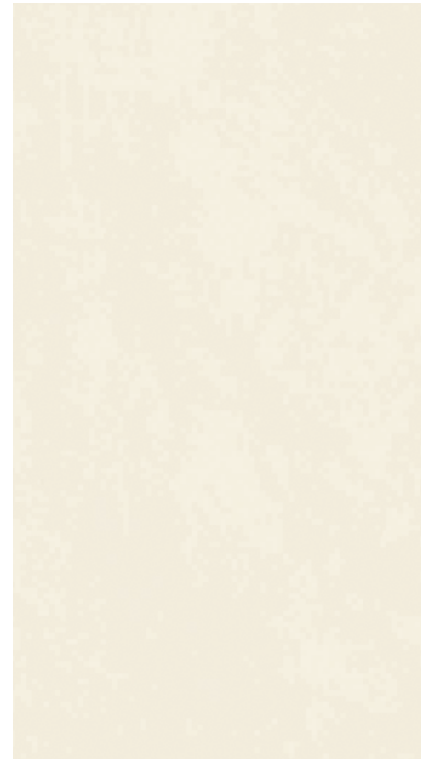

Colour Map ▼

Chromatic look

Concrete look

Marble look

Stone look

Wood look

Collections ▼

Technical Specifications ▼

Colour Map

Chromatic Look

◀ 1 / 2



METALLIC RUST
P. 68



METALLIC CORTEN
P. 68



SPLASH ORANGE
P. 212



GENESIS RED
P. 191



SPLASH RED
P. 212

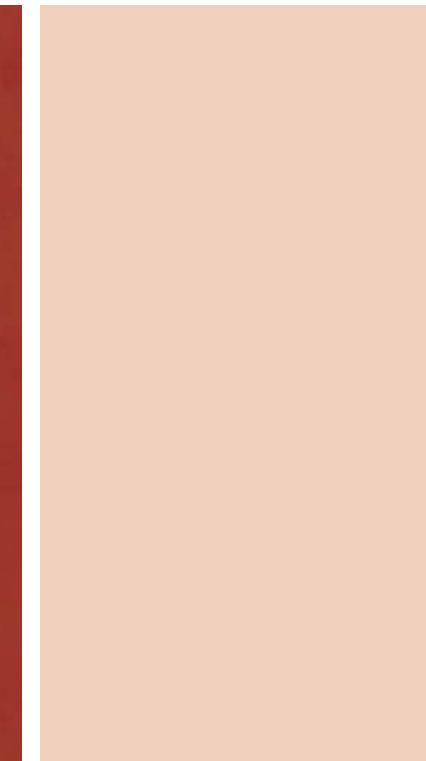

GENESIS PINK
P. 195



SPLASH GREEN
P. 212



GENESIS GREEN
P. 194



METALLIC STEEL
P. 68



METALLIC IRON
P. 68



SPLASH ANTHRACITE
P. 212



METALLIC CARBON
P. 68



GENESIS BLACK
P. 192

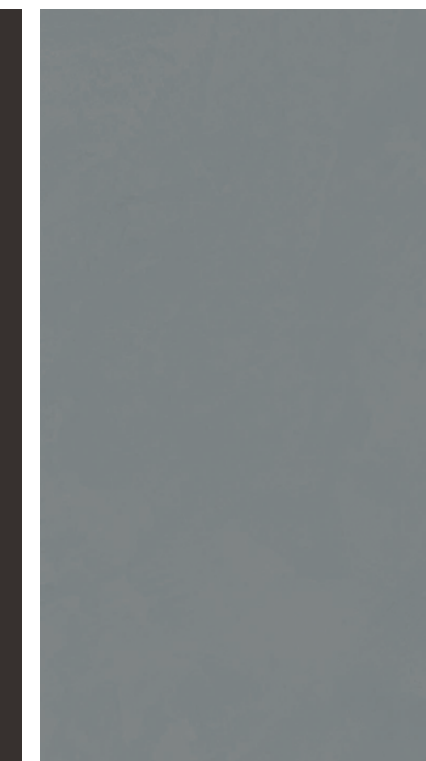

SPLASH BLUE
P. 212



GENESIS DEEP BLUE
P. 193



GENESIS MARINE BLUE
P. 195

Colour Map

Chromatic Look

Index ▼

Colour Map ▼

Chromatic look

Concrete look

Marble look

Stone look

Wood look

Collections ▼

Technical Specifications ▼



Exotic 35 x 100 Ret.
Sense Grey 35 x 100 Ret.
Sense Grey 60 x 60 Ret. In&Out

Sense

Collection

NEW

DOWNLOAD CATALOGUE  VIEW ONLINE 



35 x 70 · 35 x 100  8 mm



Coloured Body
PORCELAIN



80 x 80  9 mm

30 x 60 · 60 x 60  8 mm



PROTECT[®]
Antibacterial for Life.

LOVE
CERAMIC TILES

Index ▾

Colour Map ▾

Collections ▾

- Arise
- Avenue
- Balance
- Canyon
- Core
- Genesis
- Gravity
- Ground
- Light
- Marble
- Mémorable
- Metallic
- Native
- Nest
- Precious
- Pulse
- Sense**
- Splash
- Timber
- Urban
- Wooden

Technical Specifications ▾

Sense

Collection

NEW



Sense

Collection

NEW



Index ▾

Colour Map ▾

Collections ▾

- Arise
- Avenue
- Balance
- Canyon
- Core
- Genesis
- Gravity
- Ground
- Light
- Marble
- Mémorable
- Metallic
- Native
- Nest
- Precious
- Pulse
- Sense**
- Splash
- Timber
- Urban
- Wooden

Technical Specifications ▾

LOVE
CERAMIC TILES

Scratch Light Grey
35 x 100 Ret.

Sense Light Grey
35 x 100 Ret.

Sense Light Grey
80 x 80 Ret. Touch

Sense

Collection

NEW



Sense

Collection

NEW



Sense Light Grey
35 x 100 Ret.

Amazon Light Grey
35 x 100 Ret.

Sense Light Grey
80 x 80 Ret. Touch

Index ▾

Colour Map ▾

Collections ▾

- Arise
- Avenue
- Balance
- Canyon
- Core
- Genesis
- Gravity
- Ground
- Light
- Marble
- Mémorable
- Metallic
- Native
- Nest
- Precious
- Pulse
- Sense**
- Splash
- Timber
- Urban
- Wooden

Technical Specifications ▾

Sense

Collection

NEW



Sense Grey 35 x 70 Ret. Listelo Brushed Silver 0,5 x 100 Elevation Grey 35 x 70 Ret. Sense Grey 60 x 60 Ret. Touch



Sense

Collection

NEW

LOVE
CERAMIC TILES

Sense Light Grey 35 x 100 Ret. Mosaic Crystal Light Grey 35 x 35 Mosaic Sense Light Grey 35 x 35 In&Out Sense Light Grey 80 x 80 Ret. In&Out

Index ▾

Colour Map ▾

Collections ▾

- Arise
- Avenue
- Balance
- Canyon
- Core
- Genesis
- Gravity
- Ground
- Light
- Marble
- Mémorable
- Metallic
- Native
- Nest
- Precious
- Pulse
- Sense**
- Splash
- Timber
- Urban
- Wooden

Technical Specifications ▾

Sense

Collection

NEW



Sense

Collection

NEW



Index ▾

Colour Map ▾

Collections ▾

- Arise
- Avenue
- Balance
- Canyon
- Core
- Genesis
- Gravity
- Ground
- Light
- Marble
- Mémorable
- Metallic
- Native
- Nest
- Precious
- Pulse
- Sense**
- Splash
- Timber
- Urban
- Wooden

Technical Specifications ▾

Sense

Collection

NEW



Sense

Collection

NEW

Index ▾

Colour Map ▾

Collections ▾

- Arise
- Avenue
- Balance
- Canyon
- Core
- Genesis
- Gravity
- Ground
- Light
- Marble
- Mémorable
- Metallic
- Native
- Nest
- Precious
- Pulse
- Sense**
- Splash
- Timber
- Urban
- Wooden

Technical Specifications ▾

LOVE
CERAMIC TILES

Exotic Green
35 x 100 Ret.

Sense Beige
35 x 100 Ret.

Sense Beige
80 x 80 Ret. Touch

Sense

Collection

NEW



Floral 35 x 100 Ret. Sense White 35 x 100 Ret. Sense White 80 x 80 Ret. Touch

Sense

Collection

NEW

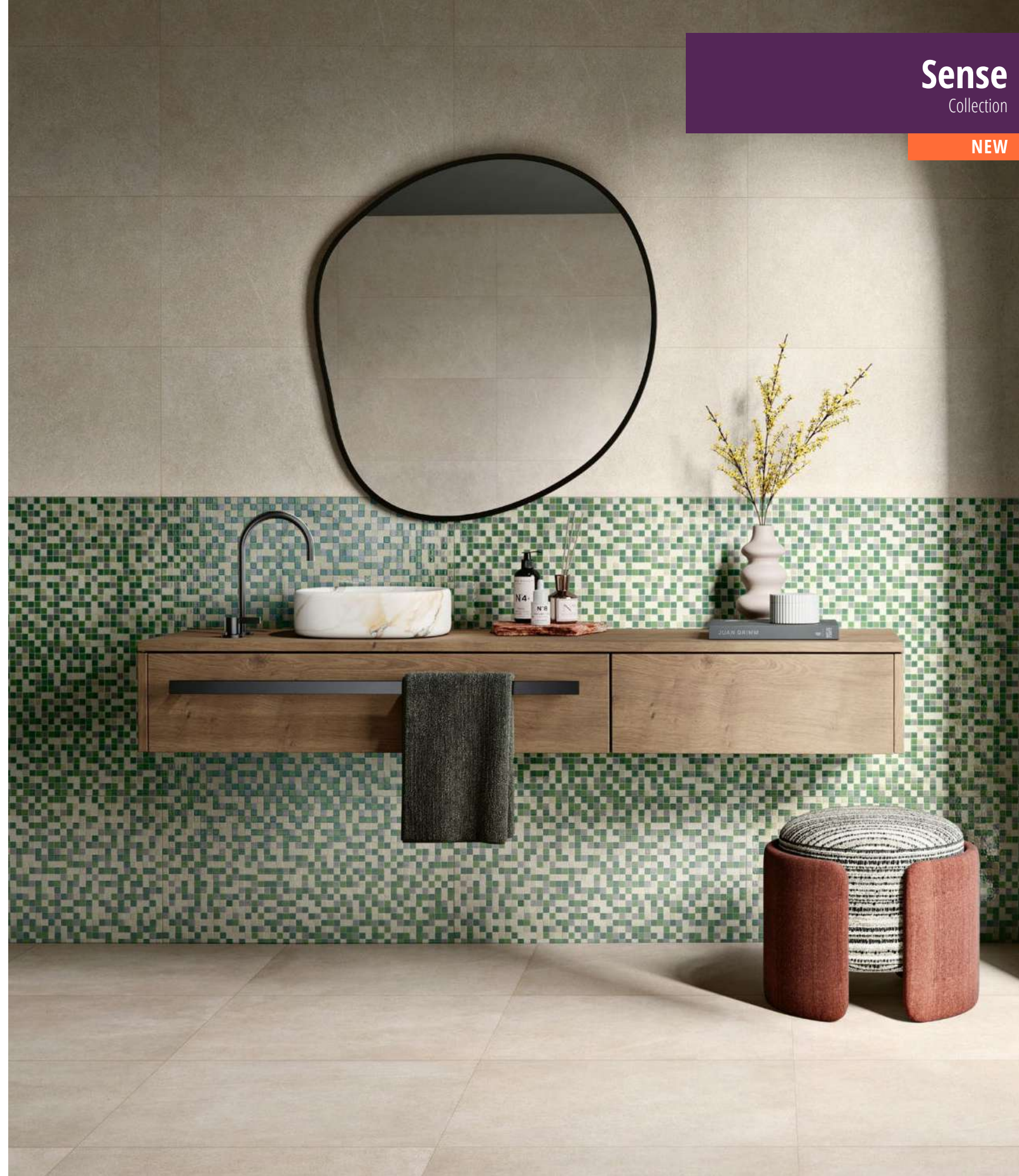

Sense White 35 x 70 Ret. Bitmap Green 35 x 70 Ret. Sense White 60 x 60 Ret. Touch

Index ▾

Colour Map ▾

Collections ▾

- Arise
- Avenue
- Balance
- Canyon
- Core
- Genesis
- Gravity
- Ground
- Light
- Marble
- Mémorable
- Metallic
- Native
- Nest
- Precious
- Pulse
- Sense**
- Splash
- Timber
- Urban
- Wooden

Technical Specifications ▾

LOVE
CERAMIC TILES

Sense

Collection

NEW

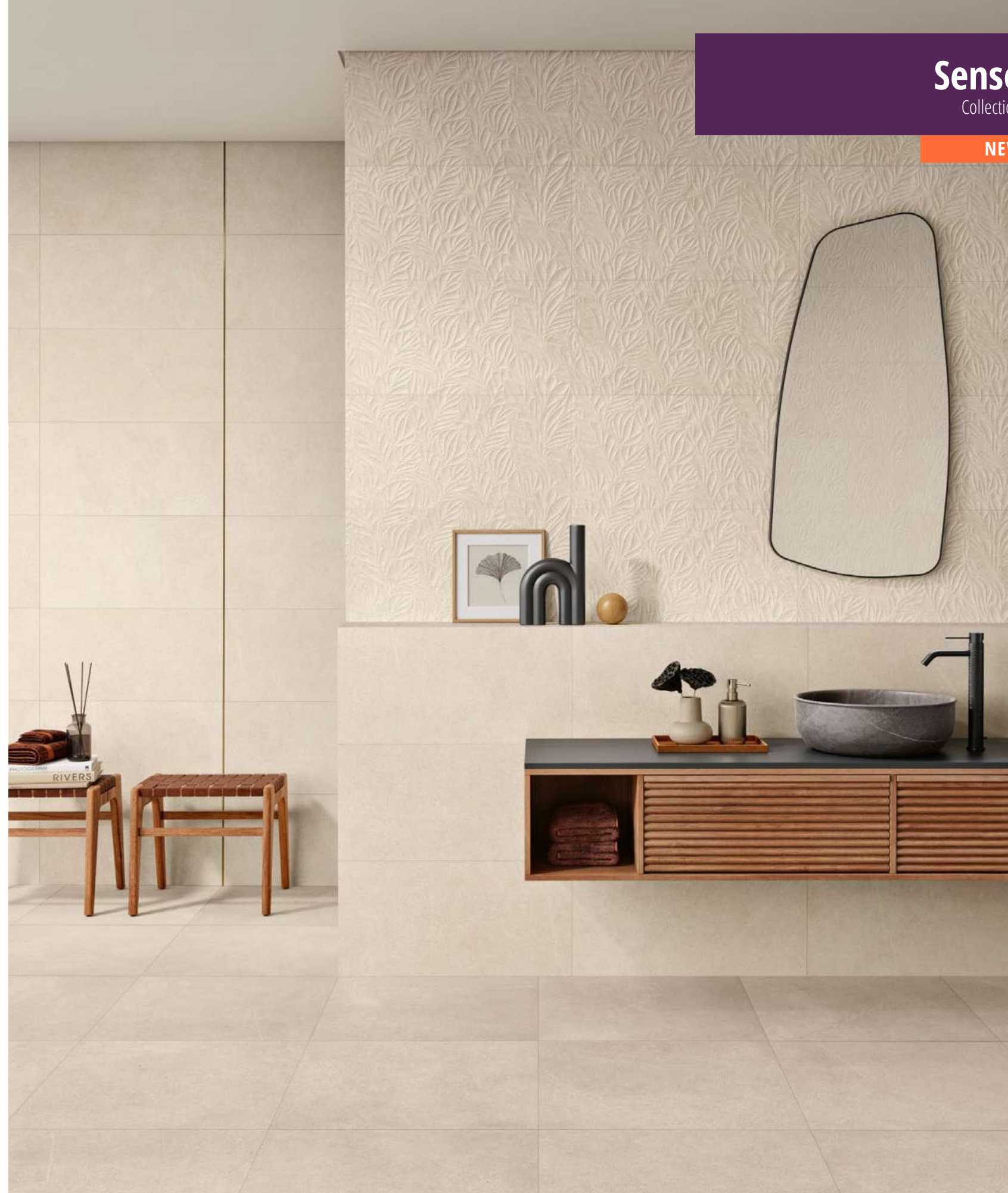

Sense

Collection

NEW

Index ▾

Colour Map ▾

Collections ▾

- Arise
- Avenue
- Balance
- Canyon
- Core
- Genesis
- Gravity
- Ground
- Light
- Marble
- Mémorable
- Metallic
- Native
- Nest
- Precious
- Pulse
- Sense**
- Splash
- Timber
- Urban
- Wooden

Technical Specifications ▾

LOVE
CERAMIC TILES

Sense Beige
35 x 70 Ret.

Listelo Brushed Gold
0,5 x 100

Botanic Beige
35 x 70 Ret.

Sense Beige
60 x 60 Ret. In&Out

Sense

Collection

NEW



Sense

Collection

NEW



Index ▾

Colour Map ▾

Collections ▾

- Arise
- Avenue
- Balance
- Canyon
- Core
- Genesis
- Gravity
- Ground
- Light
- Marble
- Mémorable
- Metallic
- Native
- Nest
- Precious
- Pulse
- Sense**
- Splash
- Timber
- Urban
- Wooden

Technical Specifications ▾

LOVE
CERAMIC TILES

Garden
35 x 70 Ret.

Sense White
35 x 70 Ret.

Sense White
60 x 60 Ret. Touch

Sense

Collection

NEW

Sense

Collection

NEW



Index ▾

Colour Map ▾

Collections ▾

- Arise
- Avenue
- Balance
- Canyon
- Core
- Genesis
- Gravity
- Ground
- Light
- Marble
- Mémorable
- Metallic
- Native
- Nest
- Precious
- Pulse
- Sense**
- Splash
- Timber
- Urban
- Wooden

Technical Specifications ▾

Sense

Collection

NEW



Sense Beige
80 x 80 Ret. Touch

Sense

Collection

NEW



Sense Grey
80 x 80 Ret. Touch

Index ▾

Colour Map ▾

Collections ▾

- Arise
- Avenue
- Balance
- Canyon
- Core
- Genesis
- Gravity
- Ground
- Light
- Marble
- Mémorable
- Metallic
- Native
- Nest
- Precious
- Pulse
- Sense**
- Splash
- Timber
- Urban
- Wooden

Technical Specifications ▾

Sense

Collection

NEW

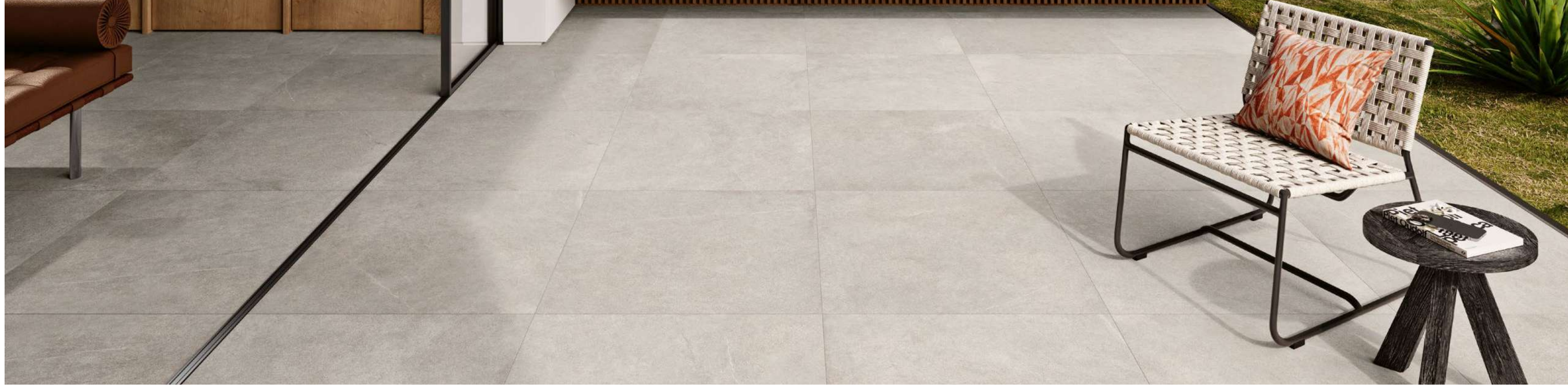

Sense

Collection

NEW

Index ▾

Colour Map ▾

Collections ▾

- Arise
- Avenue
- Balance
- Canyon
- Core
- Genesis
- Gravity
- Ground
- Light
- Marble
- Mémorable
- Metallic
- Native
- Nest
- Precious
- Pulse
- Sense**
- Splash
- Timber
- Urban
- Wooden

Technical Specifications ▾



35x100 - 35x70 - 8 mm



SENSE WHITE

35x100 Ret. **LT-8050**
35x70 Ret. **LT-7400**



SENSE BEIGE

35x100 Ret. **LT-8050**
35x70 Ret. **LT-7400**

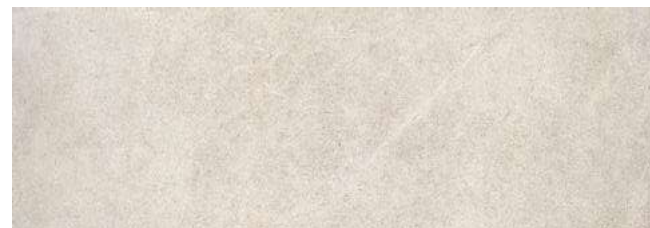

SENSE LIGHT GREY

35x100 Ret. **LT-8050**
35x70 Ret. **LT-7400**



SENSE GREY

35x100 Ret. **LT-8050**
35x70 Ret. **LT-7400**



Coloured Body
PORCELAIN

80x80 - 9 mm | 60x60 - 30x60 - 8 mm



SENSE WHITE

80x80 Ret. Touch **LT-2870**
80x80 Ret. In&Out **LT-2870**
60x60 Ret. Touch **LT-2450**
60x60 Ret. In&Out **LT-2450**
30x60 Ret. In&Out **LT-1840**



SENSE BEIGE

80x80 Ret. Touch **LT-2870**
80x80 Ret. In&Out **LT-2870**
60x60 Ret. Touch **LT-2450**
60x60 Ret. In&Out **LT-2450**
30x60 Ret. In&Out **LT-1840**



SENSE LIGHT GREY

80x80 Ret. Touch **LT-2870**
80x80 Ret. In&Out **LT-2870**
60x60 Ret. Touch **LT-2450**
60x60 Ret. In&Out **LT-2450**
30x60 Ret. In&Out **LT-1840**



SENSE GREY

80x80 Ret. Touch **LT-2870**
80x80 Ret. In&Out **LT-2870**
60x60 Ret. Touch **LT-2450**
60x60 Ret. In&Out **LT-2450**
30x60 Ret. In&Out **LT-1840**

PR()TECT®

Antibacterial for Life.

Uma linha exclusiva de pavimentos e revestimentos antimicrobianos de altíssima performance, projetada para ambientes saudáveis, seguros e protegidos. Por favor consulte a página 374.

An exclusive line of extremely high performance antimicrobial floor and wall tiles, designed for healthy, safe and protected living spaces. Please see page 374.

Une ligne exclusive de sols et revêtements antibactériens aux performances très élevées, pour un habitat sain, sûr et protégé. Veuillez-vous consulter la page 374.

Eine exklusive Linie an hochwertigen Fußböden und antibakteriellen Wandverkleidungen, für ein gesundes, sicheres und geschütztes Leben. Bitte beachten Sie Seite 374.

Эксклюзивная линия высокоэффективных противомикробных покрытий, предназначенных для здоровой, безопасной и защищенной окружающей среды. Пожалуйста, посмотрите информацию на странице 374.

Una linea esclusiva di pavimenti e rivestimenti antimicrobici ad altissime prestazioni, ideata per ambienti abitativi sani, sicuri e protetti. Si prega di fare riferimento alla pagina 374.

- Arise
- Avenue
- Balance
- Canyon
- Core
- Genesis
- Gravity
- Ground
- Light
- Marble
- Mémorable
- Metallic
- Native
- Nest
- Precious
- Pulse
- Sense**
- Splash
- Timber
- Urban
- Wooden



7,7 - 8,1 mm



SCRATCH WHITE
35x100 Ret. **LT-8405**

7,6 - 7,8 mm



AMAZON WHITE
35x100 Ret. **LT-8405**



SCRATCH BEIGE
35x100 Ret. **LT-8405**



AMAZON BEIGE
35x100 Ret. **LT-8405**



SCRATCH LIGHT GREY
35x100 Ret. **LT-8405**



AMAZON LIGHT GREY
35x100 Ret. **LT-8405**



SCRATCH GREY
35x100 Ret. **LT-8405**



AMAZON GREY
35x100 Ret. **LT-8405**



8 mm



CHANNEL WHITE*
35x100 Ret. **LP-6435**



CHANNEL BEIGE*
35x100 Ret. **LP-6435**



CHANNEL LIGHT GREY**
35x100 Ret. **LP-6435**



CHANNEL GREY**
35x100 Ret. **LP-6435**

* Inseto de madeira: Native Dark Beige
Wood insert: Native Dark Beige
Insert Bois: Native Dark Beige
Holzprofil eingefügt: Native Dark Beige
Вставка из дерева: Native Dark Beige
Inseto effetto legno: Native Dark Beige

** Inseto de madeira: Native Tortora
Wood insert: Native Tortora
Insert Bois: Native Tortora
Holzprofil eingefügt: Native Tortora
Вставка из дерева: Native Tortora
Inseto effetto legno: Native Tortora

- Arise
- Avenue
- Balance
- Canyon
- Core
- Genesis
- Gravity
- Ground
- Light
- Marble
- Mémorable
- Metallic
- Native
- Nest
- Precious
- Pulse
- Sense**
- Splash
- Timber
- Urban
- Wooden



8 mm



EXOTIC GREEN
35x100 Ret. **LT-8405**



EXOTIC
35x100 Ret. **LT-8405**

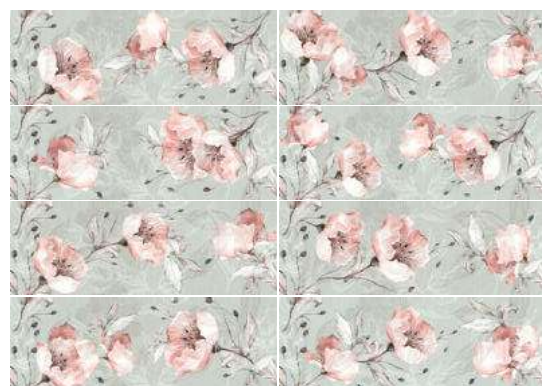

FLORAL
35x100 Ret. **LT-8405**

Exemplo de composição das 8 peças. Os diferentes desenhos são embalados aleatoriamente.
 Example of composition of the 8 pieces. The available patterns are packed randomly.
 Exemple de composition des 8 pièces. Les différents motifs sont emballés aléatoirement.
 Beispiel für die Komposition der 8 Stück. Die verschiedenen Grafiken sind aleatorisch eingepackt.
 Пример композиции из 8 штук. Доступные дизайны упакованы в случайном порядке.
 Esempio do composizione a 8 pt. L acquisto è a scatole con imballo misto.



7,2 - 8,7 mm



BOTANIC WHITE
35x70 Ret. **LT-7700**



BOTANIC BEIGE
35x70 Ret. **LT-7700**



BOTANIC LIGHT GREY
35x70 Ret. **LT-7700**



BOTANIC GREY
35x70 Ret. **LT-7700**

7,3 - 8,8 mm



ELEVATION WHITE
35x70 Ret. **LT-7700**



ELEVATION BEIGE
35x70 Ret. **LT-7700**



ELEVATION LIGHT GREY
35x70 Ret. **LT-7700**



ELEVATION GREY
35x70 Ret. **LT-7700**



- Arise
- Avenue
- Balance
- Canyon
- Core
- Genesis
- Gravity
- Ground
- Light
- Marble
- Mémorable
- Metallic
- Native
- Nest
- Precious
- Pulse
- Sense**
- Splash
- Timber
- Urban
- Wooden



8 mm



m²

GARDEN
35x70 Ret. **LT-7700**



Exemplo de composição das 6 peças. Os diferentes desenhos são embalados aleatoriamente.
Example of composition of the 6 pieces. The available patterns are packed randomly.
Exemple de composition des 6 pièces. Les différents motifs sont emballés aléatoirement.
Beispiel für die Komposition der 6 Stück. Die verschiedenen Grafiken sind aleatorisch eingepackt.
Пример композиции из 6 штук. Доступные дизайны упакованы в случайном порядке.
Esempio di composizione a 6 pz. L'acquisto è a scatole con imballo misto.

8 mm

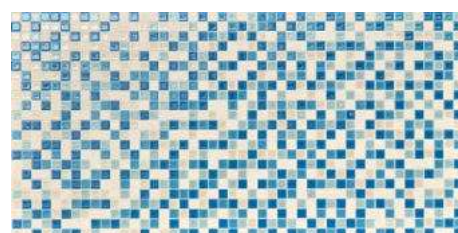

BITMAP BLUE
35x70 Ret. **LP-6450**



BITMAP GREEN
35x70 Ret. **LP-6450**



BITMAP
35x70 Ret. **LP-6450**

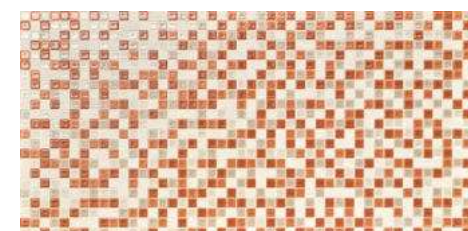

BITMAP RED
35x70 Ret. **LP-6450**



8 mm

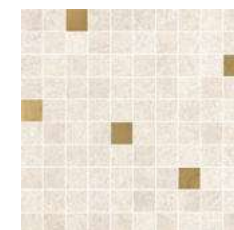

MOSAIC CRYSTAL WHITE
35x35 (3,3x3,3) **LP-6310**



MOSAIC CRYSTAL BEIGE
35x35 (3,3x3,3) **LP-6310**

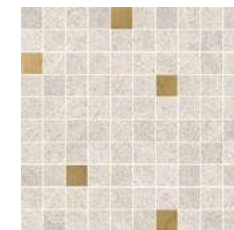

MOSAIC CRYSTAL LIGHT GREY
35x35 (3,3x3,3) **LP-6310**

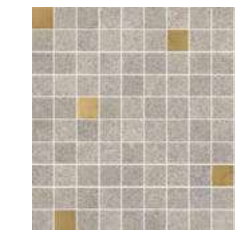

MOSAIC CRYSTAL GREY
35x35 (3,3x3,3) **LP-6310**

LISTELO BRUSHED GOLD
0,5x1,1x100 **LP-6420**
0,5x1,1x70 **LP-6370**

LISTELO BRUSHED SILVER
0,5x1,1x100 **LP-6348**
0,5x1,1x70 **LP-6310**

✕ **LISTELO SHINE SILVER**
0,5x1,1x100 **LP-6348**
0,5x1,1x70 **LP-6310**

LISTELO BRUSHED BRONZE
0,5x1,1x100 **LP-6420**
0,5x1,1x70 **LP-6370**



Listelo Brushed
Listelo Shine



- Arise
- Avenue
- Balance
- Canyon
- Core
- Genesis
- Gravity
- Ground
- Light
- Marble
- Mémorable
- Metallic
- Native
- Nest
- Precious
- Pulse
- Sense**
- Splash
- Timber
- Urban
- Wooden



8 mm

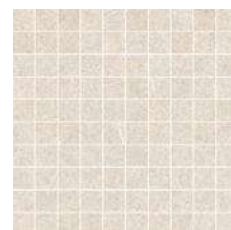

MOSAIC SENSE WHITE
35x35 In&Out LP-6250



MOSAIC SENSE BEIGE
35x35 In&Out LP-6250

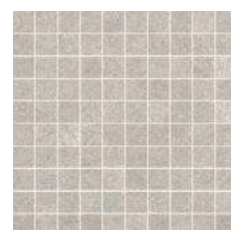

MOSAIC SENSE LIGHT GREY
35x35 In&Out LP-6250



MOSAIC SENSE GREY
35x35 In&Out LP-6250

Coloured Body
PORCELAIN

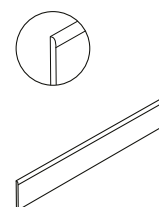

Rodapé Sense
Skirting Sense
Plinthe Sense
Sockel Sense
Плинтуса Sense
Battiscopa Sense

8x80 Ret. Touch LP-6130
8x60 Ret. Touch LP-6075

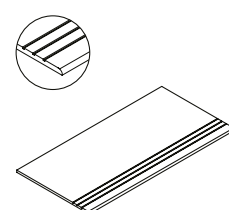

Degrau Sulcado
Step Tread Grooved
Nez De Marche Creusé
Stufenplatte Mit Rillen
Ступень С Насечками
Gradino Con Solchi

30x80 Ret. Touch LP-6490
30x80 Ret. In&Out LP-6490
30x60 Ret. Touch LP-6350
30x60 Ret. In&Out LP-6350

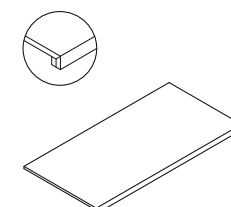

Degrau Espessurado
Step Extra Fluted
Nez De Marche Forte Épaisseur
Massive Stufenplatte
Ступень Утолщенная
Gradino Spessorato

30x80 Ret. Touch LP-6590
30x80 Ret. In&Out LP-6590
30x60 Ret. Touch LP-6560
30x60 Ret. In&Out LP-6560

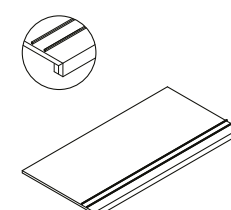

Degrau Espessurado Inox
Step Extra Thick Inox
Nez De Marche Forte Épaisseur Inox
Massive Stufenplatte Inox
Ступень Утолщенная С Металлическими Вставками
Gradino Spessorato Inox

30x80 Ret. Touch LP-6620
30x80 Ret. In&Out LP-6620
30x60 Ret. Touch LP-6580
30x60 Ret. In&Out LP-6580

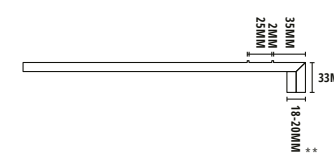

30x80 · 8x80 · 9 mm | 30x60 · 8x60 · 8 mm

PEÇAS ESPECIAIS | SPECIAL PIECES | PIÈCES SPÉCIALES | SPEZIALTEILE | СПЕЦИАЛЬНЫЕ ИЗДЕЛИЯ | PEZZI SPECIALI

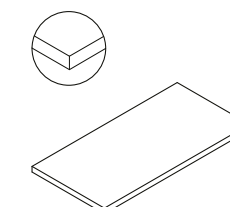

* Degrau Espessurado Canto
Step Extra Thick Corner
Nez De Marche Forte Épaisseur Angle
Ecke massive stufenplatte
Угловая ступень утолщенная
Angolo gradino spessorato

30x80 Ret. Touch LP-6670
30x80 Ret. In&Out LP-6670
30x60 Ret. Touch LP-6630
30x60 Ret. In&Out LP-6630

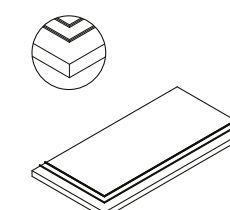

* Degrau Espessurado Canto Inox
Step Extra Thick Corner Inox
Nez De Marche Forte Épaisseur Angle Inox
Ecke massive stufenplatte inox
Угловая ступень утолщенная с металлическими вставками
Angolo gradino spessorato inox

30x80 Ret. Touch LP-6690
30x80 Ret. In&Out LP-6690
30x60 Ret. Touch LP-6650
30x60 Ret. In&Out LP-6650

*Disponível no canto direito e esquerdo - Available in right and left corner - Disponible dans les coin droit et gauche
Erhältlich in der rechten Ecke und links - Доступна как правая так и левая угловая ступень - Disponibile nell'angolo destro e sinistro

**A dimensão varia consoante a espessura do material cerâmico - Dimension will vary depending on the base tile thickness - La dimension varie selon l'épaisseur du carreau
Das Maß variiert je nach Dicke der Fliese - Размер варьируется в зависимости от толщины керамического материала - La dimensione varia a seconda dello spessore della piastrella di base

- Arise
- Avenue
- Balance
- Canyon
- Core
- Genesis
- Gravity
- Ground
- Light
- Marble
- Mémorable
- Metallic
- Native
- Nest
- Precious
- Pulse
- Sense**
- Splash
- Timber
- Urban
- Wooden



Metallic Carbon 45 x 120 Ret. Listelo Blink brushed Bronze 0,5 x 120 Metallic Carbon 60 x 60 Ret.

Metallic

Collection

DOWNLOAD CATALOGUE VIEW ONLINE



45 x 120 9,5 mm
35 x 100 8 mm

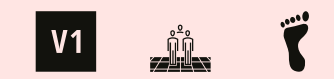
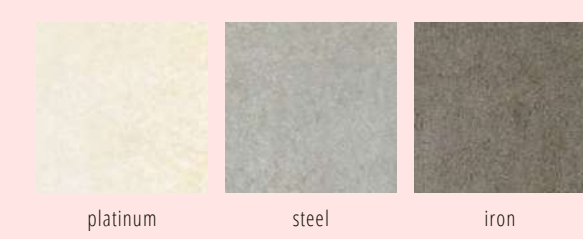

60 x 60 8 mm

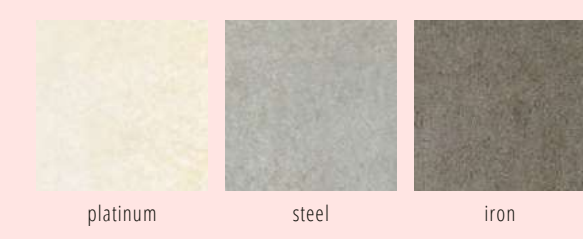

Index ▾

Colour Map ▾

Collections ▾

- Arise
- Avenue
- Balance
- Canyon
- Core
- Genesis
- Gravity
- Ground
- Light
- Marble
- Mémorable
- Metallic**
- Native
- Nest
- Precious
- Pulse
- Sense
- Splash
- Timber
- Urban
- Wooden

Technical Specifications ▾

Metallic

Collection



Metallic

Collection



Index ▾

Colour Map ▾

Collections ▾

- Arise
- Avenue
- Balance
- Canyon
- Core
- Genesis
- Gravity
- Ground
- Light
- Marble
- Mémorable
- Metallic**
- Native
- Nest
- Precious
- Pulse
- Sense
- Splash
- Timber
- Urban
- Wooden

Technical Specifications ▾

Metallic

Collection



Metallic

Collection



Index ▼

Colour Map ▼

Collections ▼

- Arise
- Avenue
- Balance
- Canyon
- Core
- Genesis
- Gravity
- Ground
- Light
- Marble
- Mémorable
- Metallic**
- Native
- Nest
- Precious
- Pulse
- Sense
- Splash
- Timber
- Urban
- Wooden

Technical Specifications ▼

LOVE
CERAMIC TILES

Metallic Iron
45 x 120 Ret.

Metallic Chess Iron
45 x 120 Ret.

Metallic Steel
60 x 60 Ret.

Metallic

Collection



Metallic

Collection

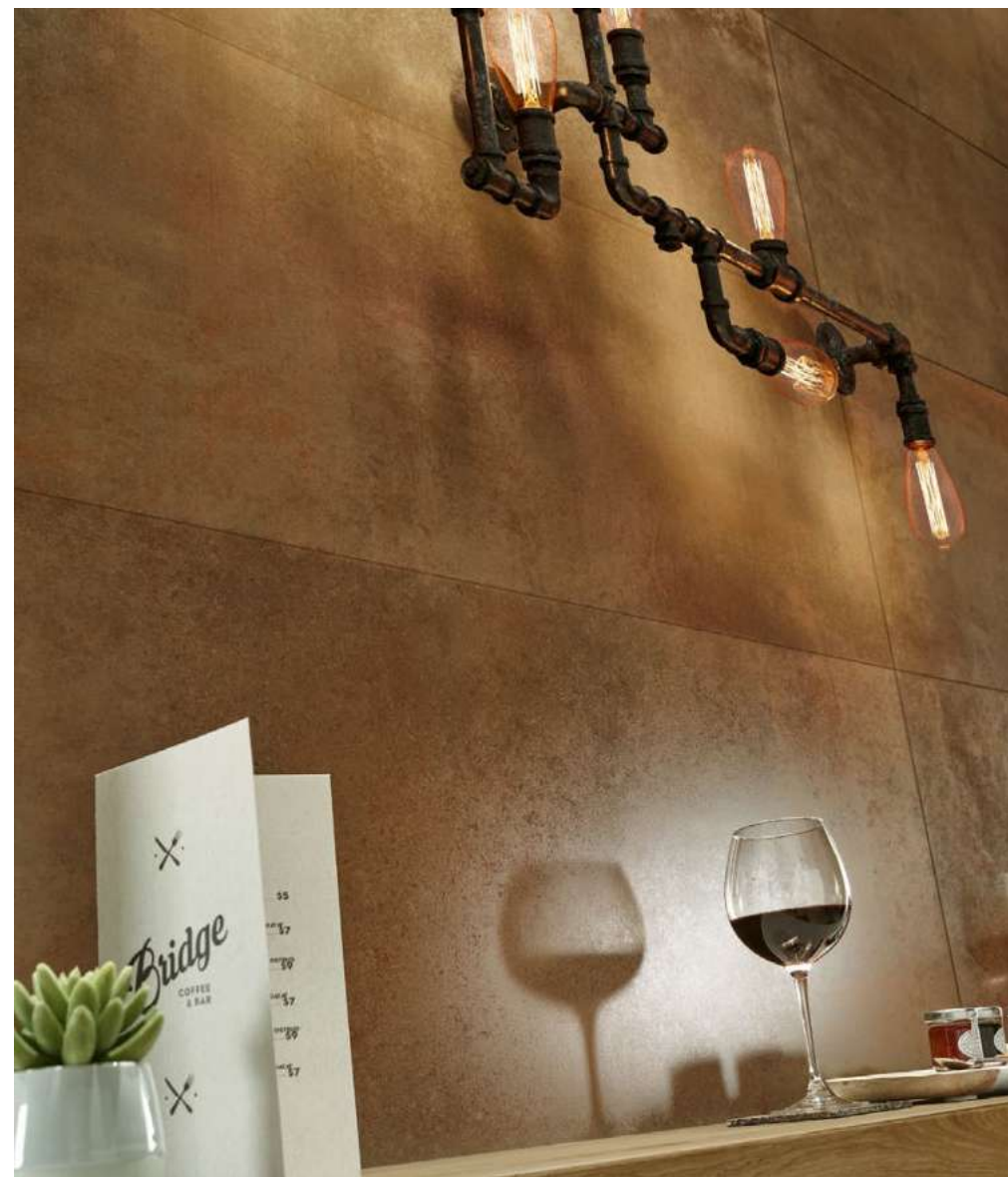

Index ▼

Colour Map ▼

Collections ▼

- Arise
- Avenue
- Balance
- Canyon
- Core
- Genesis
- Gravity
- Ground
- Light
- Marble
- Mémorable
- Metallic**
- Native
- Nest
- Precious
- Pulse
- Sense
- Splash
- Timber
- Urban
- Wooden

LOVE
CERAMIC TILES

Metallic Corten
45 x 120 Ret.

Timber Beige
20 x 100

Technical Specifications ▼

Metallic

Collection



Metallic

Collection

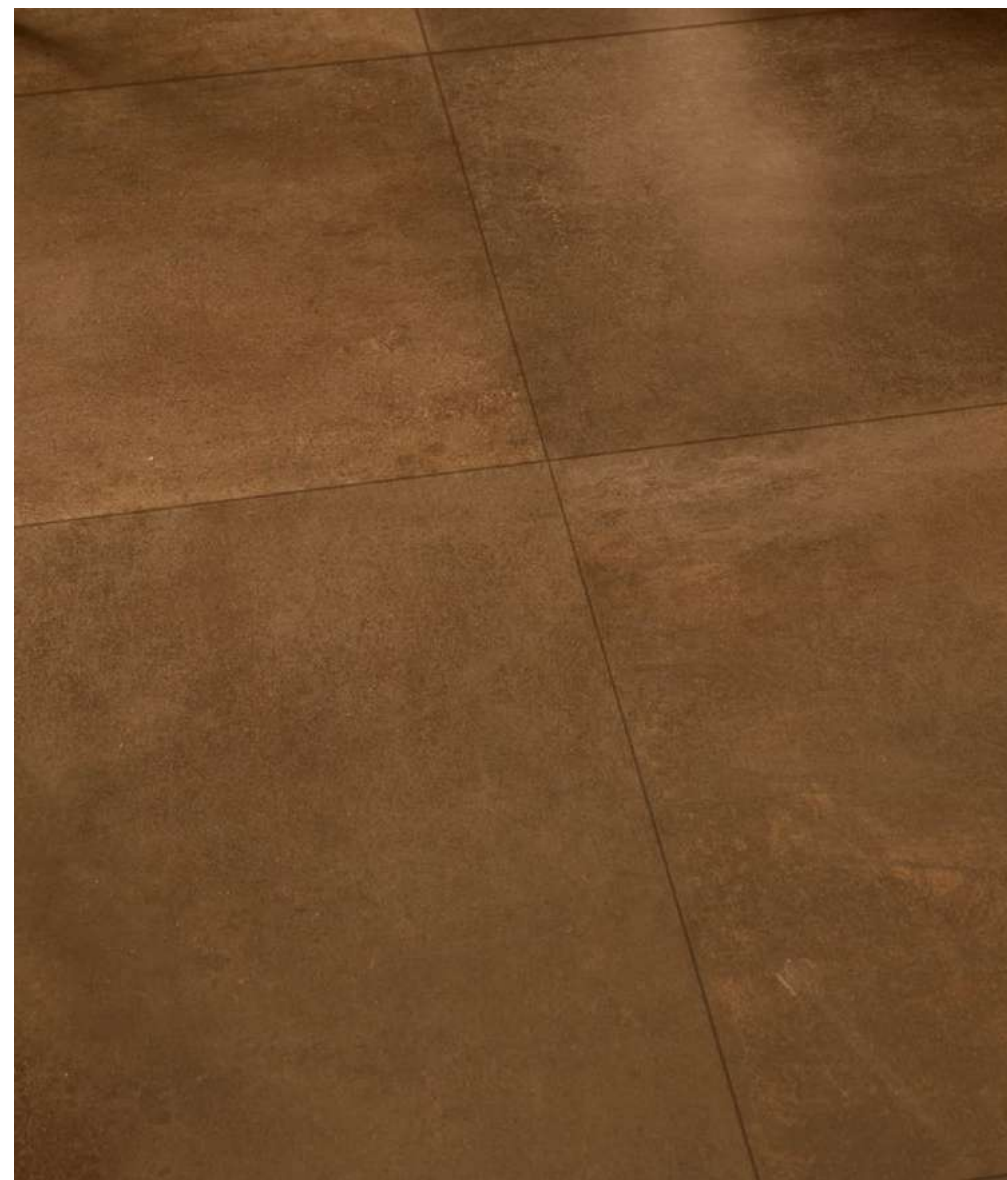
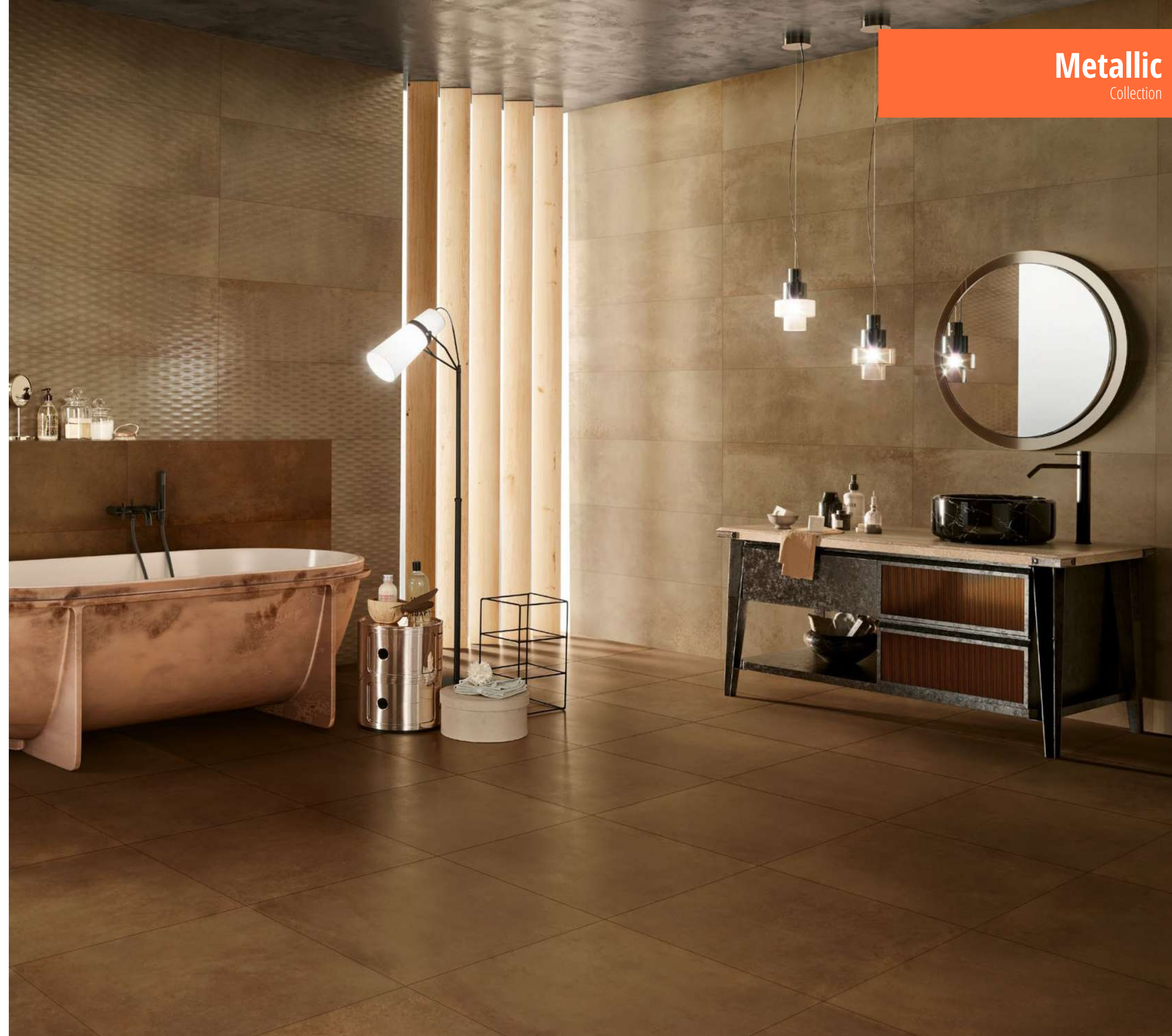

Index ▼

Colour Map ▼

Collections ▼

- Arise
- Avenue
- Balance
- Canyon
- Core
- Genesis
- Gravity
- Ground
- Light
- Marble
- Mémorable
- Metallic**
- Native
- Nest
- Precious
- Pulse
- Sense
- Splash
- Timber
- Urban
- Wooden

Technical Specifications ▼

LOVE
CERAMIC TILES

Metallic Grain Rust
35 x 100 Ret.

Metallic Corten
35 x 100 Ret.

Metallic Rust
35 x 100 Ret.

Metallic Corten
60 x 60 Ret.

Metallic

Collection



45x120 x 9,5 mm | 35x100 x 8 mm



METALLIC PLATINUM

45x120 Ret. **LT-8650**
35x100 Ret. **LT-8050**



METALLIC STEEL

45x120 Ret. **LT-8650**
35x100 Ret. **LT-8050**



METALLIC RUST

45x120 Ret. **LT-8650**
35x100 Ret. **LT-8050**



METALLIC IRON

45x120 Ret. **LT-8650**
35x100 Ret. **LT-8050**



METALLIC CORTEN

45x120 Ret. **LT-8870**
35x100 Ret. **LT-8305**



METALLIC CARBON

45x120 Ret. **LT-8870**
35x100 Ret. **LT-8305**

Metallic

Collection



8 mm



METALLIC PLATINUM

60x60 Ret. **LT-2400**



METALLIC STEEL

60x60 Ret. **LT-2400**



METALLIC RUST

60x60 Ret. **LT-2400**



METALLIC IRON

60x60 Ret. **LT-2400**



METALLIC CORTEN

60x60 Ret. **LT-2400**



METALLIC CARBON

60x60 Ret. **LT-2400**

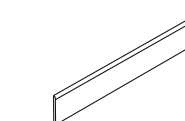

RODAPÉ METALLIC

8x60 Ret. **LP-6075**

Index

Colour Map

Collections

- Arise
- Avenue
- Balance
- Canyon
- Core
- Genesis
- Gravity
- Ground
- Light
- Marble
- Mémorable
- Metallic**
- Native
- Nest
- Precious
- Pulse
- Sense
- Splash
- Timber
- Urban
- Wooden

Technical Specifications

Metallic

Collection



10,1 - 11,4 mm



m²

CHESS PLATINUM
45x120 Ret. **LT-8910**



m²

CHESS RUST
45x120 Ret. **LT-8910**



m²

CHESS CORTEN
45x120 Ret. **LT-8970**



m²

CHESS IRON
45x120 Ret. **LT-8910**



m²

CHESS CARBON
45x120 Ret. **LT-8970**



Metallic

Collection



9,5 mm



TRACK PLATINUM
45x120 Ret. **LP-6650**



TRACK STEEL
45x120 Ret. **LP-6650**



TRACK RUST
45x120 Ret. **LP-6650**



TRACK IRON
45x120 Ret. **LP-6650**



TRACK CORTEN
45x120 Ret. **LP-6650**



TRACK CARBON
45x120 Ret. **LP-6650**

Index ▾

Colour Map ▾

Collections ▾

- Arise
- Avenue
- Balance
- Canyon
- Core
- Genesis
- Gravity
- Ground
- Light
- Marble
- Mémorable
- Metallic**
- Native
- Nest
- Precious
- Pulse
- Sense
- Splash
- Timber
- Urban
- Wooden

Technical Specifications ▾

Metallic

Collection



8,7 - 9,9 mm



GRAIN PLATINUM
35x100 Ret. LT-8340



GRAIN RUST
35x100 Ret. LT-8340



GRAIN IRON
35x100 Ret. LT-8340



GRAIN CORTEN
35x100 Ret. LT-8360



GRAIN CARBON
35x100 Ret. LT-8360



TRAME PLATINUM
35x100 Ret. LP-6540



TRAME RUST
35x100 Ret. LP-6540



TRAME CORTEN
35x100 Ret. LP-6540



TRAME STEEL
35x100 Ret. LP-6540



TRAME IRON
35x100 Ret. LP-6540



TRAME CARBON
35x100 Ret. LP-6540

Metallic

Collection



8 mm

Index ▾

Colour Map ▾

Collections ▾

- Arise
- Avenue
- Balance
- Canyon
- Core
- Genesis
- Gravity
- Ground
- Light
- Marble
- Mémorable
- Metallic**
- Native
- Nest
- Precious
- Pulse
- Sense
- Splash
- Timber
- Urban
- Wooden

Technical Specifications ▾

Metallic

Collection



9,5 mm

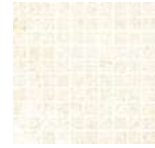

MOSAIC LEX PLATINUM
22,5x22,5 (2,1x2,1) LP-6240

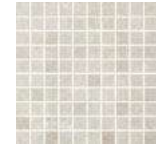

MOSAIC LEX STEEL
22,5x22,5 (2,1x2,1) LP-6240

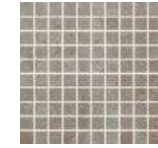

MOSAIC LEX IRON
22,5x22,5 (2,1x2,1) LP-6240

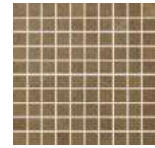

MOSAIC LEX RUST
22,5x22,5 (2,1x2,1) LP-6240

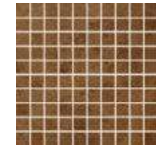

MOSAIC LEX CORTEN
22,5x22,5 (2,1x2,1) LP-6240

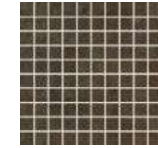

MOSAIC LEX CARBON
22,5x22,5 (2,1x2,1) LP-6240

8 mm

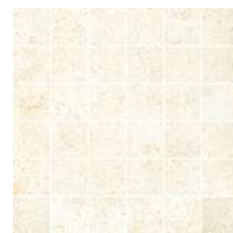

MOSAIC PLUS PLATINUM
35x35 (5,7x5,7) LP-6300



MOSAIC PLUS STEEL
35x35 (5,7x5,7) LP-6300



MOSAIC PLUS RUST
35x35 (5,7x5,7) LP-6300



MOSAIC PLUS CARBON
35x35 (5,7x5,7) LP-6300



MOSAIC ARROW PLATINUM
35x35 LP-6330



MOSAIC ARROW STEEL
35x35 LP-6330



MOSAIC ARROW RUST
35x35 LP-6330



MOSAIC ARROW CARBON
35x35 LP-6330

Metallic

Collection



8 mm



MOSAIC METALIC PLATINUM
35x35 (4,2x4,2) LP-6310



MOSAIC METALIC STEEL
35x35 (4,2x4,2) LP-6310



MOSAIC METALIC IRON
35x35 (4,2x4,2) LP-6310



MOSAIC METALIC RUST
35x35 (4,2x4,2) LP-6310



MOSAIC METALIC CORTEN
35x35 (4,2x4,2) LP-6310

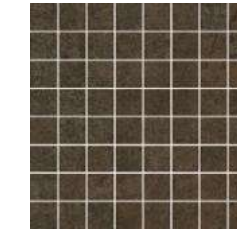

MOSAIC METALIC CARBON
35x35 (4,2x4,2) LP-6310



MOSAIC PRISM PLATINUM
35x35 LP-6380



MOSAIC PRISM STEEL
35x35 LP-6380



MOSAIC PRISM IRON
35x35 LP-6380



MOSAIC PRISM RUST
35x35 LP-6380



MOSAIC PRISM CORTEN
35x35 LP-6380



MOSAIC PRISM CARBON
35x35 LP-6380

Index

Colour Map

Collections

- Arise
- Avenue
- Balance
- Canyon
- Core
- Genesis
- Gravity
- Ground
- Light
- Marble
- Mémorable
- Metallic**
- Native
- Nest
- Precious
- Pulse
- Sense
- Splash
- Timber
- Urban
- Wooden

Technical Specifications



Listelo Brushed
Listelo Shine

LISTELO BRUSHED GOLD
0,5x1,1x100 **LP-6420**

LISTELO BRUSHED SILVER
0,5x1,1x100 **LP-6348**

✕ **LISTELO SHINE SILVER**
0,5x1,1x100 **LP-6348**

LISTELO BRUSHED BRONZE
0,5x1,1x100 **LP-6420**



Listelo Blink

LISTELO BLINK BRUSHED GOLD
0,5x1,2x120 **LP-6510**

LISTELO BLINK BRUSHED SILVER
0,5x1,2x120 **LP-6510**

LISTELO BLINK BRUSHED BRONZE
0,5x1,2x120 **LP-6510**



8 mm →



MOSAIC COVER PLATINUM
30x30 (4,8x4,8) **LP-6190**



MOSAIC COVER STEEL
30x30 (4,8x4,8) **LP-6190**



MOSAIC COVER IRON
30x30 (4,8x4,8) **LP-6190**



MOSAIC COVER RUST
30x30 (4,8x4,8) **LP-6190**



MOSAIC COVER CORTEN
30x30 (4,8x4,8) **LP-6190**



MOSAIC COVER CARBON
30x30 (4,8x4,8) **LP-6190**

- Arise
- Avenue
- Balance
- Canyon
- Core
- Genesis
- Gravity
- Ground
- Light
- Marble
- Mémorable
- Metallic**
- Native
- Nest
- Precious
- Pulse
- Sense
- Splash
- Timber
- Urban
- Wooden





Sublime Calacatta Gold 45 x 119 Ret. Precious Calacatta Gold 45 x 119 Ret. Precious Calacatta Gold Pol. 79 x 79 Ret.

Precious

Collection

DOWNLOAD CATALOGUE  VIEW ONLINE 



45 x 119  9,5 mm
35 x 70 · 35 x 100  8 mm



60 x 60 · 80 x 80  9 mm



Index ▾

Colour Map ▾

Collections ▾

- Arise
- Avenue
- Balance
- Canyon
- Core
- Genesis
- Gravity
- Ground
- Light
- Marble
- Mémorable
- Metallic
- Native
- Nest
- Precious**
- Pulse
- Sense
- Splash
- Timber
- Urban
- Wooden

Technical Specifications ▾

Precious

Collection



Precious

Collection



Index ▼

Colour Map ▼

Collections ▼

- Arise
- Avenue
- Balance
- Canyon
- Core
- Genesis
- Gravity
- Ground
- Light
- Marble
- Mémorable
- Metallic
- Native
- Nest
- Precious**
- Pulse
- Sense
- Splash
- Timber
- Urban
- Wooden

Technical Specifications ▼



- Arise
- Avenue
- Balance
- Canyon
- Core
- Genesis
- Gravity
- Ground
- Light
- Marble
- Mémorable
- Metallic
- Native
- Nest
- Precious**
- Pulse
- Sense
- Splash
- Timber
- Urban
- Wooden

Precious

Collection

Precious

Collection



Index ▼

Colour Map ▼

Collections ▼

- Arise
- Avenue
- Balance
- Canyon
- Core
- Genesis
- Gravity
- Ground
- Light
- Marble
- Mémorable
- Metallic
- Native
- Nest
- Precious**
- Pulse
- Sense
- Splash
- Timber
- Urban
- Wooden

Technical Specifications ▼

LOVE
CERAMIC TILES

Precious Calacatta
35 x 100 Ret.

Precious Calacatta Matt
60 x 60 Ret.

Precious

Collection



Precious

Collection

Index ▼

Colour Map ▼

Collections ▼

- Arise
- Avenue
- Balance
- Canyon
- Core
- Genesis
- Gravity
- Ground
- Light
- Marble
- Mémorable
- Metallic
- Native
- Nest
- Precious**
- Pulse
- Sense
- Splash
- Timber
- Urban
- Wooden

Technical Specifications ▼

LOVE
CERAMIC TILES

Precious Calacatta Matt
35 x 70 Ret.

Mosaic Precious Mix Calacatta
35 x 35

Precious Calacatta Matt
60 x 60 Ret.



45x119 · 9,5 mm



× **PRECIOUS CALACATTA GOLD**
45x119 Ret. **LT-8695**

9,8 - 11,6 mm



× **PRECIOUS FLUX CALACATTA GOLD**
45x119 Ret. **LT-8930**



× **SUBLIME CALACATTA GOLD**
45x119 Ret. **LP-6650**

7,5 - 8,9 mm



× **PRECIOUS CURL CALACATTA GOLD**
35x70 Ret. **LT-7700**



PRECIOUS CURL CALACATTA GOLD MATT
35x70 Ret. **LT-7700**



× **PERFIL PRECIOUS CALACATTA GOLD**
1,3x45 **LP-6310**
1,3x35 **LP-6220**
PERFIL PRECIOUS CALACATTA GOLD MATT
1,3x35 **LP-6220**



35x100 · 35x70 · 8 mm



PRECIOUS CALACATTA GOLD ×
35x100 Ret. **LT-8095**
35x70 Ret. **LT-7440**



PRECIOUS CALACATTA GOLD MATT
35x100 Ret. **LT-8095**
35x70 Ret. **LT-7440**



PRECIOUS SHAPE CALACATTA GOLD ×
35x100 Ret. **LT-8270**

8,9 - 10,5 mm



PRECIOUS SHAPE CALACATTA GOLD MATT
35x100 Ret. **LT-8270**

8,8 - 10,5 mm



RISE CALACATTA GOLD MATT
35x100 Ret. **LT-8270**

8 mm



× **MOSAIC ENIGMA CALACATTA GOLD**
35x35 **LP-6450**



MOSAIC ENIGMA CALACATTA GOLD MATT
35x35 **LP-6450**

- Arise
- Avenue
- Balance
- Canyon
- Core
- Genesis
- Gravity
- Ground
- Light
- Marble
- Mémorable
- Metallic
- Native
- Nest
- Precious**
- Pulse
- Sense
- Splash
- Timber
- Urban
- Wooden

Precious

Collection



9,5 mm



× **PRECIOUS CALACATTA**
45x119 Ret. **LT-8695**

9,8 - 11,6 mm



× **PRECIOUS FLUX CALACATTA**
45x119 Ret. **LT-8930**

35x100 - 35x70 - 8 mm



× **PRECIOUS CALACATTA**
35x100 Ret. **LT-8095**
35x70 Ret. **LT-7440**

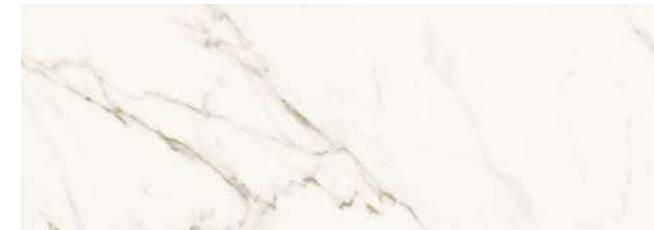

PRECIOUS CALACATTA MATT
35x100 Ret. **LT-8095**
35x70 Ret. **LT-7440**

8,9 - 10,5 mm



× **PRECIOUS SHAPE CALACATTA**
35x100 Ret. **LT-8270**



PRECIOUS SHAPE CALACATTA MATT
35x100 Ret. **LT-8270**



× **PERFIL PRECIOUS CALACATTA**
1,3x45 **LP-6310**
1,3x35 **LP-6220**
PERFIL PRECIOUS CALACATTA MATT
1,3x35 **LP-6220**

Precious

Collection



9 - 9,3 mm



FLOW CALACATTA ×
35x100 Ret. **LT-8270**



FLOW CALACATTA MATT
35x100 Ret. **LT-8270**

35x100 - 8 mm



SUPERB CALACATTA ×
35x100 Ret. **LP-6480**



SUPERB CALACATTA MATT
35x100 Ret. **LP-6480**



BELOVED CALACATTA ×
35x100 Ret. **LT-8270**



GORGEOUS CALACATTA ×
35x100 Ret. **LP-6460**

Collections ▾

- Arise
- Avenue
- Balance
- Canyon
- Core
- Genesis
- Gravity
- Ground
- Light
- Marble
- Mémorable
- Metallic
- Native
- Nest
- Precious**
- Pulse
- Sense
- Splash
- Timber
- Urban
- Wooden



7,5 - 8,9 mm



PRECIOUS CURL CALACATTA
35x70 Ret. LT-7700



PRECIOUS CURL CALACATTA MATT
35x70 Ret. LT-7700

8 mm



TENDER CALACATTA
35x70 Ret. LP-6450



TENDER CALACATTA MATT
35x70 Ret. LP-6450



SUPERB CALACATTA
35x70 Ret. LP-6450



SUPERB CALACATTA MATT
35x70 Ret. LP-6450



8 mm



MOSAIC HEXAGON MIX CALACATTA *
31x31 LP-6370



MOSAIC PRECIOUS MIX CALACATTA *
35x35 LP-6348

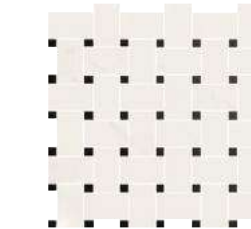

MOSAIC PRECIOUS TIE CALACATTA
35x35 LP-6370

*
Mosaico com mistura de peças brilho e mate
Mosaic mixing glossy and matt pieces
Mosaïque avec mélange de pièces finitions brillant et mat
Mosaik mit einer Mischung von glänzende und matt Elemente
Мозаика с миксом глянцевых и матовых чипсов
Mosaico con pezzi misti lucidi e opachi

PEÇAS ESPECIAIS | SPECIAL PIECES | PIÈCES SPÉCIALES | SPEZIALTEILE | СПЕЦИАЛЬНЫЕ ИЗДЕЛИЯ | PEZZI SPECIALI

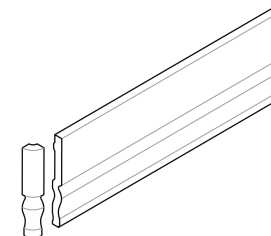

ALZATA PRECIOUS CALACATTA
12,5x35 STOCK OFF LP-6340
ANGOLO ALZATA PRECIOUS CALACATTA
12,5x2 STOCK OFF LP-6330

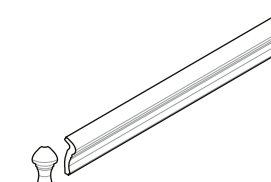

TORELLO PRECIOUS SHINE
5x35 LP-6270
ANGOLO TORELLO PRECIOUS SHINE
5x2 STOCK OFF LP-6260

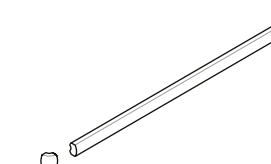

MATITA PRECIOUS SHINE
1,5x35 STOCK OFF LP-6220
ANGOLO MATITA PRECIOUS SHINE
1,5x1,5 STOCK OFF LP-6260



Listelo Brushed
Listelo Shine

LISTELO BRUSHED GOLD

0,5x1,1x100 **LP-6420**
0,5x1,1x70 **LP-6370**

LISTELO BRUSHED SILVER

0,5x1,1x100 **LP-6348**
0,5x1,1x70 **LP-6310**

✕ **LISTELO SHINE SILVER**

0,5x1,1x100 **LP-6348**
0,5x1,1x70 **LP-6310**

LISTELO BRUSHED BRONZE

0,5x1,1x100 **LP-6420**
0,5x1,1x70 **LP-6370**



Listelo Blink

LISTELO BLINK BRUSHED GOLD

0,5x1,2x120 **LP-6510**

LISTELO BLINK BRUSHED SILVER

0,5x1,2x120 **LP-6510**

LISTELO BLINK BRUSHED BRONZE

0,5x1,2x120 **LP-6510**



9 mm



PRECIOUS CALACATTA GOLD POL. ✕

79x79 Ret. **LT-3190**
60x60 Ret. **LT-2670**



PRECIOUS CALACATTA GOLD MATT

80x80 Ret. **LT-2870**
60x60 Ret. **LT-2440**

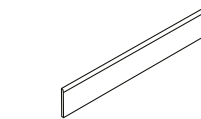

✕ **RODAPÉ PRECIOUS CALACATTA GOLD POL.**

8x79 Ret. **LP-6135**
8x60 Ret. **LP-6085**

RODAPÉ PRECIOUS CALACATTA GOLD MATT

8x80 Ret. **LP-6130**
8x60 Ret. **LP-6075**



PRECIOUS CALACATTA POL. ✕

79x79 Ret. **LT-3190**
60x60 Ret. **LT-2670**



PRECIOUS CALACATTA MATT

80x80 Ret. **LT-2870**
60x60 Ret. **LT-2440**

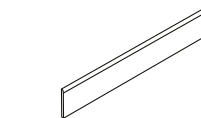

✕ **RODAPÉ PRECIOUS CALACATTA POL.**

8x79 Ret. **LP-6135**
8x60 Ret. **LP-6085**

RODAPÉ PRECIOUS CALACATTA MATT

8x80 Ret. **LP-6130**
8x60 Ret. **LP-6075**

Os produtos com acabamento polido são mais sensíveis à abrasão e às manchas. Por favor consulte a página 392 no capítulo 09.
Products with a polished finish are more sensitive to abrasion and stains. Please see page 392 in chapter 09.
Les produits à finition polie sont plus sensibles à l'abrasion et aux taches. Veuillez-vous consulter la page 392 du chapitre 09.
Produkte mit einer polierten Oberfläche sind empfindlicher gegen Abrieb und Fleckenbildung. Bitte beachten Sie Seite 392 in Kapitel 09.
Изделия с полированной поверхностью наиболее подвержены к истиранию и появлению пятен. Пожалуйста, посмотрите информацию на странице 392, в главе 09.
I prodotti con finitura lucida sono più sensibili all'abrasione e alle macchie. Si prega di fare riferimento alla pagina 392 del capitolo 09.

- Arise
- Avenue
- Balance
- Canyon
- Core
- Genesis
- Gravity
- Ground
- Light
- Marble
- Mémorable
- Metallic
- Native
- Nest
- Precious**
- Pulse
- Sense
- Splash
- Timber
- Urban
- Wooden





Marble Beige Shine 45 x 119 Ret. Marble Flux Beige Shine 45 x 119 Ret. Marble Beige Matt 60 x 60 Ret.

Marble

Collection

DOWNLOAD CATALOGUE  VIEW ONLINE 



45 x 119  9,5 mm
35 x 70 · 35 x 100  8 mm

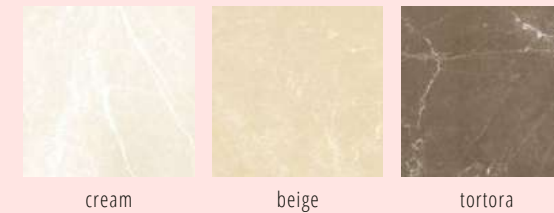
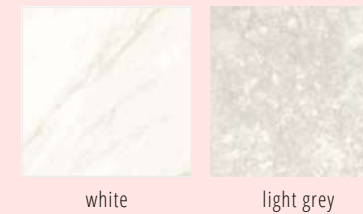

60 x 60 · 80 x 80  9 mm

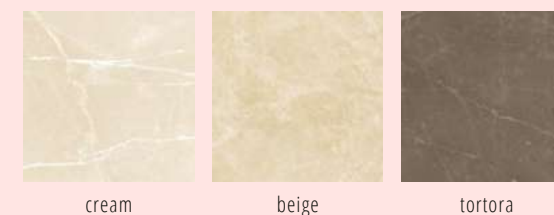

Index ▾

Colour Map ▾

Collections ▾

- Arise
- Avenue
- Balance
- Canyon
- Core
- Genesis
- Gravity
- Ground
- Light
- Marble**
- Mémorable
- Metallic
- Native
- Nest
- Precious
- Pulse
- Sense
- Splash
- Timber
- Urban
- Wooden

Technical Specifications ▾

Marble

Collection



Marble

Collection



Index ▾

Colour Map ▾

Collections ▾

- Arise
- Avenue
- Balance
- Canyon
- Core
- Genesis
- Gravity
- Ground
- Light
- Marble**
- Mémorable
- Metallic
- Native
- Nest
- Precious
- Pulse
- Sense
- Splash
- Timber
- Urban
- Wooden

LOVE
CERAMIC TILES

Marble Light Grey Matt
35 x 100 Ret.

Marble Light Grey Matt
60 x 60 Ret.

Technical Specifications ▾

Marble

Collection



Marble

Collection

Index ▾

Colour Map ▾

Collections ▾

- Arise
- Avenue
- Balance
- Canyon
- Core
- Genesis
- Gravity
- Ground
- Light
- Marble**
- Mémorable
- Metallic
- Native
- Nest
- Precious
- Pulse
- Sense
- Splash
- Timber
- Urban
- Wooden

LOVE
CERAMIC TILES

Marble Tortora Shine
35 x 100 Ret.

Marble Cream Shine
35 x 100 Ret.

Mosaic Marble Tortora Shine
17,5 x 17,5

Mosaic Marble Cream Shine
17,5 x 17,5

Marble Cream Pol.
60 x 60 Ret.

Technical Specifications ▾

Marble

Collection



Marble

Collection



Index ▾

Colour Map ▾

Collections ▾

- Arise
- Avenue
- Balance
- Canyon
- Core
- Genesis
- Gravity
- Ground
- Light
- Marble**
- Mémorable
- Metallic
- Native
- Nest
- Precious
- Pulse
- Sense
- Splash
- Timber
- Urban
- Wooden

Technical Specifications ▾

Marble

Collection



Marble

Collection

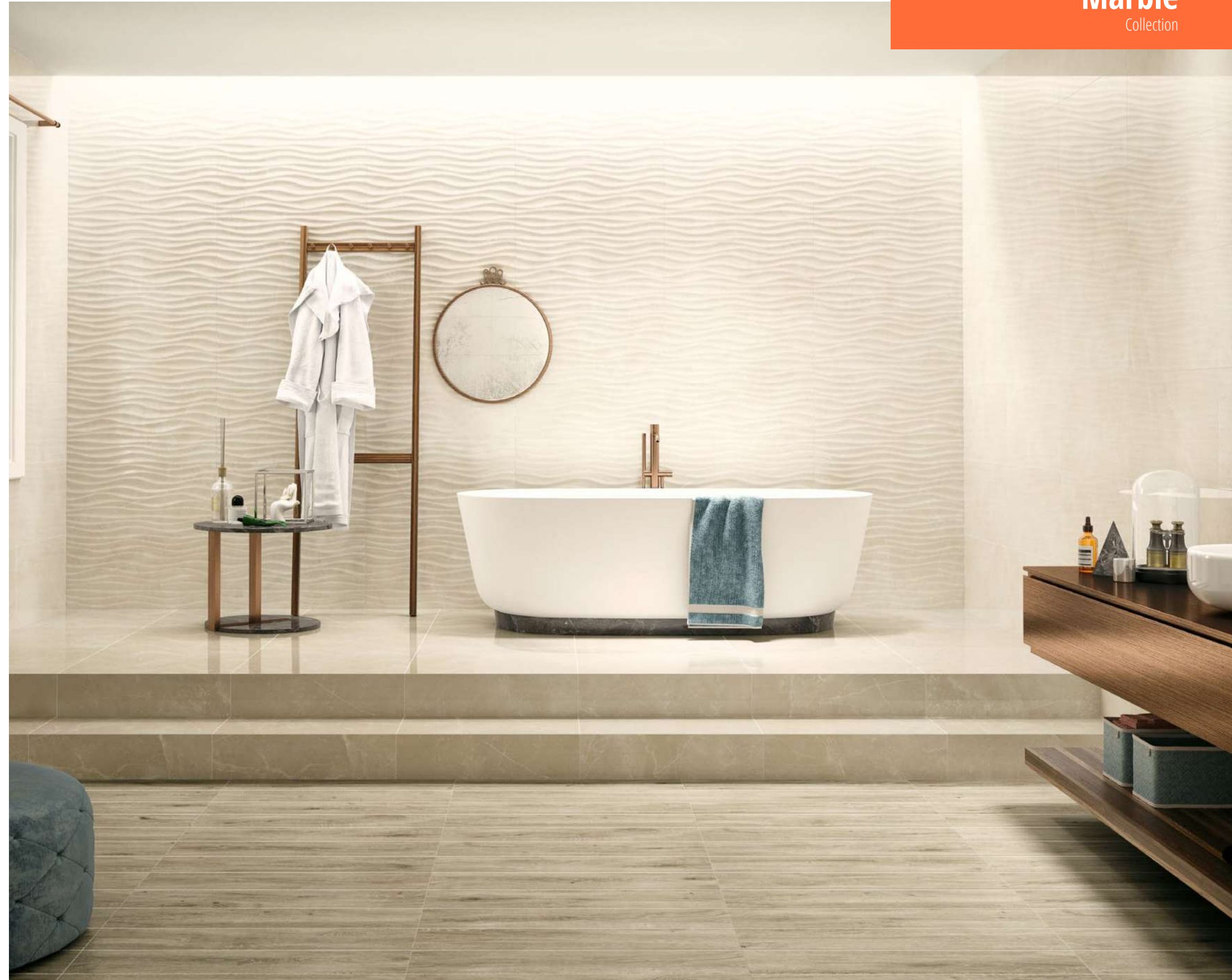

Index ▼

Colour Map ▼

Collections ▼

- Arise
- Avenue
- Balance
- Canyon
- Core
- Genesis
- Gravity
- Ground
- Light
- Marble**
- Mémorable
- Metallic
- Native
- Nest
- Precious
- Pulse
- Sense
- Splash
- Timber
- Urban
- Wooden

Technical Specifications ▼

LOVE
CERAMIC TILES

Marble Cream Shine
35 x 70 Ret.

Marble Curl Cream Shine
35 x 70 Ret.

Marble Cream Pol.
60 x 60 Ret.

Marble

Collection



Marble Beige Pol.
79 x 79 Ret.



Marble

Collection

Index ▾

Colour Map ▾

Collections ▾

- Arise
- Avenue
- Balance
- Canyon
- Core
- Genesis
- Gravity
- Ground
- Light
- Marble**
- Mémorable
- Metallic
- Native
- Nest
- Precious
- Pulse
- Sense
- Splash
- Timber
- Urban
- Wooden

Technical Specifications ▾

Marble

Collection



45x119 · 45x45 · 9,5 mm



✕ **MARBLE WHITE SHINE**
45x119 RET. **LT-8695**

FLUX · 9,8 – 11,6 mm



✕ **MARBLE FLUX WHITE SHINE**
45x119 RET. **LT-8930**



✕ **TWIST WHITE SHINE**
45x119 RET. **LP-6540**



✕ **MOSAIC SPARKLE WHITE**
45x45 **LP-6410**

35x70 · 8 mm



✕ **MARBLE WHITE SHINE**
35x70 RET. **LT-7440**
MARBLE WHITE MATT
35x70 RET. **LT-7440**

CURL · 7,5 – 8,9 mm



✕ **MARBLE CURL WHITE SHINE**
35x70 RET. **LT-7700**
MARBLE CURL WHITE MATT
35x70 RET. **LT-7700**



✕ **BLISS WHITE SHINE**
35x70 RET. **LP-6440**

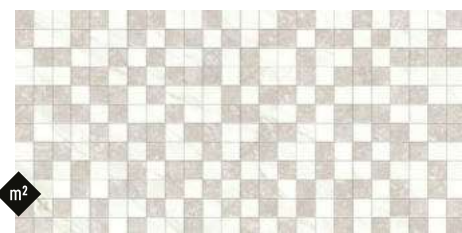

✕ **HAPPY WHITE**
35x70 RET. **LT-7700**

Marble

Collection



35x100 · 8 mm

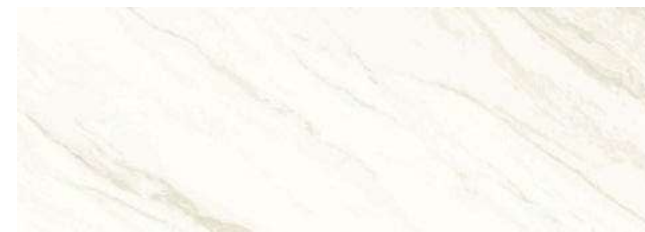

✕ **MARBLE WHITE SHINE**
35x100 RET. **LT-8095**
MARBLE WHITE MATT
35x100 RET. **LT-8095**

SHAPE · 8,9 – 10,5 mm



✕ **MARBLE SHAPE WHITE SHINE**
35x100 RET. **LT-8270**
MARBLE SHAPE WHITE MATT
35x100 RET. **LT-8270**



✕ **LAYERS WHITE MATT**
35x100 RET. **LP-6480**



✕ **GLEE WHITE SHINE**
35x100 RET. **LP-6530**



8 mm



✕ **MOSAIC MARBLE WHITE SHINE**
17,5x17,5 (2x2) **LP-6160**



✕ **MOSAIC MARBLE WHITE MATT**
17,5x17,5 (2x2) **LP-6160**



✕ **MOSAIC GLEAM WHITE SHINE**
17,5x17,5 (2x2) **LP-6160**



✕ **MOSAIC WHITE LIGHT GREY SHINE**
17,5x17,5 (2x2) **LP-6190**

Collections ▾

- Arise
- Avenue
- Balance
- Canyon
- Core
- Genesis
- Gravity
- Ground
- Light
- Marble**
- Mémorable
- Metallic
- Native
- Nest
- Precious
- Pulse
- Sense
- Splash
- Timber
- Urban
- Wooden

Marble

Collection



45x119 · 45x45 · 9,5 mm



× **MARBLE CREAM SHINE**
45x119 RET. LT-8695

FLUX · 9,8 – 11,6 mm



× **MARBLE FLUX CREAM SHINE**
45x119 RET. LT-8930



× **TWIST CREAM SHINE**
45x119 RET. LP-6540



× **MOSAIC SPARKLE CREAM**
45x45 LP-6410

35x70 · 8 mm



× **MARBLE CREAM SHINE**
35x70 RET. LT-7440
MARBLE CREAM MATT
35x70 RET. LT-7440

CURL · 7,5 – 8,9 mm

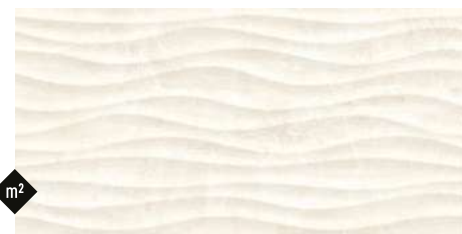

× **MARBLE CURL CREAM SHINE**
35x70 RET. LT-7700
MARBLE CURL CREAM MATT
35x70 RET. LT-7700

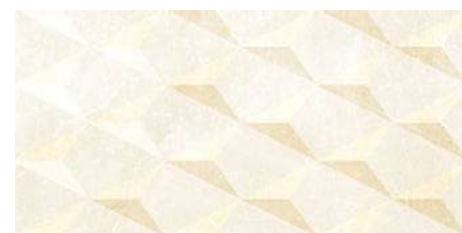

× **BLISS CREAM SHINE**
35x70 RET. LP-6440

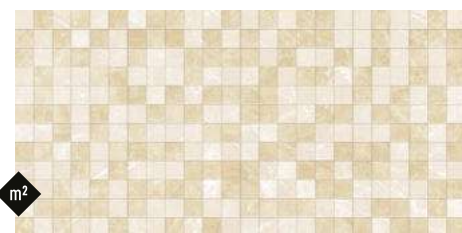

× **HAPPY CREAM**
35x70 RET. LT-7700

Marble

Collection



35x100 · 8 mm



× **MARBLE CREAM SHINE**
35x100 RET. LT-8095
MARBLE CREAM MATT
35x100 RET. LT-8095

SHAPE · 8,9 – 10,5 mm



× **MARBLE SHAPE CREAM SHINE**
35x100 RET. LT-8270
MARBLE SHAPE CREAM MATT
35x100 RET. LT-8270



LAYERS CREAM MATT
35x100 RET. LP-6480



× **GLEE CREAM SHINE**
35x100 RET. LP-6530



8 mm

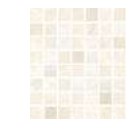

× **MOSAIC MARBLE CREAM SHINE**
17,5x17,5 (2x2) LP-6160

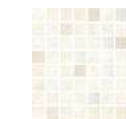

MOSAIC MARBLE CREAM MATT
17,5x17,5 (2x2) LP-6160

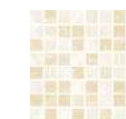

× **MOSAIC GLEAN CREAM SHINE**
17,5x17,5 (2x2) LP-6160



× **MOSAIC CREAM BEIGE SHINE**
17,5x17,5 (2x2) LP-6190

- Arise
- Avenue
- Balance
- Canyon
- Core
- Genesis
- Gravity
- Ground
- Light
- Marble**
- Mémorable
- Metallic
- Native
- Nest
- Precious
- Pulse
- Sense
- Splash
- Timber
- Urban
- Wooden

Marble

Collection



45x119 · 45x45 · 9,5 mm



× **MARBLE LIGHT GREY SHINE**
45x119 RET. **LT-8695**

FLUX · 9,8 – 11,6 mm



× **MARBLE FLUX LIGHT GREY SHINE**
45x119 RET. **LT-8930**



× **TWIST LIGHT GREY SHINE**
45x119 RET. **LP-6540**



× **MOSAIC SPARKLE WHITE**
45x45 **LP-6410**

35x70 · 8 mm



× **MARBLE LIGHT GREY SHINE**
35x70 RET. **LT-7440**
MARBLE LIGHT GREY MATT
35x70 RET. **LT-7440**

CURL · 7,5 – 8,9 mm



× **MARBLE CURL LIGHT GREY SHINE**
35x70 RET. **LT-7700**
MARBLE CURL LIGHT GREY MATT
35x70 RET. **LT-7700**



× **BLISS LIGHT GREY SHINE**
35x70 RET. **LP-6440**

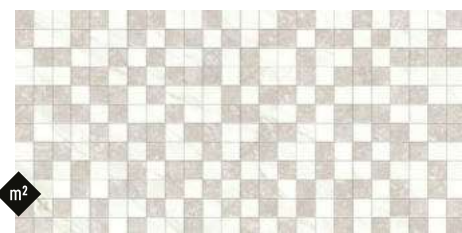

× **HAPPY WHITE**
35x70 RET. **LT-7700**

Marble

Collection



35x100 · 8 mm



× **MARBLE LIGHT GREY SHINE**
35x100 RET. **LT-8095**
MARBLE LIGHT GREY MATT
35x100 RET. **LT-8095**

SHAPE · 8,9 – 10,5 mm



× **MARBLE SHAPE LIGHT GREY SHINE**
35x100 RET. **LT-8270**
MARBLE SHAPE LIGHT GREY MATT
35x100 RET. **LT-8270**



× **GLEE LIGHT GREY SHINE**
35x100 RET. **LP-6530**



× **LAYERS LIGHT GREY MATT**
35x100 RET. **LP-6480**



8 mm

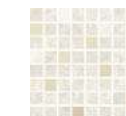

× **MOSAIC MARBLE LIGHT GREY SHINE**
17,5x17,5 (2x2) **LP-6160**



× **MOSAIC MARBLE LIGHT GREY MATT**
17,5x17,5 (2x2) **LP-6160**



× **MOSAIC GLEAM WHITE SHINE**
17,5x17,5 (2x2) **LP-6160**



× **MOSAIC WHITE LIGHT GREY SHINE**
17,5x17,5 (2x2) **LP-6190**

Collections ▾

- Arise
- Avenue
- Balance
- Canyon
- Core
- Genesis
- Gravity
- Ground
- Light
- Marble**
- Mémorable
- Metallic
- Native
- Nest
- Precious
- Pulse
- Sense
- Splash
- Timber
- Urban
- Wooden

Marble

Collection



45x119 · 9,5 mm



× **MARBLE BEIGE SHINE**
45x119 RET. **LT-8695**

FLUX · 9,8 – 11,6 mm



× **MARBLE FLUX BEIGE SHINE**
45x119 RET. **LT-8930**



× **TWIST BEIGE SHINE**
45x119 RET. **LP-6540**

35x70 · 8 mm

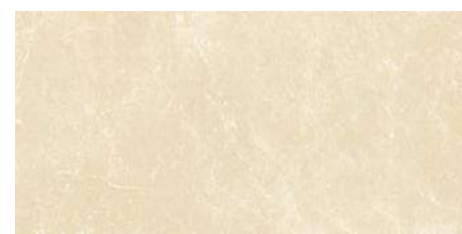

× **MARBLE BEIGE SHINE**
35x70 RET. **LT-7440**
MARBLE BEIGE MATT
35x70 RET. **LT-7440**

CURL · 7,5 – 8,9 mm



× **MARBLE CURL BEIGE SHINE**
35x70 RET. **LT-7700**
MARBLE CURL BEIGE MATT
35x70 RET. **LT-7700**



× **BLISS BEIGE SHINE**
35x70 RET. **LP-6440**

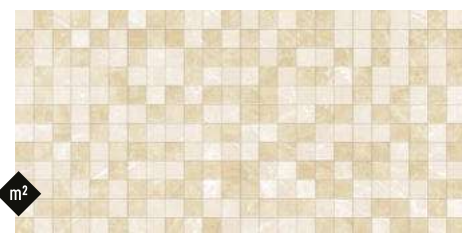

× **HAPPY CREAM**
35x70 RET. **LT-7700**

Marble

Collection



35x100 · 8 mm



× **MARBLE BEIGE SHINE**
35x100 RET. **LT-8095**
MARBLE BEIGE MATT
35x100 RET. **LT-8095**

SHAPE · 8,9 – 10,5 mm



× **MARBLE SHAPE BEIGE SHINE**
35x100 RET. **LT-8270**
MARBLE SHAPE BEIGE MATT
35x100 RET. **LT-8270**



× **GLEE BEIGE SHINE**
35x100 RET. **LP-6530**



LAYERS BEIGE MATT
35x100 RET. **LP-6480**



8 mm



× **MOSAIC MARBLE BEIGE SHINE**
17,5x17,5 (2x2) **LP-6160**



MOSAIC MARBLE BEIGE MATT
17,5x17,5 (2x2) **LP-6160**



× **MOSAIC GLEAM CREAM SHINE**
17,5x17,5 (2x2) **LP-6160**



× **MOSAIC CREAM BEIGE SHINE**
17,5x17,5 (2x2) **LP-6190**

Collections ▾

- Arise
- Avenue
- Balance
- Canyon
- Core
- Genesis
- Gravity
- Ground
- Light
- Marble**
- Mémorable
- Metallic
- Native
- Nest
- Precious
- Pulse
- Sense
- Splash
- Timber
- Urban
- Wooden

Marble

Collection



45x119 - 45x45 - 9,5 mm



× **MARBLE TORTORA SHINE**
45x119 RET. LT-8695

FLUX - 9,8 - 11,6 mm



× **MARBLE FLUX TORTORA SHINE**
45x119 RET. LT-8930



× **TWIST TORTORA SHINE**
45x119 RET. LP-6540



× **MOSAIC SPARKLE CREAM**
45x45 LP-6410

35x70 - 8 mm



× **MARBLE TORTORA SHINE**
35x70 RET. LT-7440
MARBLE TORTORA MATT
35x70 RET. LT-7440

CURL - 7,5 - 8,9 mm



× **MARBLE CURL TORTORA SHINE**
35x70 RET. LT-7700
MARBLE CURL TORTORA MATT
35x70 RET. LT-7700



× **BLISS TORTORA SHINE**
35x70 RET. LP-6440

Marble

Collection



35x100 - 8 mm



× **MARBLE TORTORA SHINE**
35x100 RET. LT-8095
MARBLE TORTORA MATT
35x100 RET. LT-8095

SHAPE - 8,9 - 10,5 mm



× **MARBLE SHAPE TORTORA SHINE**
35x100 RET. LT-8270
MARBLE SHAPE TORTORA MATT
35x100 RET. LT-8270



× **GLEE TORTORA SHINE**
35x100 RET. LP-6530



LAYERS TORTORA MATT
35x100 RET. LP-6480



× **MOSAIC MARBLE TORTORA SHINE**
17,5x17,5 (2x2) LP-6160

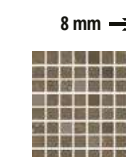

MOSAIC MARBLE TORTORA MATT
17,5x17,5 (2x2) LP-6160

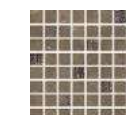

× **MOSAIC TORTORA SHINE**
17,5x17,5 (2x2) LP-6190

Collections ▾

- Arise
- Avenue
- Balance
- Canyon
- Core
- Genesis
- Gravity
- Ground
- Light
- Marble**
- Mémorable
- Metallic
- Native
- Nest
- Precious
- Pulse
- Sense
- Splash
- Timber
- Urban
- Wooden



Listelo Brushed
Listelo Shine

LISTELO BRUSHED GOLD

0,5x1,1x100 **LP-6420**
0,5x1,1x70 **LP-6370**

LISTELO BRUSHED SILVER

0,5x1,1x100 **LP-6348**
0,5x1,1x70 **LP-6310**

✕ LISTELO SHINE SILVER

0,5x1,1x100 **LP-6348**
0,5x1,1x70 **LP-6310**

LISTELO BRUSHED BRONZE

0,5x1,1x100 **LP-6420**
0,5x1,1x70 **LP-6370**



Listelo Blink

LISTELO BLINK BRUSHED GOLD

0,5x1,2x120 **LP-6510**

LISTELO BLINK BRUSHED SILVER

0,5x1,2x120 **LP-6510**

LISTELO BLINK BRUSHED BRONZE

0,5x1,2x120 **LP-6510**

PEÇAS ESPECIAIS | SPECIAL PIECES | PIÈCES SPÉCIALES | SPEZIALTEILE | СПЕЦИАЛЬНЫЕ ИЗДЕЛИЯ | PEZZI SPECIALI

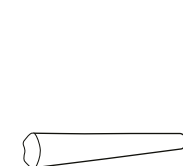

✕ PERFIL MARBLE SHINE

1,3x45 **LP-6310**
1,3x35 **LP-6220**

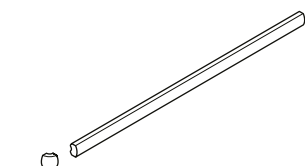

✕ MATITA MARBLE SHINE

1,5x45 **STOCK OFF LP-6270**
1,5x35 **STOCK OFF LP-6220**

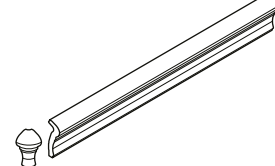

✕ TORELLO MARBLE SHINE

5x45 **STOCK OFF LP-6310**
5x35 **LP-6270**

PERFIL MARBLE MATT

1,3x35 **LP-6220**

✕ ANGOLO MATITA MARBLE SHINE

1,5x1,5 **STOCK OFF LP-6260**

✕ ANGOLO TORELLO MARBLE SHINE

5x2 **STOCK OFF LP-6260**

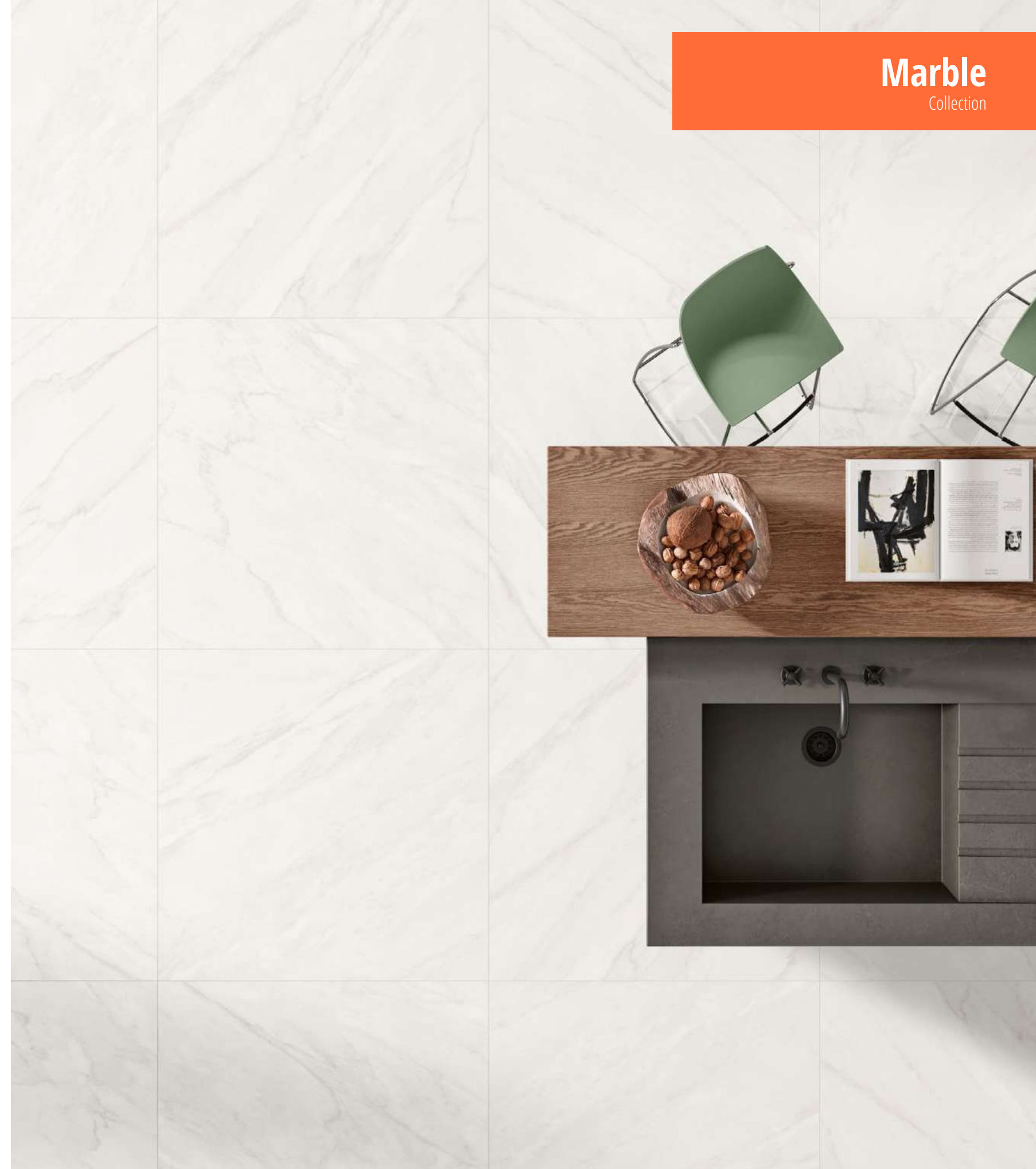

Marble White Pol.
79 x 79 Ret.

- Arise
- Avenue
- Balance
- Canyon
- Core
- Genesis
- Gravity
- Ground
- Light
- Marble**
- Mémorable
- Metallic
- Native
- Nest
- Precious
- Pulse
- Sense
- Splash
- Timber
- Urban
- Wooden



9 mm



✕ **MARBLE WHITE POL.**
79x79 Ret. **LT-3190**
60x60 Ret. **LT-2670**



MARBLE WHITE MATT
80x80 Ret. **LT-2870**
60x60 Ret. **LT-2440**



✕ **MARBLE CREAM POL.**
79x79 Ret. **LT-3190**
60x60 Ret. **LT-2670**



MARBLE CREAM MATT
80x80 Ret. **LT-2870**
60x60 Ret. **LT-2440**



✕ **MARBLE LIGHT GREY POL.**
60x60 Ret. **LT-2670**



MARBLE LIGHT GREY MATT
60x60 Ret. **LT-2440**



✕ **MARBLE BEIGE POL.**
79x79 Ret. **LT-3190**
60x60 Ret. **LT-2670**



MARBLE BEIGE MATT
80x80 Ret. **LT-2870**
60x60 Ret. **LT-2440**

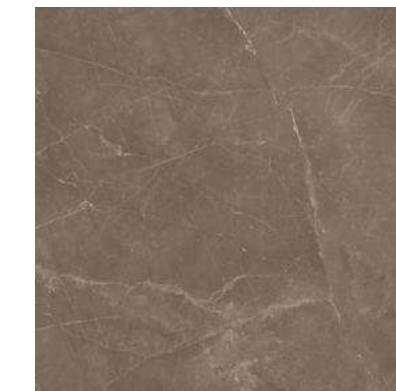

✕ **MARBLE TORTORA POL.**
60x60 Ret. **LT-2670**



MARBLE TORTORA MATT
60x60 Ret. **LT-2440**

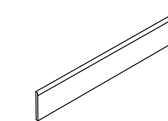

✕ **RODAPÉ MARBLE POL.**
8x79 Ret. **LP-6135**
8x60 Ret. **LP-6085**
RODAPÉ MARBLE MATT
8x80 Ret. **LP-6130**
8x60 Ret. **LP-6075**

Os produtos com acabamento polido são mais sensíveis à abrasão e às manchas. Por favor consulte a página 392 no capítulo 09.
Products with a polished finish are more sensitive to abrasion and stains. Please see page 392 in chapter 09.
Les produits à finition polie sont plus sensibles à l'abrasion et aux taches. Veuillez-vous consulter la page 392 du chapitre 09.
Produkte mit einer polierten Oberfläche sind empfindlicher gegen Abrieb und Fleckenbildung. Bitte beachten Sie Seite 392 in Kapitel 09.
Изделия с полированной поверхностью наиболее подвержены к истиранию и появлению пятен. Пожалуйста, посмотрите информацию на странице 392, в главе 09.
I prodotti con finitura lucida sono più sensibili all'abrasione e alle macchie. Si prega di fare riferimento alla pagina 392 del capitolo 09.



9 mm

- Arise
- Avenue
- Balance
- Canyon
- Core
- Genesis
- Gravity
- Ground
- Light
- Marble**
- Mémorable
- Metallic
- Native
- Nest
- Precious
- Pulse
- Sense
- Splash
- Timber
- Urban
- Wooden





Nest Beige 35 x 100 Ret. Restful Nest Beige 35 x 100 Ret. Nest Beige 60 x 60 Ret.

Nest

Collection

DOWNLOAD CATALOGUE  VIEW ONLINE 



35 x 100  8 mm
30 x 60  7 mm

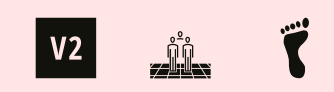
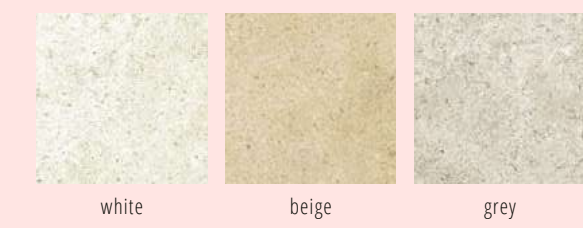

31 x 61 · 60 x 60  8 mm

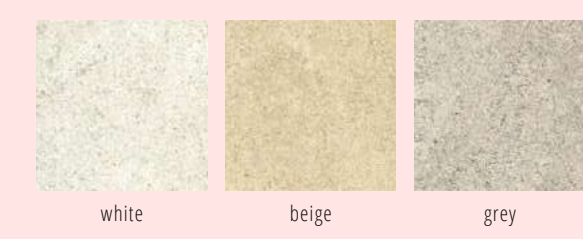

Index ▾

Colour Map ▾

Collections ▾

- Arise
- Avenue
- Balance
- Canyon
- Core
- Genesis
- Gravity
- Ground
- Light
- Marble
- Mémorable
- Metallic
- Native
- Nest**
- Precious
- Pulse
- Sense
- Splash
- Timber
- Urban
- Wooden

Technical Specifications ▾

Nest
Collection



Nest
Collection



Index ▾

Colour Map ▾

Collections ▾

- Arise
- Avenue
- Balance
- Canyon
- Core
- Genesis
- Gravity
- Ground
- Light
- Marble
- Mémorable
- Metallic
- Native
- Nest**
- Precious
- Pulse
- Sense
- Splash
- Timber
- Urban
- Wooden

Technical Specifications ▾

LOVE
CERAMIC TILES

Nest Grey
35 x 100 Ret.

Comfy Nest Grey
35 x 100 Ret.

Nest Grey
60 x 60 Ret.



Collections ▾

- Arise
- Avenue
- Balance
- Canyon
- Core
- Genesis
- Gravity
- Ground
- Light
- Marble
- Mémorable
- Metallic
- Native
- Nest**
- Precious
- Pulse
- Sense
- Splash
- Timber
- Urban
- Wooden



← 35x100 · 8 mm | 31x62 · 30x60 · 7 mm →



NEST WHITE
35x100 Ret. **LT-8095**
31x62 **LT-6190**
30x60 Ret. **LT-6800**

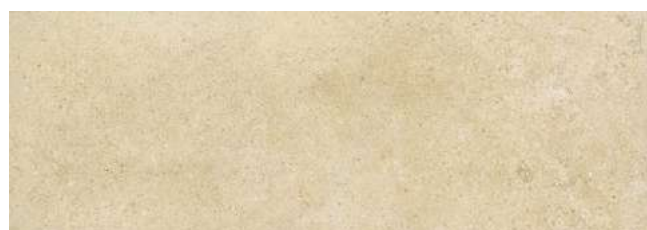

NEST BEIGE
35x100 Ret. **LT-8095**
31x62 **LT-6190**
30x60 Ret. **LT-6800**



NEST GREY
35x100 Ret. **LT-8095**
31x62 **LT-6190**
30x60 Ret. **LT-6800**

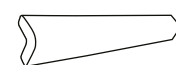

PERFIL NEST
1,7x35 **STOCK OFF** LP-6220



61x61 · 60x60 · 31x61 · 8 mm →



NEST WHITE
61x61 **LT-2160**
60x60 Ret. **LT-2440**
31x61 **LT-1510**



NEST BEIGE
61x61 **LT-2160**
60x60 Ret. **LT-2440**
31x61 **LT-1510**



NEST GREY
61x61 **LT-2160**
60x60 Ret. **LT-2440**
31x61 **LT-1510**

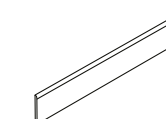

RODAPÉ NEST
8x61 **LP-6075**
8x60 Ret. **LP-6075**

- Arise
- Avenue
- Balance
- Canyon
- Core
- Genesis
- Gravity
- Ground
- Light
- Marble
- Mémorable
- Metallic
- Native
- Nest**
- Precious
- Pulse
- Sense
- Splash
- Timber
- Urban
- Wooden

Nest
Collection



35x100 • 9 – 9,2 mm | 31x62 • 30x60 • 7,5 – 7,7 mm



COMFY NEST WHITE
35x100 Ret. **LT-8270**
31x62 **LT-6490**
30x60 Ret. **LT-7095**

8,2 – 9,0 mm



RESTFUL NEST WHITE
35x100 ret. **LT-8270**



Nest
Collection



35x100 • 8 mm



CARE WHITE
35x100 Ret. **LT-8270**

31x62 • 30x60 • 7 mm



COZY WHITE
31x62 **LT-6490**
30x60 Ret. **LT-7095**



COMFY NEST BEIGE
35x100 Ret. **LT-8270**
31x62 **LT-6490**
30x60 Ret. **LT-7095**



RESTFUL NEST BEIGE
35x100 Ret. **LT-8270**



CARE BEIGE
35x100 Ret. **LT-8270**



COZY BEIGE
31x62 **LT-6490**
30x60 Ret. **LT-7095**



COMFY NEST GREY
35x100 Ret. **LT-8270**
31x62 **LT-6490**
30x60 Ret. **LT-7095**



RESTFUL NEST GREY
35x100 Ret. **LT-8270**



CARE GREY
35x100 Ret. **LT-8270**



COZY GREY
31x62 **LT-6490**
30x60 Ret. **LT-7095**

Index ▾

Colour Map ▾

Collections ▾

- Arise
- Avenue
- Balance
- Canyon
- Core
- Genesis
- Gravity
- Ground
- Light
- Marble
- Mémorable
- Metallic
- Native
- Nest**
- Precious
- Pulse
- Sense
- Splash
- Timber
- Urban
- Wooden

Technical Specifications ▾



8 mm



MOSAIC SHELTER WHITE
35x35 (1,9x1,9) LP-6410



MOSAIC SHELTER BEIGE
35x35 (1,9x1,9) LP-6410

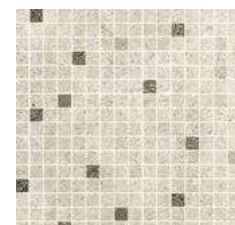

MOSAIC SHELTER GREY
35x35 (1,9x1,9) LP-6410



BRICK NEST WHITE
8,5x35 LP-6200



BRICK NEST BEIGE
8,5x35 LP-6200



BRICK NEST GREY
8,5x35 LP-6200



MOSAIC NEST WHITE
29,5x29,5 (3,1x3,1) LP-6220



MOSAIC NEST BEIGE
29,5x29,5 (3,1x3,1) LP-6220



MOSAIC NEST GREY
29,5x29,5 (3,1x3,1) LP-6220



8,5 mm

7 mm



LISTELO SNUG WHITE
6,5x62 **STOCK OFF** LP-6270
6,5x60 **STOCK OFF** LP-6270



LISTELO SNUG BEIGE
6,5x62 **STOCK OFF** LP-6270
6,5x60 **STOCK OFF** LP-6270



LISTELO SNUG GREY
6,5x62 **STOCK OFF** LP-6270
6,5x60 **STOCK OFF** LP-6270



BARRA NEST BEIGE
10x62 LP-6320



BARRA NEST GREY
10x62 LP-6320



BARRA INOX BRILHO ✕
2x0,8x100 LP-6348



Barra Inox



BARRA INOX BRILHO ✕
1x0,8x100 LP-6240



LISTELO BRUSHED GOLD
0,5x1,1x100 LP-6420
0,5x0,9x60 LP-6340



Listelo Brushed
Listelo Shine



LISTELO BRUSHED SILVER
0,5x1,1x100 LP-6348
0,5x0,9x60 LP-6280



LISTELO SHINE SILVER ✕
0,5x1,1x100 LP-6348
0,5x0,9x60 LP-6280



LISTELO BRUSHED BRONZE
0,5x1,1x100 LP-6420
0,5x0,9x60 LP-6340

- Arise
- Avenue
- Balance
- Canyon
- Core
- Genesis
- Gravity
- Ground
- Light
- Marble
- Mémorable
- Metallic
- Native
- Nest**
- Precious
- Pulse
- Sense
- Splash
- Timber
- Urban
- Wooden



Core Beige
35 x 100 Ret.

Core

Collection

DOWNLOAD
CATALOGUE



VIEW ONLINE



Index ▾

Colour Map ▾

Collections ▾

- Arise
- Avenue
- Balance
- Canyon
- Core**
- Genesis
- Gravity
- Ground
- Light
- Marble
- Mémorable
- Metallic
- Native
- Nest
- Precious
- Pulse
- Sense
- Splash
- Timber
- Urban
- Wooden



35 x 100 8 mm

30 x 60 7 mm

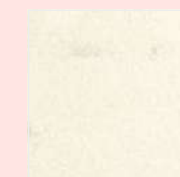

white



beige



light grey



grey

LOVE
CERAMIC TILES

Technical Specifications ▾

Core
Collection

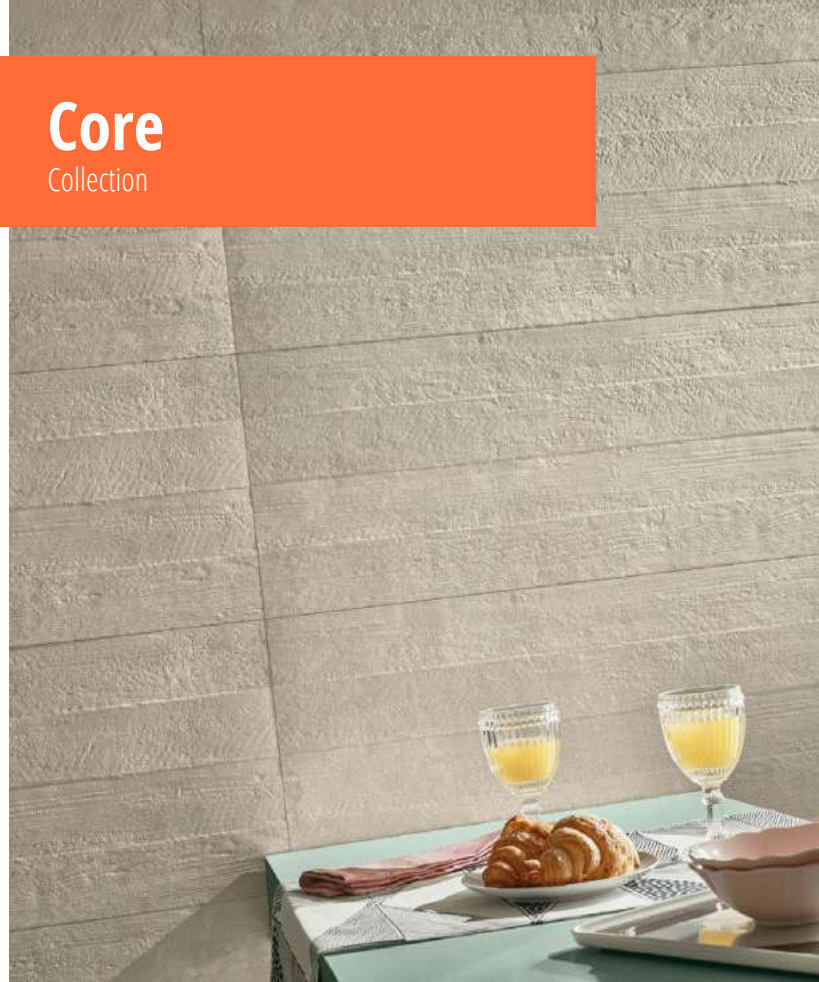

Core
Collection

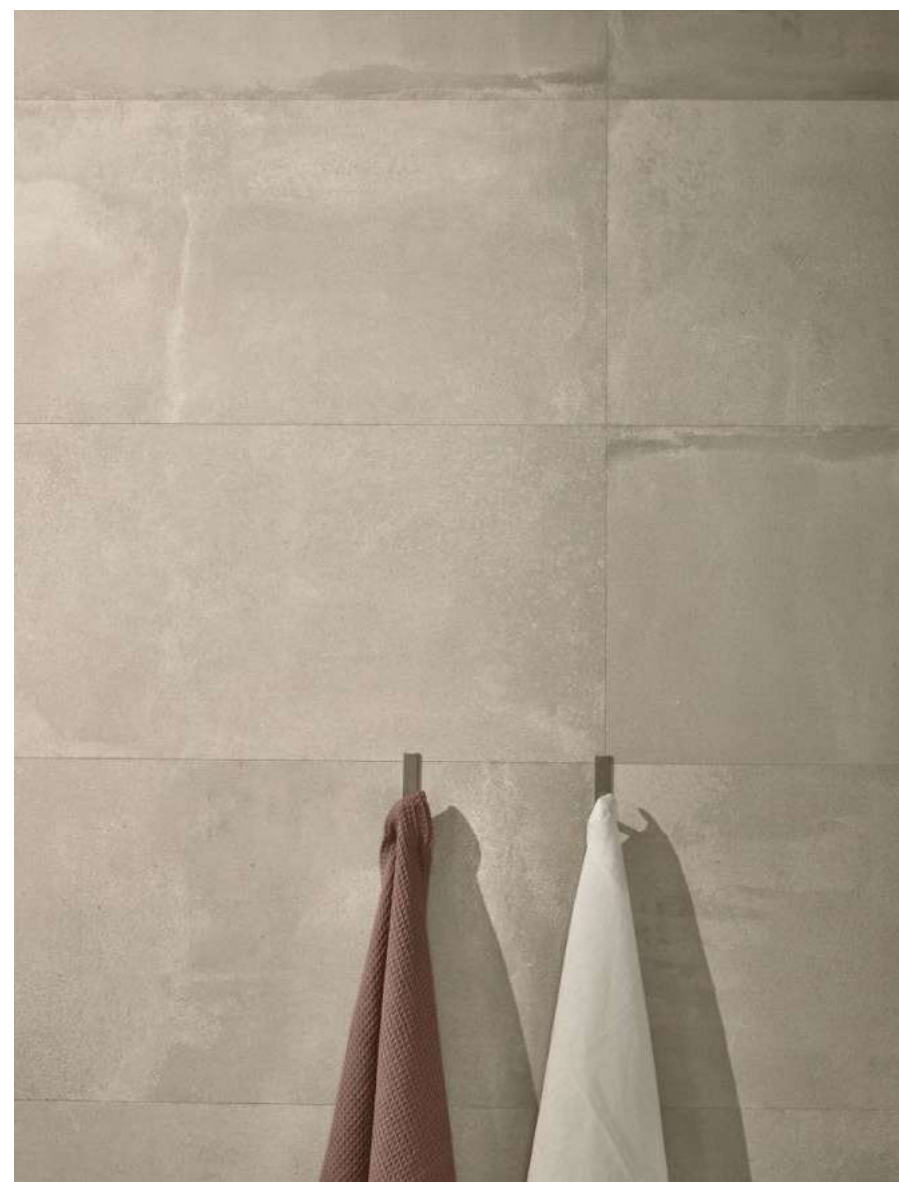

Index ▾

Colour Map ▾

Collections ▾

- Arise
- Avenue
- Balance
- Canyon
- Core**
- Genesis
- Gravity
- Ground
- Light
- Marble
- Mémorable
- Metallic
- Native
- Nest
- Precious
- Pulse
- Sense
- Splash
- Timber
- Urban
- Wooden

Technical Specifications ▾

Core
Collection

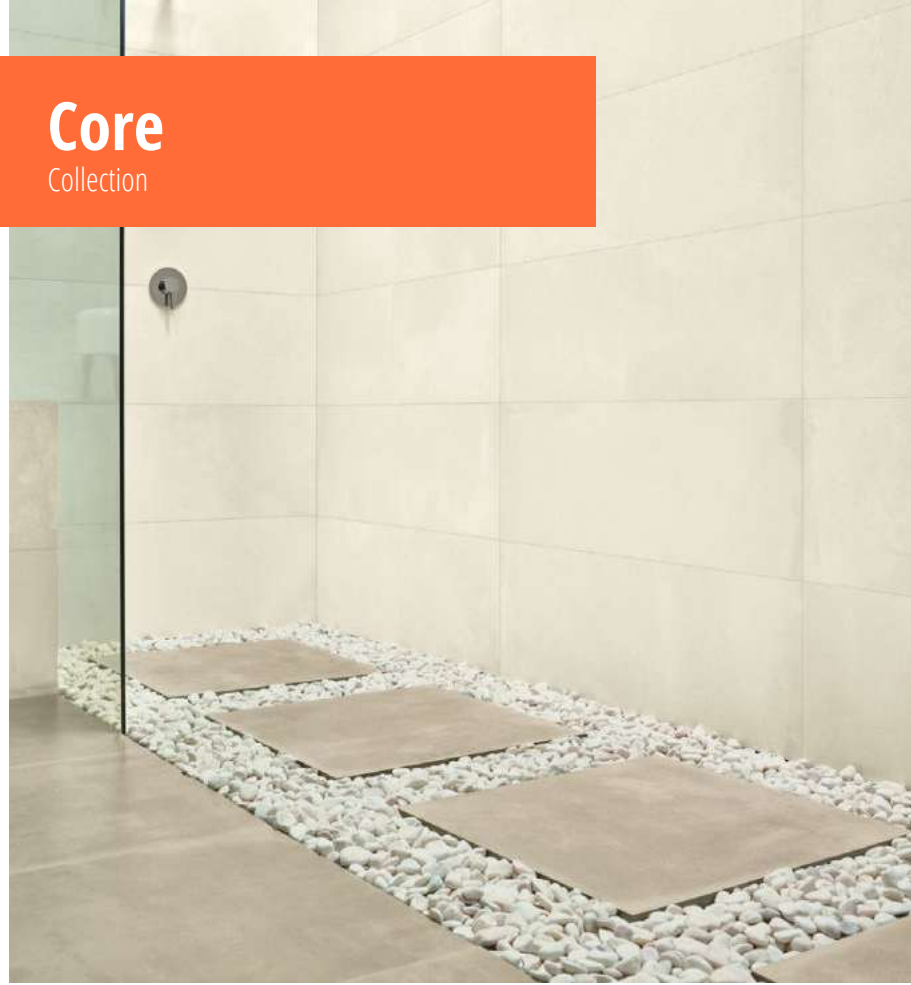

Core
Collection



Index ▾

Colour Map ▾

Collections ▾

- Arise
- Avenue
- Balance
- Canyon
- Core**
- Genesis
- Gravity
- Ground
- Light
- Marble
- Mémorable
- Metallic
- Native
- Nest
- Precious
- Pulse
- Sense
- Splash
- Timber
- Urban
- Wooden

Technical Specifications ▾



35x100 > 8 mm | 30x60 > 7 mm



CORE BEIGE
35x100 Ret. **LT-8120**
30x60 Ret. **LT-6830**



CORE WHITE
35x100 Ret. **LT-8120**
30x60 Ret. **LT-6830**



CORE LIGHT GREY
35x100 Ret. **LT-8120**
30x60 Ret. **LT-6830**



CORE GREY
35x100 Ret. **LT-8120**
30x60 Ret. **LT-6830**



35x100 > 8 mm | 30x60 > 7 mm



FORMWORK BEIGE
35x100 Ret. **LT-8290**
30x60 Ret. **LT-7070**



TRACE BEIGE
35x100 Ret. **LT-8365**



FORMWORK WHITE
35x100 Ret. **LT-8290**
30x60 Ret. **LT-7070**



TRACE WHITE
35x100 Ret. **LT-8365**



FORMWORK LIGHT GREY
35x100 Ret. **LT-8290**
30x60 Ret. **LT-7070**



TRACE LIGHT GREY
35x100 Ret. **LT-8365**



FORMWORK GREY
35x100 Ret. **LT-8290**
30x60 Ret. **LT-7070**



TRACE GREY
35x100 Ret. **LT-8365**

- Arise
- Avenue
- Balance
- Canyon
- Core**
- Genesis
- Gravity
- Ground
- Light
- Marble
- Mémorable
- Metallic
- Native
- Nest
- Precious
- Pulse
- Sense
- Splash
- Timber
- Urban
- Wooden



8 mm



DISTORTER BEIGE
35x100 Ret. LP-6348



DISTORTER WHITE
35x100 Ret. LP-6348



DISTORTER LIGHT GREY
35x100 Ret. LP-6348



DISTORTER GREY
35x100 Ret. LP-6348



DAZZLE WHITE
35x100 Ret. LP-6470



DAZZLE LIGHT GREY
35x100 Ret. LP-6470



8 mm



INNER BEIGE
35x100 Ret. LP-6530



INNER WHITE
35x100 Ret. LP-6530



INNER BLUE
35x100 Ret. LP-6530

Collections ▾

- Arise
- Avenue
- Balance
- Canyon
- Core**
- Genesis
- Gravity
- Ground
- Light
- Marble
- Mémorable
- Metallic
- Native
- Nest
- Precious
- Pulse
- Sense
- Splash
- Timber
- Urban
- Wooden



8 mm



MOSAIC CORE BEIGE
17x17 (1,9x1,9) LP-6230



MOSAIC CORE WHITE
17x17 (1,9x1,9) LP-6230



MOSAIC CORE LIGHT GREY
17x17 (1,9x1,9) LP-6230



MOSAIC CORE GREY
17x17 (1,9x1,9) LP-6230



Listelo Brushed
Listelo Shine

LISTELO BRUSHED GOLD
0,5x1,1x100 LP-6420
0,5x0,9x60 LP-6340

LISTELO BRUSHED SILVER
0,5x1,1x100 LP-6348
0,5x0,9x60 LP-6280

LISTELO SHINE SILVER
0,5x1,1x100 LP-6348
0,5x0,9x60 LP-6280

LISTELO BRUSHED BRONZE
0,5x1,1x100 LP-6420
0,5x0,9x60 LP-6340

PAVIMENTOS COORDENADOS | COORDINATED FLOOR TILES | SOLS COORDONÉS
KOORDINIERTER BODEN FLIESEN | КООРДИНИРОВАННАЯ НАПОЛЬНАЯ ПЛИТКА | PAVIMENTI COORDINATI



NATIVE LIGHT BEIGE



NATIVE DARK BEIGE



ARISE BEIGE



BALANCE BEIGE



TIMBER LIGHT BEIGE



TIMBER BEIGE



WOODEN DARK BEIGE



WOODEN BROWN



CORE BEIGE



ARISE GREY



BALANCE LIGHT GREY



BALANCE GREY



NATIVE LIGHT BEIGE

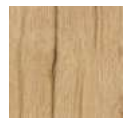

NATIVE DARK BEIGE



NATIVE TORTORA



WOODEN BEIGE



WOODEN DARK BEIGE



WOODEN BROWN



CORE WHITE



BALANCE LIGHT GREY



BALANCE GREY



GROUND LIGHT GREY



GROUND GREY



NATIVE LIGHT BEIGE



NATIVE TORTORA



NATIVE GREY



WOODEN TORTORA



CORE LIGHT GREY



ARISE GREY



ARISE ANTHRACITE



BALANCE LIGHT GREY



BALANCE GREY



NATIVE GREY



TIMBER TORTORA



CORE GREY

Arise

Avenue

Balance

Canyon

Core

Genesis

Gravity

Ground

Light

Marble

Mémorable

Metallic

Native

Nest

Precious

Pulse

Sense

Splash

Timber

Urban

Wooden



Urban

Collection

DOWNLOAD CATALOGUE  VIEW ONLINE 

Index ▾

Colour Map ▾

Collections ▾

- Arise
- Avenue
- Balance
- Canyon
- Core
- Genesis
- Gravity
- Ground
- Light
- Marble
- Mémorable
- Metallic
- Native
- Nest
- Precious
- Pulse
- Sense
- Splash
- Timber
- Urban**
- Wooden



35 x 100 

30 x 60 

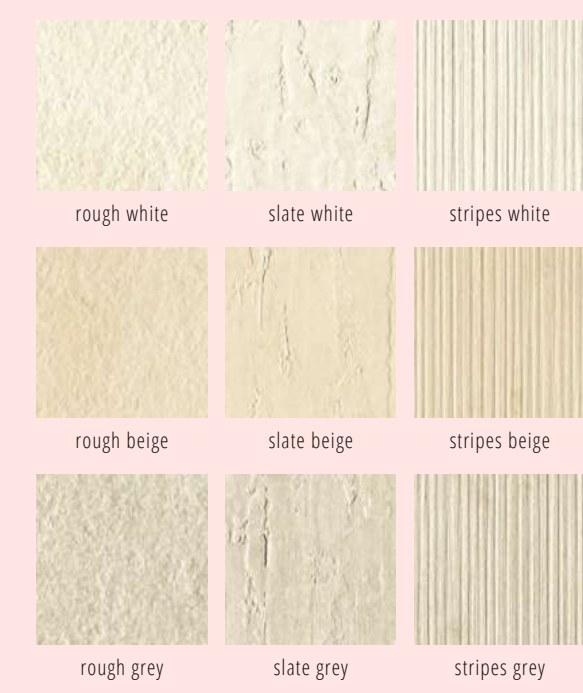

Urban Slate Beige 35 x 100 Ret. Urban Stripes Beige 35 x 100 Ret.



Technical Specifications ▾



Urban Rough White
35 x 100 Ret.

Collections ▾

- Arise
- Avenue
- Balance
- Canyon
- Core
- Genesis
- Gravity
- Ground
- Light
- Marble
- Mémorable
- Metallic
- Native
- Nest
- Precious
- Pulse
- Sense
- Splash
- Timber
- Urban**
- Wooden

Urban

Collection

Urban

Collection



Index ▾

Colour Map ▾

Collections ▾

- Arise
- Avenue
- Balance
- Canyon
- Core
- Genesis
- Gravity
- Ground
- Light
- Marble
- Mémorable
- Metallic
- Native
- Nest
- Precious
- Pulse
- Sense
- Splash
- Timber
- Urban**
- Wooden

Technical Specifications ▾

LOVE
CERAMIC TILES

Urban Slate Grey
35 x 100 Ret.

Urban Stripes Grey
35 x 100 Ret.

Ground Grey
60 x 60 Ret.



35x100 x 8 mm | 30x60 x 7 mm



URBAN ROUGH WHITE
35x100 Ret. **LT-8120**
30x60 Ret. **LT-6830**



URBAN SLATE WHITE
35x100 Ret. **LT-8120**
30x60 Ret. **LT-6830**

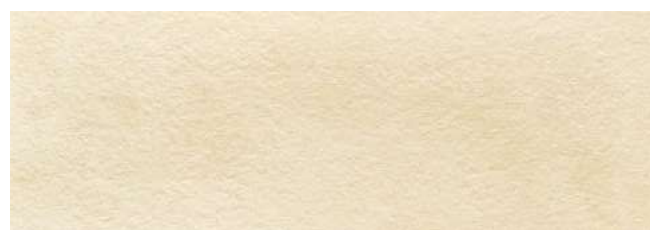

URBAN ROUGH BEIGE
35x100 Ret. **LT-8120**
30x60 Ret. **LT-6830**



URBAN SLATE BEIGE
35x100 Ret. **LT-8120**
30x60 Ret. **LT-6830**



URBAN ROUGH GREY
35x100 Ret. **LT-8120**
30x60 Ret. **LT-6830**



URBAN SLATE GREY
35x100 Ret. **LT-8120**
30x60 Ret. **LT-6830**



URBAN STRIPES WHITE
35x100 Ret. **LT-8120**
30x60 Ret. **LT-6830**



URBAN STRIPES BEIGE
35x100 Ret. **LT-8120**
30x60 Ret. **LT-6830**



URBAN STRIPES GREY
35x100 Ret. **LT-8120**
30x60 Ret. **LT-6830**



35x100 x 8 mm | 30x60 x 7 mm



TOWN WHITE *
35x100 Ret. **LT-8365**
30x60 Ret. **LT-7145**



TOWN BEIGE *
35x100 Ret. **LT-8365**
30x60 Ret. **LT-7145**



TOWN GREY *
35x100 Ret. **LT-8365**
30x60 Ret. **LT-7145**

Os diferentes desenhos são embalados aleatoriamente.
The available patterns are packed randomly.
Les différents motifs sont emballés aléatoirement.
Die verschiedenen Grafiken sind aleatorisch eingepackt.
Различные дизайны упакованы в случайном порядке
I diversi motivi sono imballati in modo casuale.

- Arise
- Avenue
- Balance
- Canyon
- Core
- Genesis
- Gravity
- Ground
- Light
- Marble
- Mémorable
- Metallic
- Native
- Nest
- Precious
- Pulse
- Sense
- Splash
- Timber
- Urban**
- Wooden



8 mm



MOSAIC URBAN WHITE
20x20 (1,9x1,9) LP-6240



MOSAIC URBAN BEIGE
20x20 (1,9x1,9) LP-6240

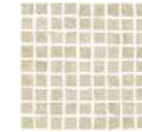

MOSAIC URBAN GREY
20x20 (1,9x1,9) LP-6240

7 mm

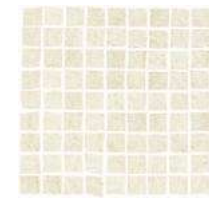

MOSAIC URBAN CITY WHITE
30x30 (3x3) LP-6270



MOSAIC URBAN CITY BEIGE
30x30 (3x3) LP-6270



MOSAIC URBAN CITY GREY
30x30 (3x3) LP-6270



Listelo Brushed
Listelo Shine

LISTELO BRUSHED GOLD

0,5x1,1x100
0,5x0,9x60

LP-6420
LP-6340

LISTELO BRUSHED SILVER

0,5x1,1x100
0,5x0,9x60

LP-6348
LP-6280

LISTELO SHINE SILVER

0,5x1,1x100
0,5x0,9x60

LP-6348
LP-6280

LISTELO BRUSHED BRONZE

0,5x1,1x100
0,5x0,9x60

LP-6420
LP-6340

PAVIMENTOS COORDENADOS | COORDINATED FLOOR TILES | SOLS COORDONÉS
KOORDINIERTER BODEN FLIESEN | КООРДИНИРОВАННАЯ НАПОЛЬНАЯ ПЛИТКА | PAVIMENTI COORDINATI

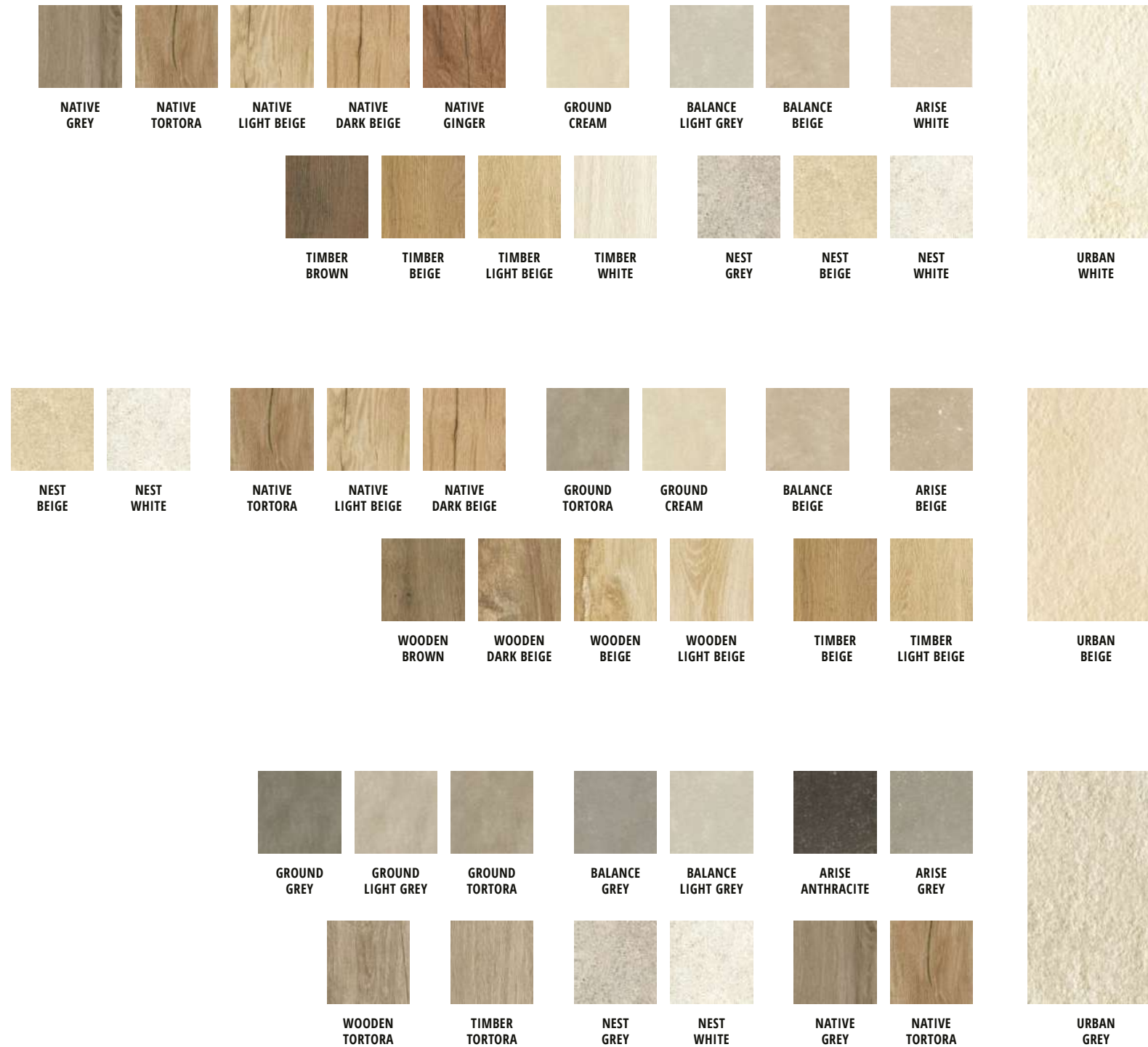

Collections

- Arise
- Avenue
- Balance
- Canyon
- Core
- Genesis
- Gravity
- Ground
- Light
- Marble
- Mémorable
- Metallic
- Native
- Nest
- Precious
- Pulse
- Sense
- Splash
- Timber
- Urban**
- Wooden



Genesis Shell Marine Blue Matt 35 x 100 Ret. Genesis Marine Blue Matt 35 x 100 Ret. Genesis White Matt 35 x 100 Ret. Native Ginger 20 x 100

Genesis

Collection

VIEW ONLINE

DOWNLOAD CATALOGUE

45 x 120

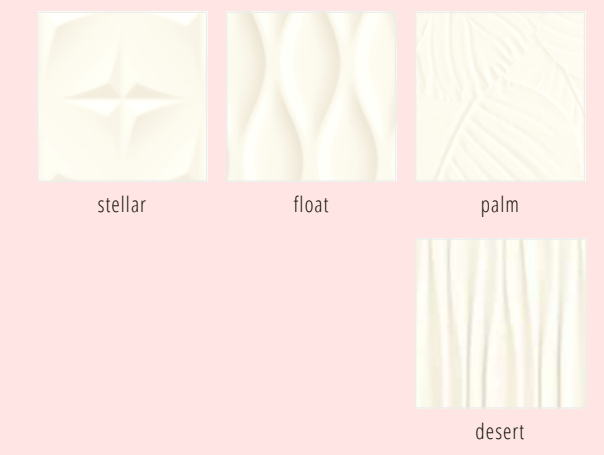

35 x 100

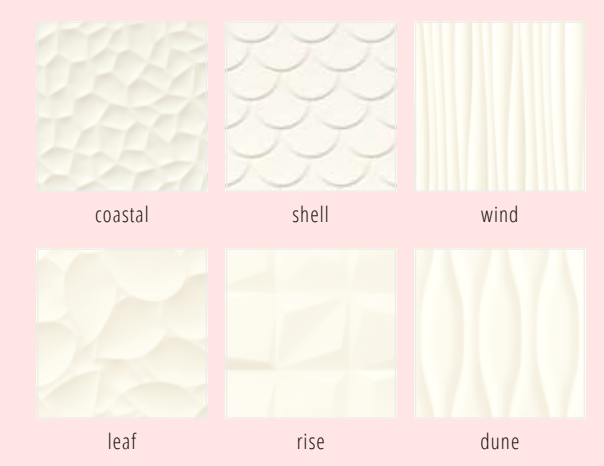

30 x 60



Index ▾

Colour Map ▾

Collections ▾

- Arise
- Avenue
- Balance
- Canyon
- Core
- Genesis**
- Gravity
- Ground
- Light
- Marble
- Mémorable
- Metallic
- Native
- Nest
- Precious
- Pulse
- Sense
- Splash
- Timber
- Urban
- Wooden

Technical Specifications ▾



Genesis

Collection



Genesis

Collection



Genesis Coastal White Matt
35 x 100 Ret.

Genesis Green Matt
35 x 100 Ret.

Balance Beige
80 x 80 Ret.

Mosaic Balance Beige
30 x 30 Touch

Index ▾

Colour Map ▾

Collections ▾

- Arise
- Avenue
- Balance
- Canyon
- Core
- Genesis**
- Gravity
- Ground
- Light
- Marble
- Mémorable
- Metallic
- Native
- Nest
- Precious
- Pulse
- Sense
- Splash
- Timber
- Urban
- Wooden

Technical Specifications ▾

Genesis

Collection

Genesis

Collection



Index ▼

Colour Map ▼

Collections ▼

- Arise
- Avenue
- Balance
- Canyon
- Core
- Genesis**
- Gravity
- Ground
- Light
- Marble
- Mémorable
- Metallic
- Native
- Nest
- Precious
- Pulse
- Sense
- Splash
- Timber
- Urban
- Wooden

Technical Specifications ▼

Genesis

Collection



Genesis

Collection

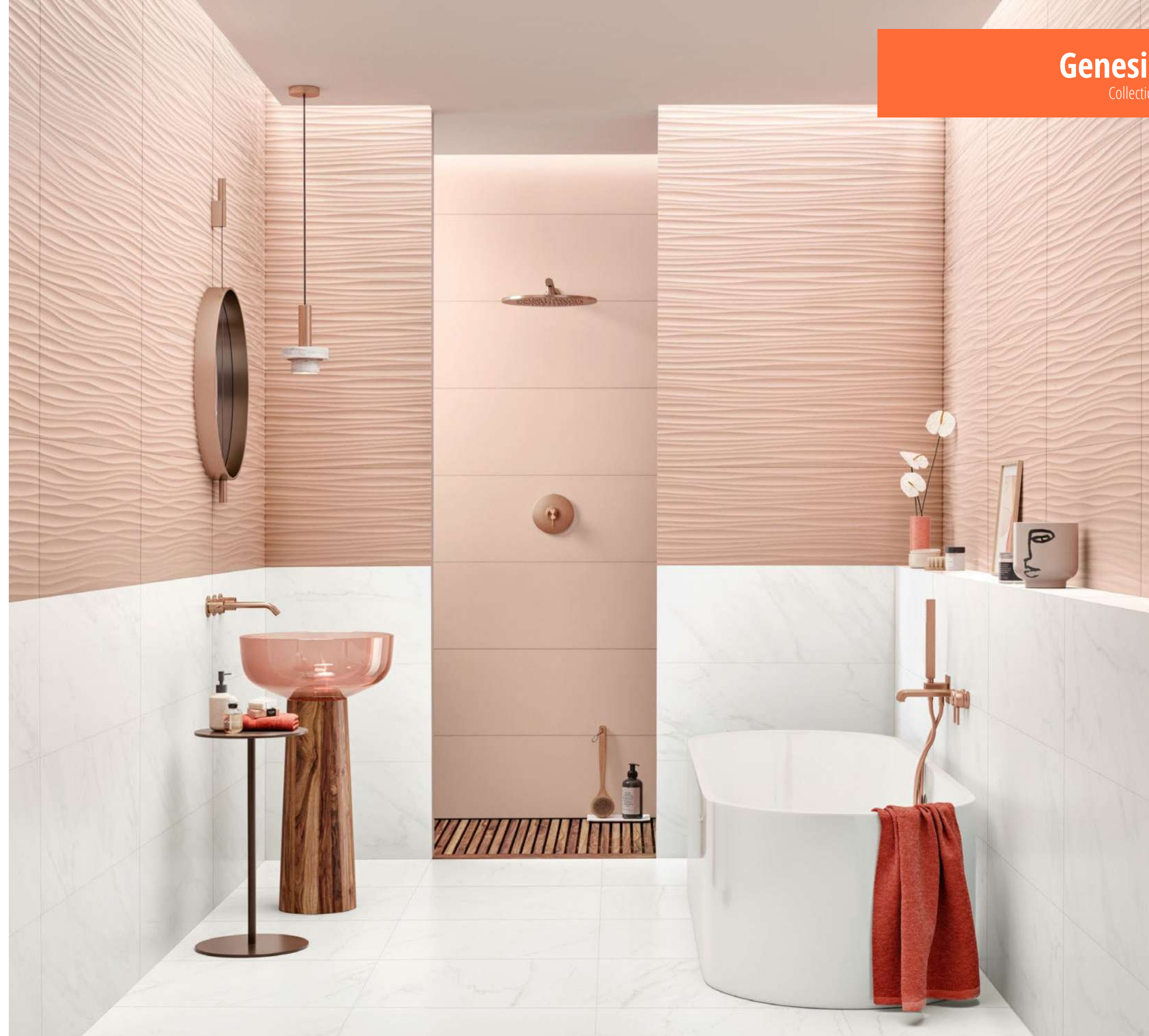

Index ▾

Colour Map ▾

Collections ▾

- Arise
- Avenue
- Balance
- Canyon
- Core
- Genesis**
- Gravity
- Ground
- Light
- Marble
- Mémorable
- Metallic
- Native
- Nest
- Precious
- Pulse
- Sense
- Splash
- Timber
- Urban
- Wooden

Technical Specifications ▾

LOVE
CERAMIC TILES

Genesis Wind Pink Matt
35 x 100 Ret.

Genesis Pink Matt
35 x 100 Ret.

Marble White Matt
35 x 100 Ret.

Marble White Matt
60 x 60 Ret.

Genesis

Collection

Genesis

Collection



Index ▼

Colour Map ▼

Collections ▼

- Arise
- Avenue
- Balance
- Canyon
- Core

Genesis

- Gravity
- Ground
- Light
- Marble
- Mémorable
- Metallic
- Native
- Nest
- Precious
- Pulse
- Sense
- Splash
- Timber
- Urban
- Wooden

Technical Specifications ▼

LOVE
CERAMIC TILES

Genesis Desert White Shine
45 x 120 Ret.

Metallic Iron
60 x 60 Ret.

Genesis

Collection



Genesis

Collection



Genesis White Matt
45 x 120 Ret.

Genesis Palm White Matt
45 x 120 Ret.

Metallic Rust
60 x 60 Ret.

Index ▾

Colour Map ▾

Collections ▾

Arise

Avenue

Balance

Canyon

Core

Genesis

Gravity

Ground

Light

Marble

Mémorable

Metallic

Native

Nest

Precious

Pulse

Sense

Splash

Timber

Urban

Wooden

Technical Specifications ▾

Genesis

Collection

Genesis

Collection



Index ▾

Colour Map ▾

Collections ▾

- Arise
- Avenue
- Balance
- Canyon
- Core

Genesis

- Gravity
- Ground
- Light
- Marble
- Mémorable
- Metallic
- Native
- Nest
- Precious
- Pulse
- Sense
- Splash
- Timber
- Urban
- Wooden

Technical Specifications ▾

LOVE
CERAMIC TILES

Genesis Float Red Matt
45 x 120 Ret.

Timber Light Beige
20 x 100

Genesis

Collection

Genesis

Collection

Index ▾

Colour Map ▾

Collections ▾

Arise

Avenue

Balance

Canyon

Core

Genesis

Gravity

Ground

Light

Marble

Mémorable

Metallic

Native

Nest

Precious

Pulse

Sense

Splash

Timber

Urban

Wooden



Genesis White Matt 45 x 120 Ret. Listelo Blink Brushed Bronze 0,5 x 120 Genesis Palm Copper Matt 45 x 120 Ret. Marble White Matt 60 x 60 Ret.



Genesis Coastal Black Matt 35 x 100 Ret. Genesis Black Matt 35 x 100 Ret.

Technical Specifications ▾

Genesis

Collection



Genesis

Collection

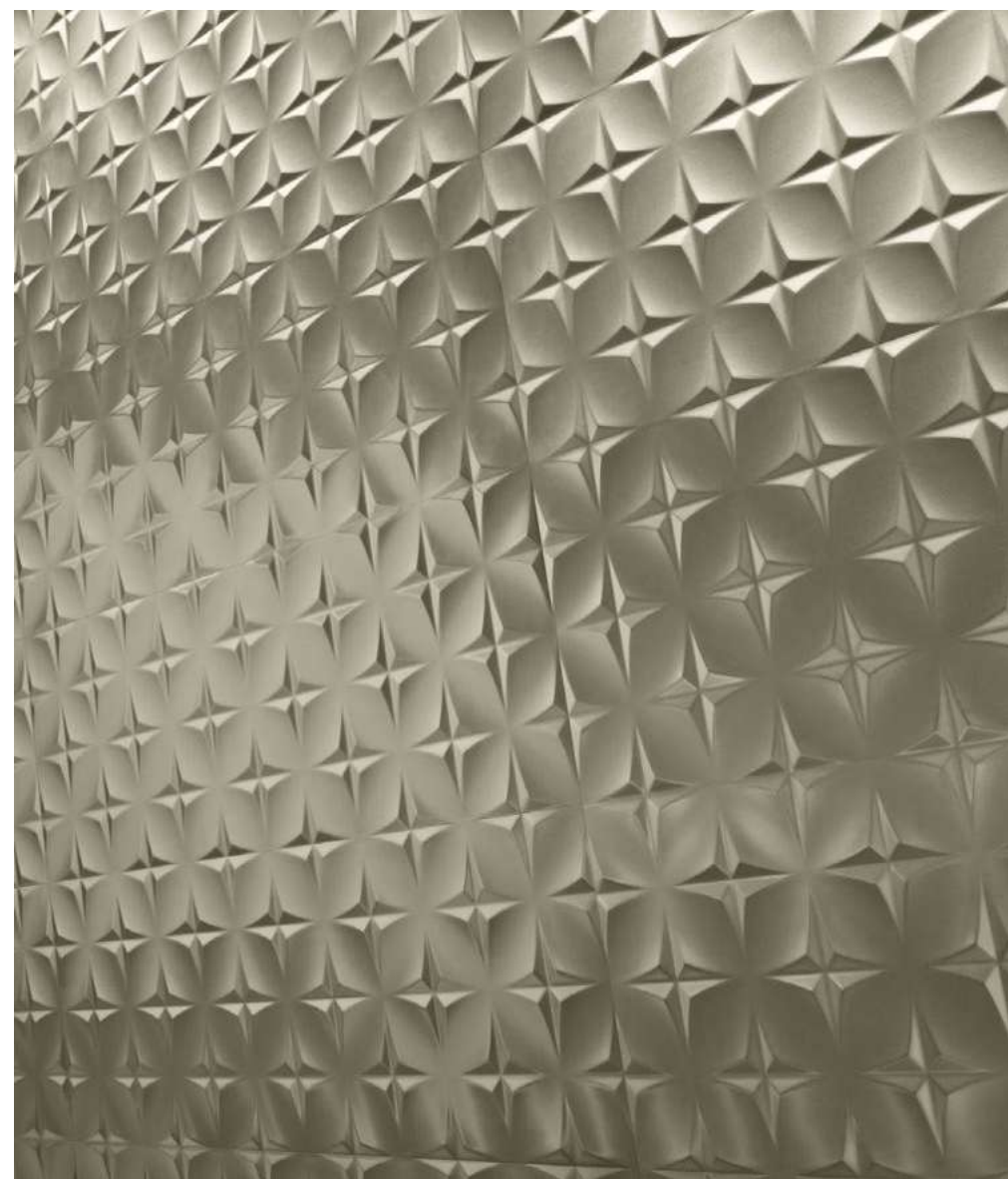
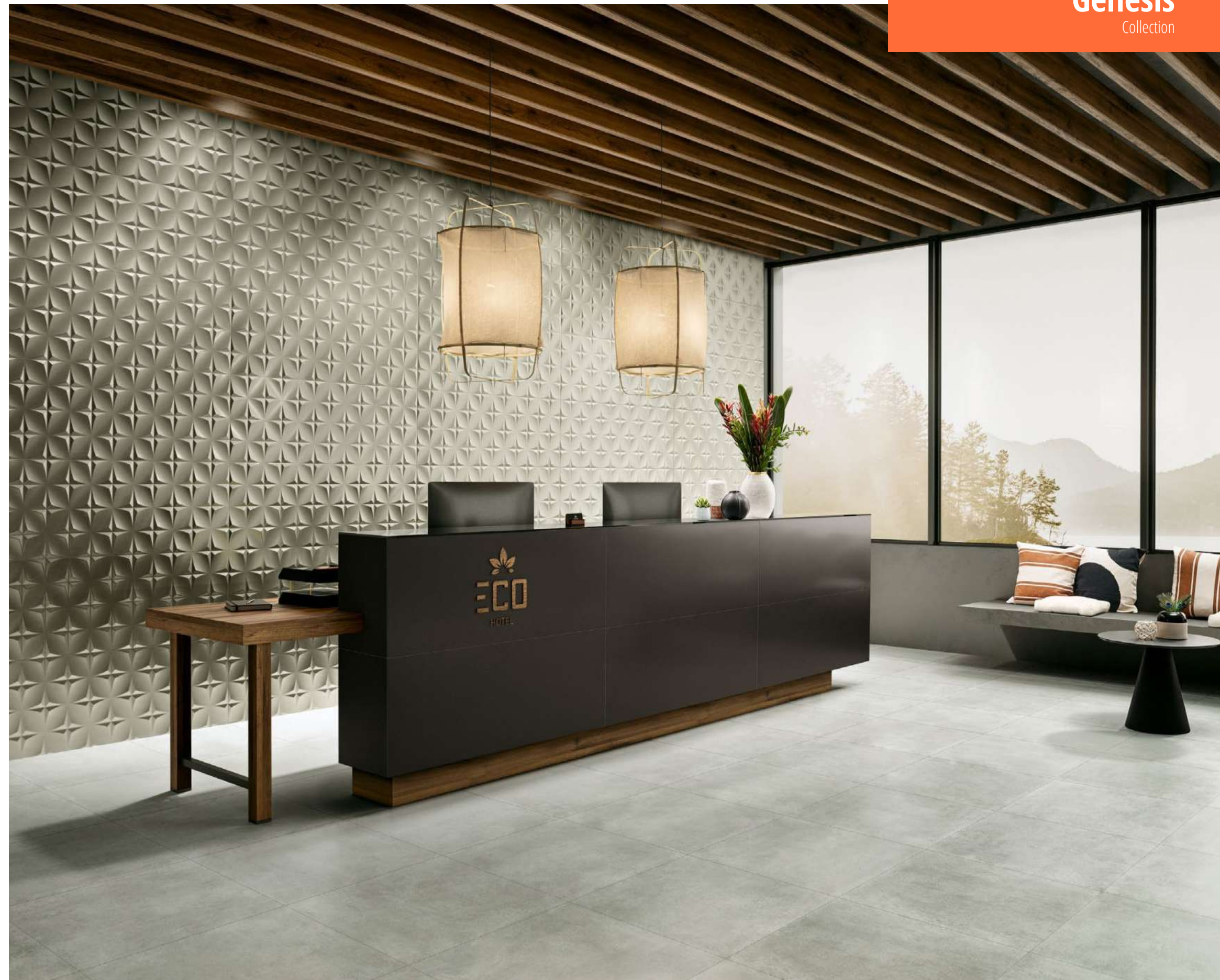

Index ▾

Colour Map ▾

Collections ▾

- Arise
- Avenue
- Balance
- Canyon
- Core
- Genesis**
- Gravity
- Ground
- Light
- Marble
- Mémorable
- Metallic
- Native
- Nest
- Precious
- Pulse
- Sense
- Splash
- Timber
- Urban
- Wooden

Technical Specifications ▾

LOVE
CERAMIC TILES

Genesis Stellar Silver Matt
45 x 120 Ret.

Genesis Black Matt
45 x 120 Ret.

Metallic Steel
60 x 60 Ret.

Genesis

Collection



Genesis

Collection



Index ▾

Colour Map ▾

Collections ▾

- Arise
- Avenue
- Balance
- Canyon
- Core

Genesis

- Gravity
- Ground
- Light
- Marble
- Mémorable
- Metallic
- Native
- Nest
- Precious
- Pulse
- Sense
- Splash
- Timber
- Urban
- Wooden

Technical Specifications ▾

LOVE
CERAMIC TILES

Genesis Dune White Matt
35 x 100 Ret.

Genesis White Matt
35 x 100 Ret.

Timber Tortora
20 x 100

Genesis

Collection

Genesis

Collection



Index ▾

Colour Map ▾

Collections ▾

- Arise
- Avenue
- Balance
- Canyon
- Core
- Genesis**
- Gravity
- Ground
- Light
- Marble
- Mémorable
- Metallic
- Native
- Nest
- Precious
- Pulse
- Sense
- Splash
- Timber
- Urban
- Wooden

LOVE
CERAMIC TILES

Genesis Wind White Matt
35 x 100 Ret.

Genesis White Matt
35 x 100 Ret.

Timber Beige
20 x 100

Technical Specifications ▾

Genesis

Collection



Genesis

Collection



Index ▾

Colour Map ▾

Collections ▾

- Arise
- Avenue
- Balance
- Canyon
- Core
- Genesis**
- Gravity
- Ground
- Light
- Marble
- Mémorable
- Metallic
- Native
- Nest
- Precious
- Pulse
- Sense
- Splash
- Timber
- Urban
- Wooden

Technical Specifications ▾

Genesis

Collection



Genesis

Collection



Index ▼

Colour Map ▼

Collections ▼

- Arise
- Avenue
- Balance
- Canyon
- Core
- Genesis**
- Gravity
- Ground
- Light
- Marble
- Mémorable
- Metallic
- Native
- Nest
- Precious
- Pulse
- Sense
- Splash
- Timber
- Urban
- Wooden

LOVE
CERAMIC TILES

Genesis Deep Blue Matt
35 x 100 Ret.

Genesis White Matt
35 x 100 Ret.

Genesis Leaf White Matt
35 x 100 Ret.

Technical Specifications ▼

Genesis

Collection



Genesis Skin White Matt
30 x 60 Ret.

Genesis Deep Blue Matt
30 x 60 Ret.

Wooden Beige
20 x 100

Genesis

Collection



Genesis Leaf Green Matt
30 x 60 Ret.

Index ▾

Colour Map ▾

Collections ▾

- Arise
- Avenue
- Balance
- Canyon
- Core

Genesis

- Gravity
- Ground
- Light
- Marble
- Mémorable
- Metallic
- Native
- Nest
- Precious
- Pulse
- Sense
- Splash
- Timber
- Urban
- Wooden

Technical Specifications ▾

Genesis

Collection



Genesis Reef White Matt
30 x 60 Ret. Metallic Carbon
60 x 60 Ret.

Genesis

Collection



Genesis Arid White Shine
30 x 60 Ret.

Index ▼

Colour Map ▼

Collections ▼

- Arise
- Avenue
- Balance
- Canyon
- Core
- Genesis**
- Gravity
- Ground
- Light
- Marble
- Mémorable
- Metallic
- Native
- Nest
- Precious
- Pulse
- Sense
- Splash
- Timber
- Urban
- Wooden

Technical Specifications ▼



45x120 > 9,5 mm | 35x100 > 8 mm | 30x60 > 7 mm

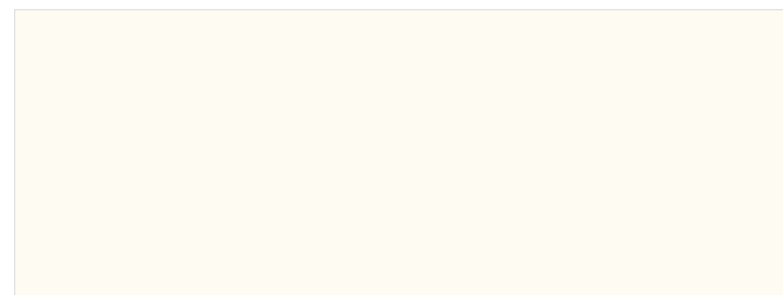

GENESIS WHITE MATT

45x120 Ret. **LT-8665**
35x100 Ret. **LT-8070**
30x60 Ret. **LT-6790**

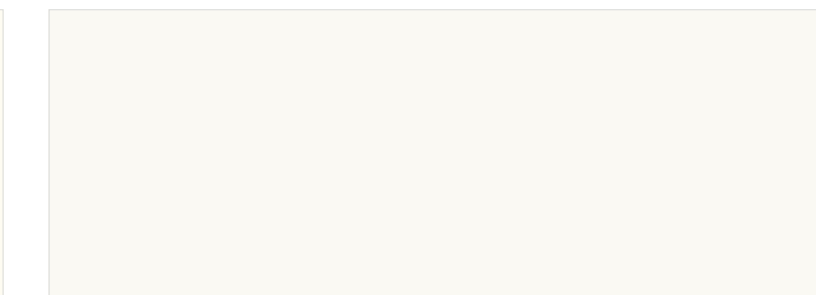

LIGHT BRANCO BRILHO

45x120 Ret. **LT-8695**
35x100 Ret. **LT-8120**
30x60 Ret. **LT-6830**

9,5 - 10,7 mm



GENESIS DESERT WHITE MATT

45x120 Ret. **LT-8890**



GENESIS DESERT WHITE SHINE

45x120 Ret. **LT-8890**



9,5 - 12,0 mm



GENESIS STELLAR WHITE MATT

45x120 Ret. **LT-8890**

9,0 - 11,9 mm



GENESIS FLOAT WHITE MATT

45x120 Ret. **LT-8890**

10,0 - 10,4 mm



GENESIS PALM WHITE MATT

45x120 Ret. **LT-8890**

- Arise
- Avenue
- Balance
- Canyon
- Core
- Genesis**
- Gravity
- Ground
- Light
- Marble
- Mémorable
- Metallic
- Native
- Nest
- Precious
- Pulse
- Sense
- Splash
- Timber
- Urban
- Wooden



9,0 - 10,0 mm



GENESIS WIND WHITE MATT
35x100 Ret. LT-8325



GENESIS WIND WHITE SHINE
35x100 Ret. LT-8325

9,9 - 10,8 mm



GENESIS LEAF WHITE MATT
35x100 Ret. LT-8325

8,8 - 10,1 mm



GENESIS DUNE WHITE MATT
35x100 Ret. LT-8325

8,8 - 10,5 mm



GENESIS RISE WHITE MATT
35x100 Ret. LT-8325

8,5 - 9,0 mm



GENESIS SHELL WHITE MATT
35x100 Ret. LT-8325

9,1 - 9,9 mm



GENESIS COASTAL WHITE MATT
35x100 Ret. LT-8325



7,5 - 8,5 mm



GENESIS RISE WHITE MATT
30x60 Ret. LT-7075

7,1 - 8,5 mm



GENESIS REEF WHITE MATT
30x60 Ret. LT-7075

7,5 - 8,5 mm



GENESIS SKIN WHITE MATT
30x60 Ret. LT-7075

6,9 - 8,1 mm



GENESIS LEAF WHITE MATT
30x60 Ret. LT-7075

7,0 - 7,3 mm



GENESIS ARID WHITE SHINE
30x60 Ret. LT-7075

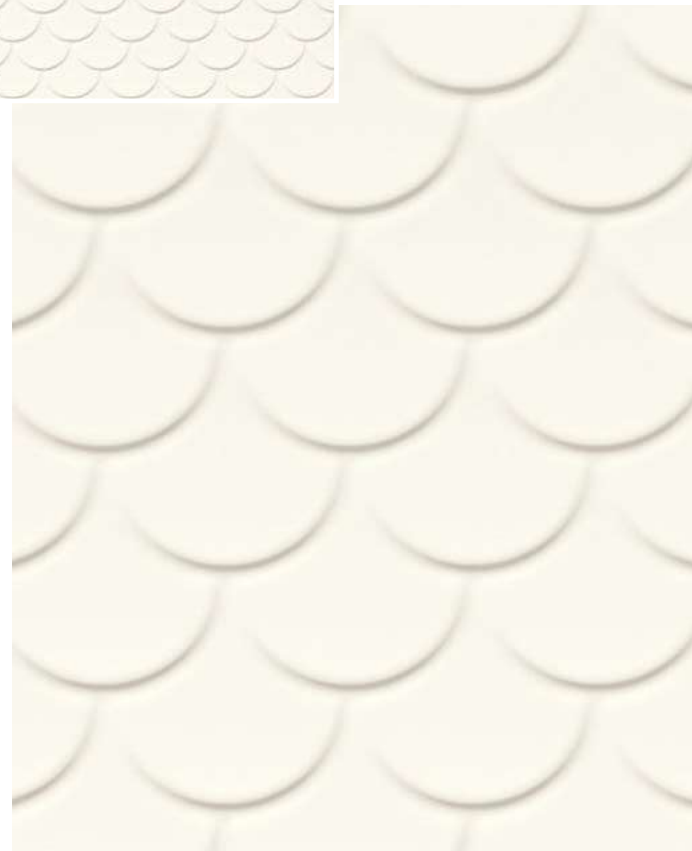

- Arise
- Avenue
- Balance
- Canyon
- Core
- Genesis**
- Gravity
- Ground
- Light
- Marble
- Mémorable
- Metallic
- Native
- Nest
- Precious
- Pulse
- Sense
- Splash
- Timber
- Urban
- Wooden



9,5 mm



GENESIS SAND MATT
45x120 Ret. **LT-8890**

9,5 - 12,0 mm

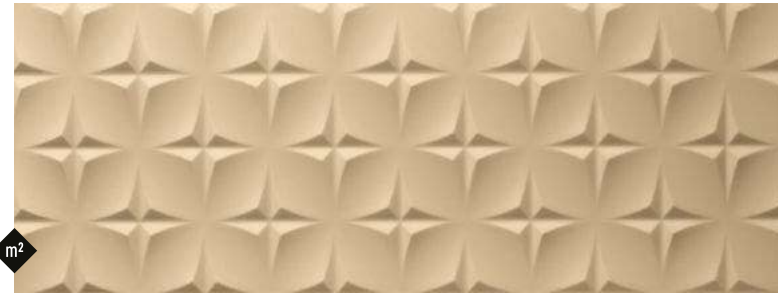

GENESIS STELLAR SAND MATT
45x120 Ret. **LT-8950**

9,0 - 11,9 mm



GENESIS FLOAT SAND MATT
45x120 Ret. **LT-8950**



9,5 mm



GENESIS RED MATT
45x120 Ret. **LT-9020**

9,5 - 12,0 mm

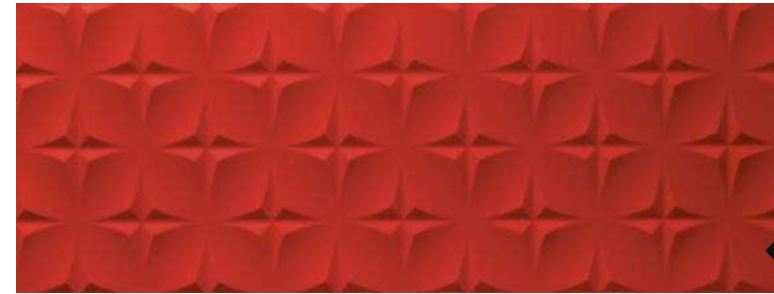

GENESIS STELLAR RED MATT
45x120 Ret. **LT-9050**

9,0 - 11,9 mm



GENESIS FLOAT RED MATT
45x120 Ret. **LT-9050**

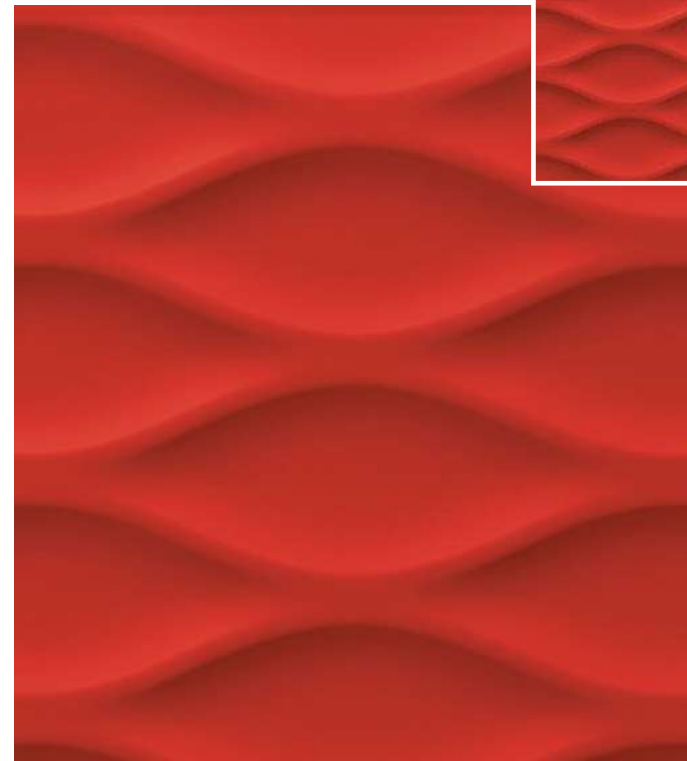

Collections ▾

- Arise
- Avenue
- Balance
- Canyon
- Core

Genesis

- Gravity
- Ground
- Light
- Marble
- Mémorable
- Metallic
- Native
- Nest
- Precious
- Pulse
- Sense
- Splash
- Timber
- Urban
- Wooden



45x120 > 9,5 mm | 35x100 > 8 mm

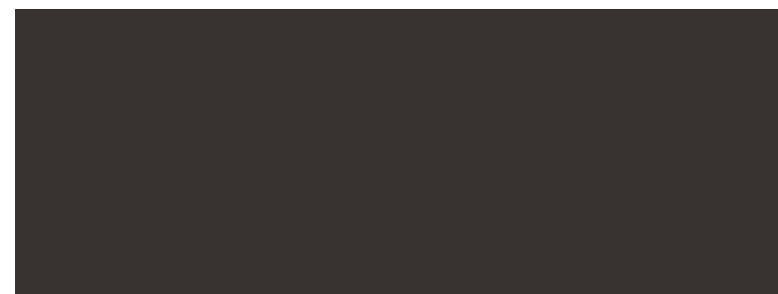

GENESIS BLACK MATT

45x120 Ret. **LT-8890**
35x100 Ret. **LT-8385**

9,5 - 12,0 mm

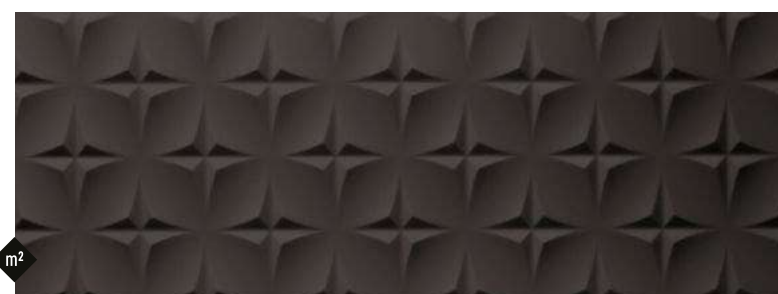

GENESIS STELLAR BLACK MATT

45x120 Ret. **LT-8950**

9,0 - 11,9 mm



GENESIS FLOAT BLACK MATT

45x120 Ret. **LT-8950**

9,1 - 9,9 mm



GENESIS COASTAL BLACK MATT

35x100 Ret. **LT-8420**

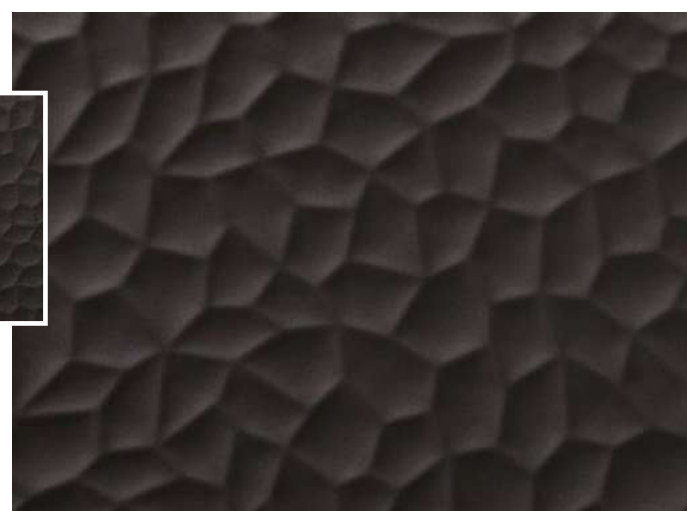

35x100 > 8 mm | 30x60 > 7 mm



GENESIS DEEP BLUE MATT

35x100 Ret. **LT-8385**
30x60 Ret. **LT-7115**

8,8 - 10,5 mm



GENESIS RISE DEEP BLUE MATT

35x100 Ret. **LT-8420**

35x100 > 9,9 - 10,8 mm | 30x60 > 6,9 - 8,1 mm



GENESIS LEAF DEEP BLUE MATT

35x100 Ret. **LT-8420**
30x60 Ret. **LT-7165**

7,1 - 8,5 mm

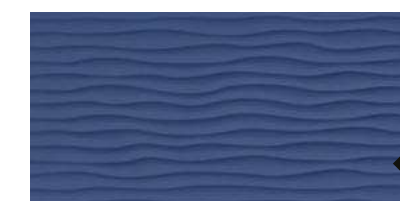

GENESIS REEF DEEP BLUE MATT

30x60 Ret. **LT-7165**



- Arise
- Avenue
- Balance
- Canyon
- Core

Genesis

- Gravity
- Ground
- Light
- Marble
- Mémorable
- Metallic
- Native
- Nest
- Precious
- Pulse
- Sense
- Splash
- Timber
- Urban
- Wooden



35x100 > 8 mm | 30x60 > 7 mm



GENESIS GREEN MATT
35x100 Ret. **LT-8385**
30x60 Ret. **LT-7115**

9,9 - 10,8 mm

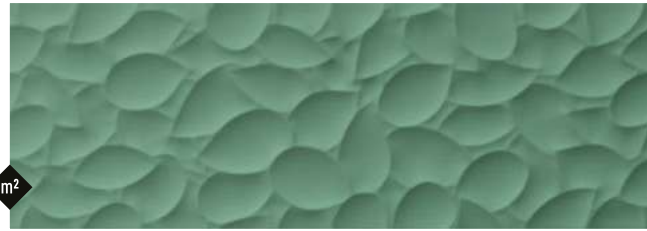

GENESIS LEAF GREEN MATT
35x100 Ret. **LT-8420**

6,9 - 8,1 mm

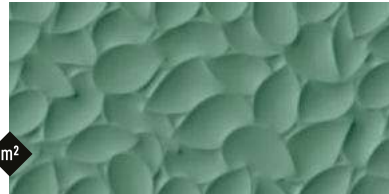

GENESIS LEAF GREEN MATT
30x60 Ret. **LT-7165**

7,1 - 8,5 mm

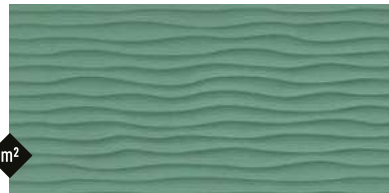

GENESIS REEF GREEN MATT
30x60 Ret. **LT-7165**

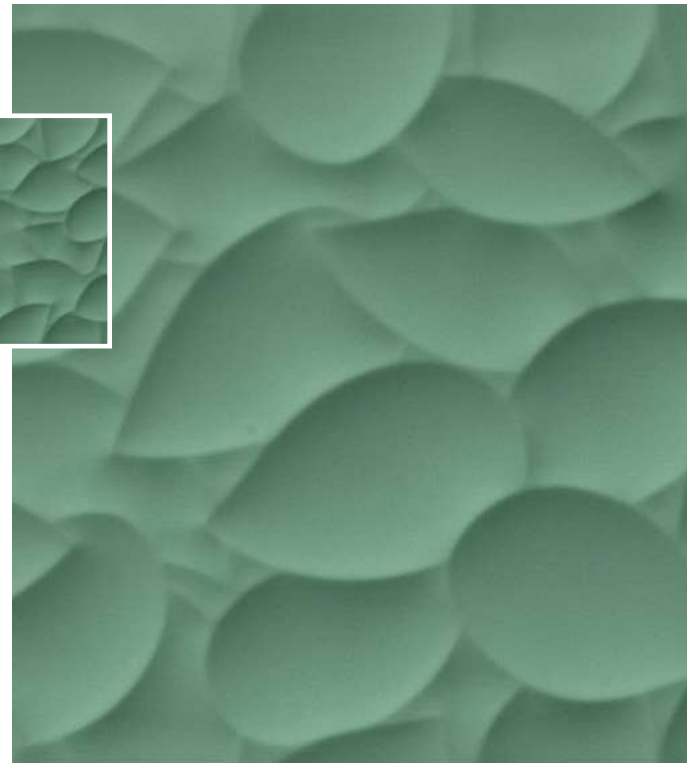

8 mm



GENESIS MARINE BLUE MATT
35x100 Ret. **LT-8385**

8,5 - 9,0 mm



GENESIS SHELL MARINE BLUE MATT
35x100 Ret. **LT-8420**

8 mm

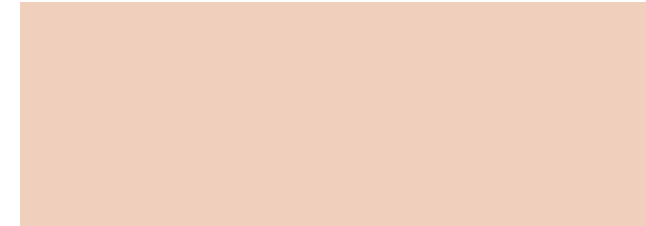

GENESIS PINK MATT
35x100 Ret. **LT-8385**

9,0 - 10,0 mm



GENESIS WIND PINK MATT
35x100 Ret. **LT-8420**

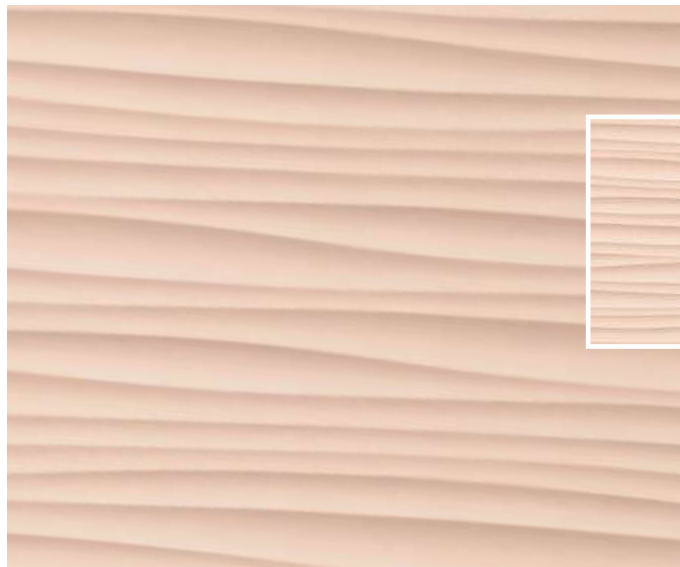

- Arise
- Avenue
- Balance
- Canyon
- Core
- Genesis**
- Gravity
- Ground
- Light
- Marble
- Mémorable
- Metallic
- Native
- Nest
- Precious
- Pulse
- Sense
- Splash
- Timber
- Urban
- Wooden



Listelo Brushed
Listelo Shine

LISTELO BRUSHED GOLD

0,5x1,1x100 **LP-6420**
0,5x0,9x60 **LP-6340**

LISTELO BRUSHED SILVER

0,5x1,1x100 **LP-6348**
0,5x0,9x60 **LP-6280**

✕ **LISTELO SHINE SILVER**

0,5x1,1x100 **LP-6348**
0,5x0,9x60 **LP-6280**

LISTELO BRUSHED BRONZE

0,5x1,1x100 **LP-6420**
0,5x0,9x60 **LP-6340**



Listelo Blink

LISTELO BLINK BRUSHED GOLD

0,5x1,2x120 **LP-6510**

LISTELO BLINK BRUSHED SILVER

0,5x1,2x120 **LP-6510**

LISTELO BLINK BRUSHED BRONZE

0,5x1,2x120 **LP-6510**

		WHITE MATT	BRANCO BRILHO WHITE SHINE	SAND MATT	PINK MATT	RED MATT	GREEN MATT	MARINE BLUE MATT	DEEP BLUE MATT	BLACK MATT
	STELLAR 45x120 Ret.	• LT-8890		• LT-8950		• LT-9050				• LT-8950
	DESERT 45x120 Ret.	• LT-8890	• LT-8890							
	FLOAT 45x120 Ret.	• LT-8890		• LT-8950		• LT-9050				• LT-8950
	PALM 45x120 Ret.	• LT-8890								
	COASTAL 35x100 Ret.	• LT-8325								• LT-8420
	SHELL 35x100 Ret.	• LT-8325						• LT-8420		
	DUNE 35x100 Ret.	• LT-8325								
	WIND 35x100 Ret.	• LT-8325	• LT-8325		• LT-8420					
	LEAF 35x100 Ret.	• LT-8325					• LT-8420		• LT-8420	
	LEAF 30x60 Ret.	• LT-7075					• LT-7165		• LT-7165	
	RISE 35x100 Ret.	• LT-8325							• LT-8420	
	RISE 30x60 Ret.	• LT-7075								
	ARID 30x60 Ret.		• LT-7075							
	REEF 30x60 Ret.	• LT-7075					• LT-7165		• LT-7165	
	SKIN 30x60 Ret.	• LT-7075								

- Arise
- Avenue
- Balance
- Canyon
- Core
- Genesis**
- Gravity
- Ground
- Light
- Marble
- Mémorable
- Metallic
- Native
- Nest
- Precious
- Pulse
- Sense
- Splash
- Timber
- Urban
- Wooden



± 9,0 - 10,0 mm



GENESIS WIND GOLD MATT
35x100 Ret. **LP-6620**



GENESIS WIND SILVER MATT
35x100 Ret. **LP-6620**



GENESIS WIND COPPER MATT
35x100 Ret. **LP-6645**

MATT

Também disponível nas estruturas:
Also available in structures:
Aussi disponible dans les structures :
Auch in Strukturen verfügbar:
Также доступны следующие фактуры:
Disponibile in struttura:

STELLAR, DESERT, FLOAT, PALM, DUNE, LEAF, RISE, REEF, SKIN, COASTAL, SHELL



GENESIS WIND GOLD SHINE
35x100 Ret. **LP-6620**



GENESIS WIND SILVER SHINE
35x100 Ret. **LP-6620**



GENESIS WIND COPPER SHINE
35x100 Ret. **LP-6645**

SHINE

Também disponível nas estruturas:
Also available in structures:
Aussi disponible dans les structures :
Auch in Strukturen verfügbar:
Также доступны следующие фактуры:
Disponibile in struttura:

DESERT, ARID

		 GOLD MATT	 GOLD SHINE	 SILVER MATT	 SILVER SHINE	 COPPER MATT	 COPPER SHINE
	STELLAR 45x120 Ret.	• LP-6670		• LP-6670		• LP-6700	
	DESERT 45x120 Ret.	• LP-6670	• LP-6670	• LP-6670	• LP-6670	• LP-6700	• LP-6700
	FLOAT 45x120 Ret.	• LP-6670		• LP-6670		• LP-6700	
	PALM 45x120 Ret.	• LP-6670		• LP-6670		• LP-6700	
	COASTAL 35x100 Ret.	• LP-6620		• LP-6620		• LP-6645	
	SHELL 35x100 Ret.	• LP-6620		• LP-6620		• LP-6645	
	DUNE 35x100 Ret.	• LP-6620		• LP-6620		• LP-6645	
	WIND 35x100 Ret.	• LP-6620	• LP-6620	• LP-6620	• LP-6620	• LP-6645	• LP-6645
	LEAF 35x100 Ret.	• LP-6620		• LP-6620		• LP-6645	
	LEAF 30x60 Ret.	• LP-6520		• LP-6520		• LP-6540	
	RISE 35x100 Ret.	• LP-6620		• LP-6620		• LP-6645	
	RISE 30x60 Ret.	• LP-6520		• LP-6520		• LP-6540	
	ARID 30x60 Ret.		• LP-6520		• LP-6520		• LP-6540
	REEF 30x60 Ret.	• LP-6520		• LP-6520		• LP-6540	
	SKIN 30x60 Ret.	• LP-6520		• LP-6520		• LP-6540	

Para informações sobre limpeza das decorações metálicas – Gold, Silver e Copper – por favor consulte o ponto 08 da página 391.
For further information on cleaning metallic decorations – Gold, Silver and Copper – please see section 08 from page 391.
Pour des informations concernant le nettoyage des décors métalliques – Gold, Silver et Copper – veuillez consulter le point 08 à la page 391.
Informationen zur Reinigung der Metalldekorationen - Gold, Silver und Copper - finden Sie in Punkt 08 auf Seite 391.
Информация по уходу и чистке металлических декоров - Gold, Silver и Copper - смотрите Пункт 08 на стр. 391.
Per informazioni per quanto riguarda la pulizia dei decori metallici – Gold, Silver e Copper – per favore vedere il punto 08 della pagina 391.

Collections ▾

- Arise
- Avenue
- Balance
- Canyon
- Core
- Genesis**
- Gravity
- Ground
- Light
- Marble
- Mémorable
- Metallic
- Native
- Nest
- Precious
- Pulse
- Sense
- Splash
- Timber
- Urban
- Wooden

Technical Specifications ▾



Splash Grey 20 x 60 Mosaic Responsive Green 20 x 20 Splash Green 20 x 60 Splash Cream 61 x 61

Splash

Collection

DOWNLOAD CATALOGUE  VIEW ONLINE 



20 x 60 · 35 x 100  8 mm

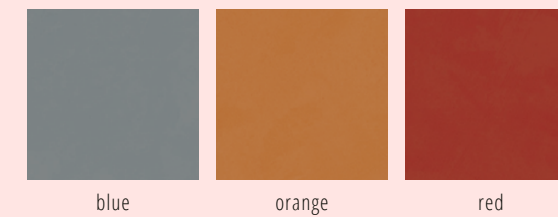
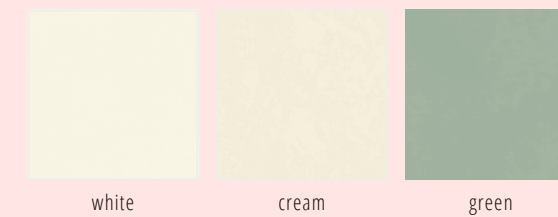

V1



60 x 60  8 mm



Index ▾

Colour Map ▾

Collections ▾

- Arise
- Avenue
- Balance
- Canyon
- Core
- Genesis
- Gravity
- Ground
- Light
- Marble
- Mémorable
- Metallic
- Native
- Nest
- Precious
- Pulse
- Sense
- Splash**
- Timber
- Urban
- Wooden

Technical Specifications ▾

Splash

Collection



Splash

Collection

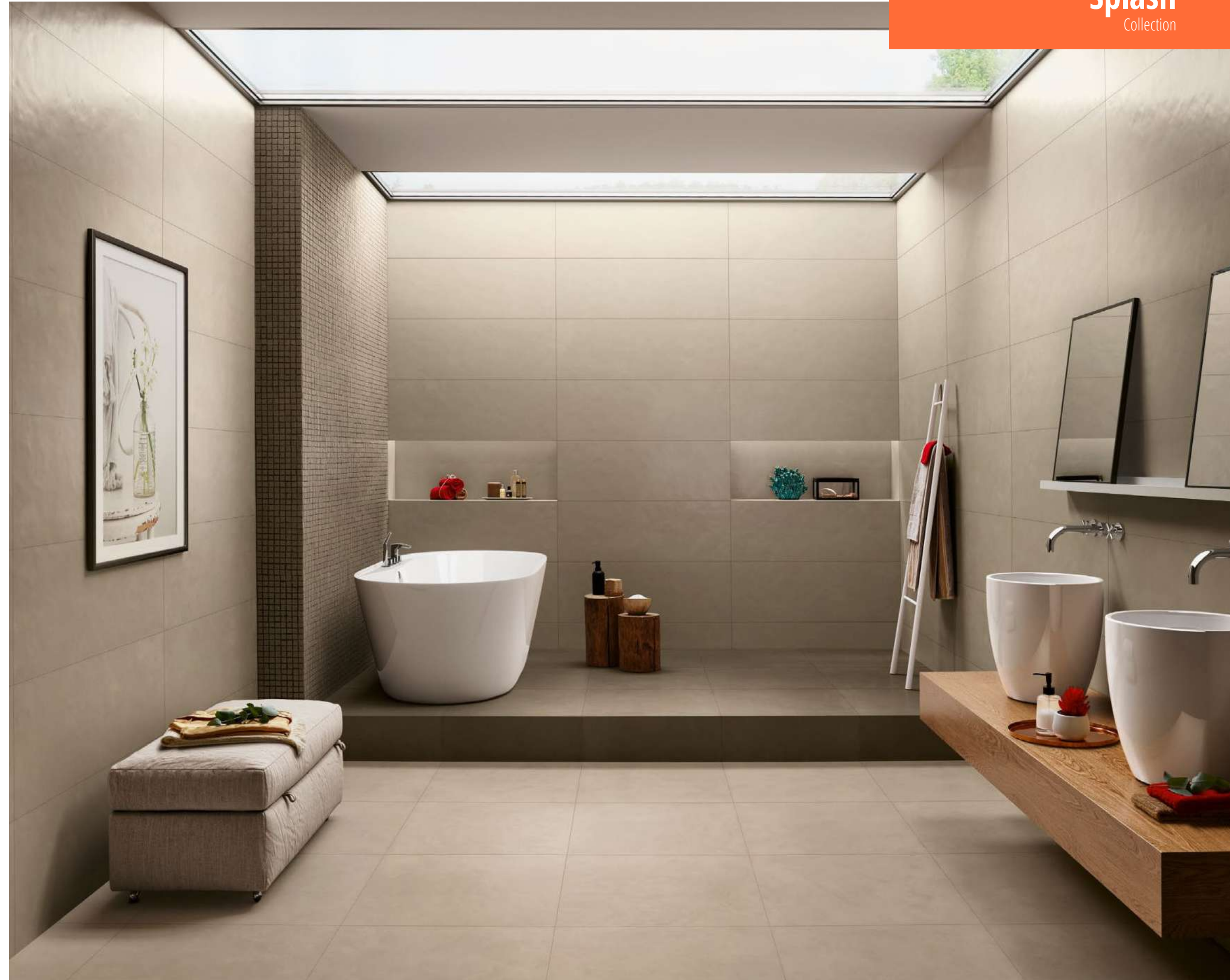

Index ▾

Colour Map ▾

Collections ▾

- Arise
- Avenue
- Balance
- Canyon
- Core
- Genesis
- Gravity
- Ground
- Light
- Marble
- Mémorable
- Metallic
- Native
- Nest
- Precious
- Pulse
- Sense
- Splash**
- Timber
- Urban
- Wooden

Technical Specifications ▾

LOVE
CERAMIC TILES

Splash Grey
35 x 100 Ret.

Mosaic Splash Tortora
20 x 20

Splash Tortora
60 x 60 Ret.

Splash Grey
60 x 60 Ret.

Splash

Collection



Splash

Collection



Index ▾

Colour Map ▾

Collections ▾

- Arise
- Avenue
- Balance
- Canyon
- Core
- Genesis
- Gravity
- Ground
- Light
- Marble
- Mémorable
- Metallic
- Native
- Nest
- Precious
- Pulse
- Sense
- Splash**
- Timber
- Urban
- Wooden

Technical Specifications ▾

LOVE
CERAMIC TILES

Splash Anthracite
35 x 100 Ret.

Mosaic Reactive Red
20 x 20

Splash Red
35 x 100 Ret.

Splash

Collection



Splash

Collection

Index ▼

Colour Map ▼

Collections ▼

- Arise
- Avenue
- Balance
- Canyon
- Core
- Genesis
- Gravity
- Ground
- Light
- Marble
- Mémorable
- Metallic
- Native
- Nest
- Precious
- Pulse
- Sense
- Splash**
- Timber
- Urban
- Wooden

Technical Specifications ▼

LOVE
CERAMIC TILES

Splash Orange
35 x 100 Ret.

Mosaic Splash Orange
20 x 20

Splash Anthracite
35 x 100 Ret.

Splash Cream
60 x 60 Ret.

Splash

Collection



Splash

Collection

Index ▼

Colour Map ▼

Collections ▼

- Arise
- Avenue
- Balance
- Canyon
- Core
- Genesis
- Gravity
- Ground
- Light
- Marble
- Mémorable
- Metallic
- Native
- Nest
- Precious
- Pulse
- Sense
- Splash**
- Timber
- Urban
- Wooden

LOVE
CERAMIC TILES

Patchwork Blue
20 x 60

Splash White
20 x 60

Splash Blue
20 x 60

Technical Specifications ▼

Splash

Collection



Splash

Collection

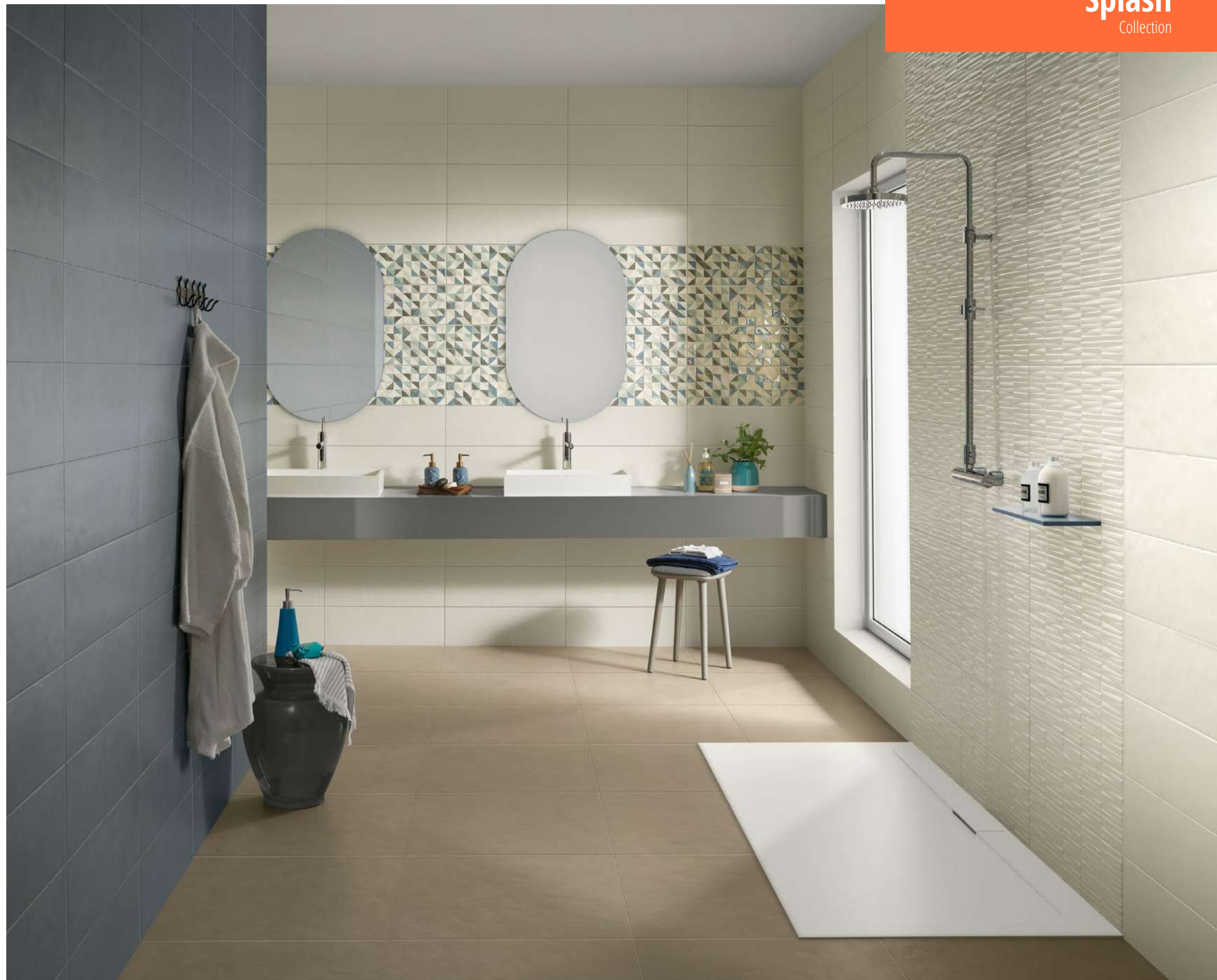

Index ▾

Colour Map ▾

Collections ▾

- Arise
- Avenue
- Balance
- Canyon
- Core
- Genesis
- Gravity
- Ground
- Light
- Marble
- Mémorable
- Metallic
- Native
- Nest
- Precious
- Pulse
- Sense
- Splash**
- Timber
- Urban
- Wooden

Technical Specifications ▾

LOVE
CERAMIC TILES

Splash Blue
20 x 60

Splash White
20 x 60

Coat Green
20 x 60

Freefall White
20 x 60

Splash Grey
61 x 61



8 mm

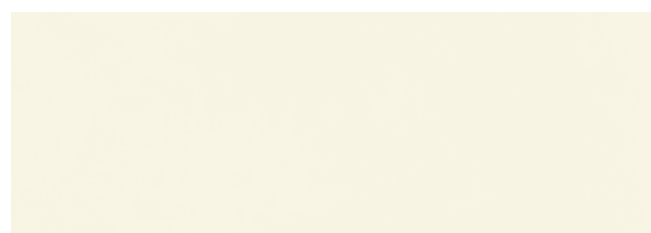

SPLASH WHITE
35x100 Ret. **LT-8075**
20x60 **LT-5590**

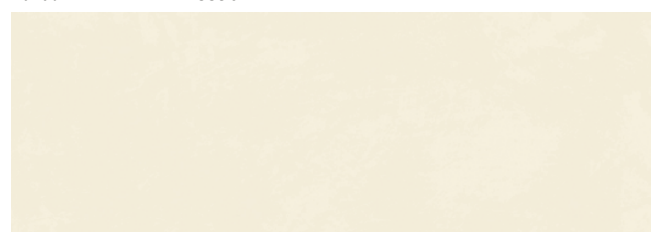

SPLASH CREAM
35x100 Ret. **LT-8075**
20x60 **LT-5590**



SPLASH GREY
35x100 Ret. **LT-8075**
20x60 **LT-5590**

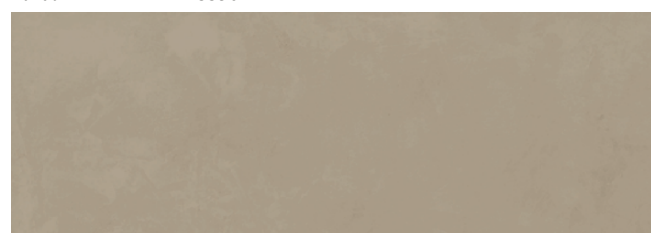

SPLASH TORTORA
35x100 Ret. **LT-8075**
20x60 **LT-5590**

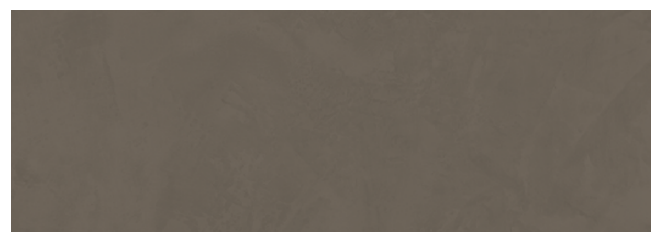

SPLASH ANTHRACITE
35x100 Ret. **LT-8075**
20x60 **LT-5590**



SPLASH GREEN
35x100 Ret. **LT-8270**
20x60 **LT-5890**

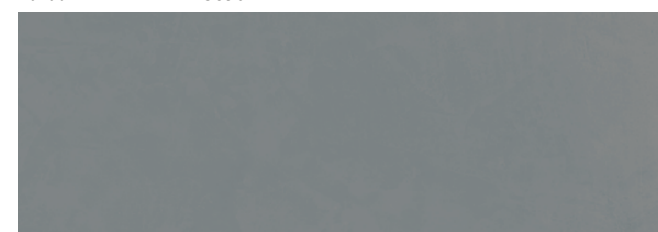

SPLASH BLUE
35x100 Ret. **LT-8270**
20x60 **LT-5890**



SPLASH ORANGE
35x100 Ret. **LT-8405**
20x60 **LT-5930**

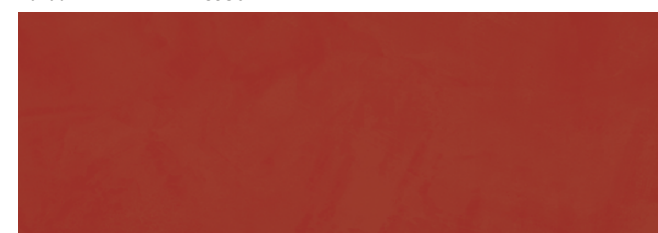

SPLASH RED
35x100 Ret. **LT-8405**
20x60 **LT-5930**



CANTO SPLASH
3x100 **LP-6410**
2,5x35 **LP-6270**



8 mm



SPLASH CREAM
61x61 **LT-2150**
60x60 Ret. **LT-2425**



SPLASH GREY
61x61 **LT-2150**
60x60 Ret. **LT-2425**

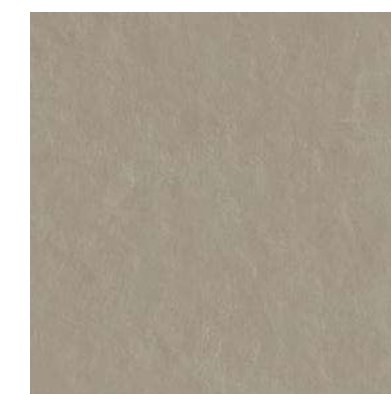

SPLASH TORTORA
61x61 **LT-2150**
60x60 Ret. **LT-2425**

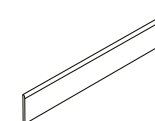

RODAPÉ SPLASH
8x61 **LP-6075**
8x60 Ret. **LP-6075**

- Arise
- Avenue
- Balance
- Canyon
- Core
- Genesis
- Gravity
- Ground
- Light
- Marble
- Mémorable
- Metallic
- Native
- Nest
- Precious
- Pulse
- Sense
- Splash**
- Timber
- Urban
- Wooden



8,5 - 10 mm

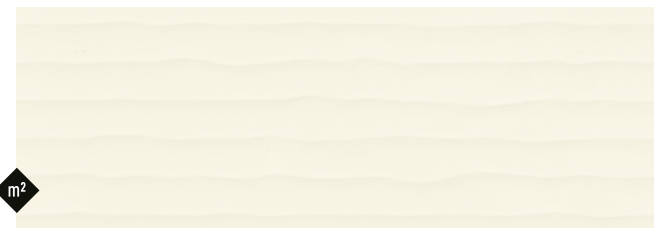

WATERFALL WHITE
35x100 Ret. LT-8405



WATERFALL GREEN
35x100 Ret. LT-8440



WATERFALL BLUE
35x100 Ret. LT-8440



WATERFALL ORANGE
35x100 Ret. LT-8470



WATERFALL RED
35x100 Ret. LT-8470

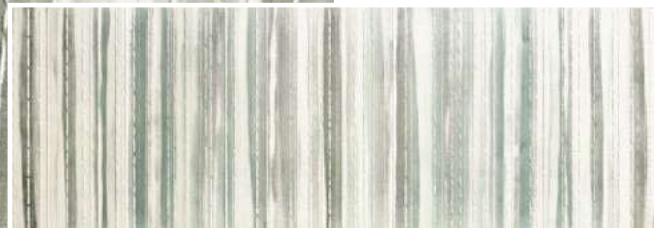

OVERLAY GREEN
35x100 Ret. LP-6510



OVERLAY RED
35x100 Ret. LP-6510



LOOP BLUE
35x100 Ret. LT-8405

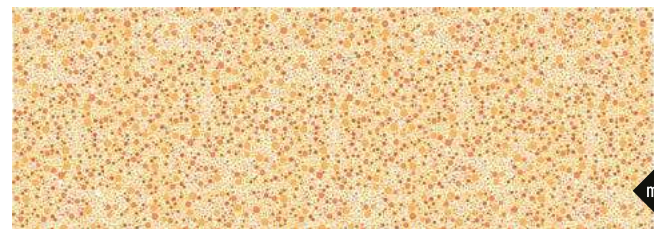

LOOP ORANGE
35x100 Ret. LT-8405



8 mm



BEATS CREAM
35x100 Ret. LT-8405



BEATS GREY
35x100 Ret. LT-8405



BEATS TORTORA
35x100 Ret. LT-8405

- Arise
- Avenue
- Balance
- Canyon
- Core
- Genesis
- Gravity
- Ground
- Light
- Marble
- Mémorable
- Metallic
- Native
- Nest
- Precious
- Pulse
- Sense
- Splash**
- Timber
- Urban
- Wooden



8 - 10 mm



SLIDE WHITE
20x60 LT-5950



FREEFALL WHITE
20x60 LT-5950



SLIDE ORANGE
20x60 LT-6020



FREEFALL GREEN
20x60 LT-5990



SLIDE ANTHRACITE
20x60 LT-5950



FREEFALL BLUE
20x60 LT-5990



FREEFALL ORANGE
20x60 LT-6020



FREEFALL RED
20x60 LT-6020



PATCHWORK BLUE
20x60 LT-5950



PATCHWORK MIX
20x60 LT-5950



PATCHWORK ANTHRACITE
20x60 LT-5950



COAT RED
20x60 LP-6300



LOOP MIX
20x60 LT-5950

8 mm



- Arise
- Avenue
- Balance
- Canyon
- Core
- Genesis
- Gravity
- Ground
- Light
- Marble
- Mémorable
- Metallic
- Native
- Nest
- Precious
- Pulse
- Sense
- Splash**
- Timber
- Urban
- Wooden



8 mm

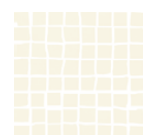

MOSAIC SPLASH WHITE
20x20 LP-6200

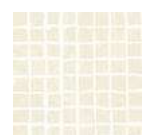

MOSAIC SPLASH CREAM
20x20 LP-6200



MOSAIC SPLASH GREY
20x20 LP-6200

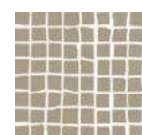

MOSAIC SPLASH TORTORA
20x20 LP-6200

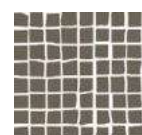

MOSAIC SPLASH ANTHRACITE
20x20 LP-6200

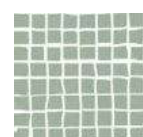

MOSAIC SPLASH GREEN
20x20 LP-6200

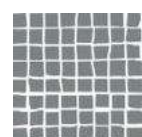

MOSAIC SPLASH BLUE
20x20 LP-6200

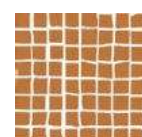

MOSAIC SPLASH ORANGE
20x20 LP-6200

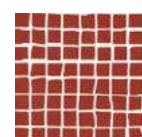

MOSAIC SPLASH RED
20x20 LP-6200



MOSAIC REACTIVE GREEN
20x20 LP-6260



MOSAIC REACTIVE BLUE
20x20 LP-6260



MOSAIC REACTIVE RED
20x20 LP-6260



8 mm

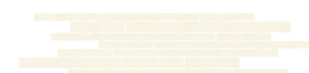

BRICKS SPLASH WHITE
10,5x35 STOCK OFF LP-6140

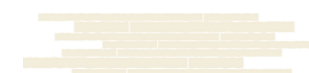

BRICKS SPLASH CREAM
10,5x35 STOCK OFF LP-6140



BRICKS SPLASH GREY
10,5x35 STOCK OFF LP-6140



BRICKS SPLASH TORTORA
10,5x35 STOCK OFF LP-6140



MOSAIC EARTH CREAM
20x20 LP-6220



MOSAIC EARTH GREY
20x20 LP-6220



MOSAIC EARTH TORTORA
20x20 LP-6220



8 mm

Collections

- Arise
- Avenue
- Balance
- Canyon
- Core
- Genesis
- Gravity
- Ground
- Light
- Marble
- Mémorable
- Metallic
- Native
- Nest
- Precious
- Pulse
- Sense
- Splash**
- Timber
- Urban
- Wooden





Light Branco Brilho 45 x 120 Ret. Listelo Blink Brushed Bronze 0,5 x 120 Arise Beige 80 x 80 Ret.

Light Collection

VIEW ONLINE 



45 x 120  9,5 mm
 35 x 70 · 35 x 100  8 mm
 30 x 60  7 mm

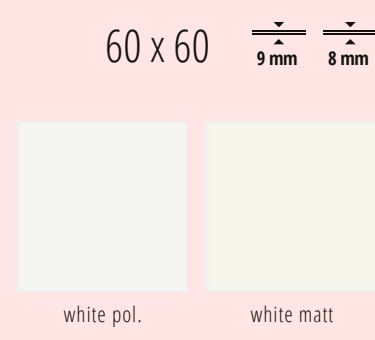
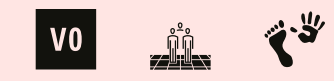
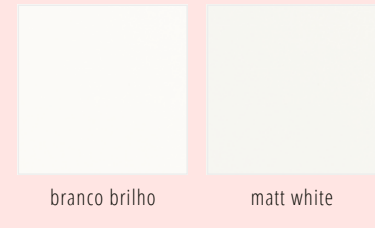

Index ▾

Colour Map ▾

Collections ▾

- Arise
- Avenue
- Balance
- Canyon
- Core
- Genesis
- Gravity
- Ground
- Light**
- Marble
- Mémorable
- Metallic
- Native
- Nest
- Precious
- Pulse
- Sense
- Splash
- Timber
- Urban
- Wooden

Technical Specifications ▾

Light

Collection



Light Matt White
35 x 100 Ret.

Genesis Rise White Matt
35 x 100 Ret.

Light

Collection



Light Branco Brilho
45 x 120 Ret.

Sense Grey
80 x 80 Ret. Touch

LOVE
CERAMIC TILES

Index ▾

Colour Map ▾

Collections ▾

- Arise
- Avenue
- Balance
- Canyon
- Core
- Genesis
- Gravity
- Ground
- Light**
- Marble
- Mémorable
- Metallic
- Native
- Nest
- Precious
- Pulse
- Sense
- Splash
- Timber
- Urban
- Wooden

Technical Specifications ▾



45x120 > 9,5 mm | 35x100 > 35x70 > 8 mm | 31x62 > 30x60 > 7 mm

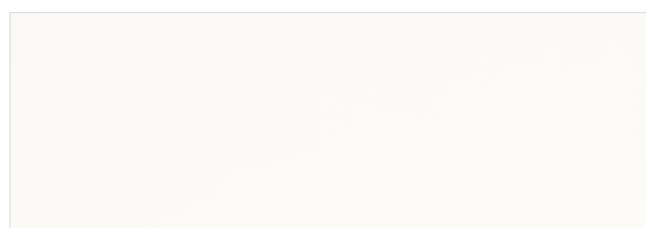

✕ LIGHT BRANCO BRILHO

45x120 Ret. **LT-8695**
35x100 Ret. **LT-8120**
35x70 Ret. **LT-7500**
31x62 **LT-6230**
30x60 Ret. **LT-6830**

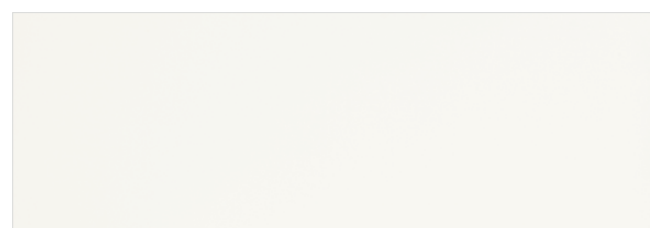

LIGHT MATT WHITE

45x120 Ret. **LT-8695**
35x100 Ret. **LT-8120**
35x70 Ret. **LT-7500**
31x62 **LT-6230**
30x60 Ret. **LT-6830**

27x28 > 27x27 > 12 mm



✕ MOSAICO GOLD MIX

27x27 (3,3x3,3) **STOCK OFF** LP-6470



✕ MOSAICO SILVER MIX

27x27 (3,3x3,3) **STOCK OFF** LP-6470



MOSAICO DECOR TREND

27x28 (3,3x6,9) **STOCK OFF** LP-6450



V0

9 mm

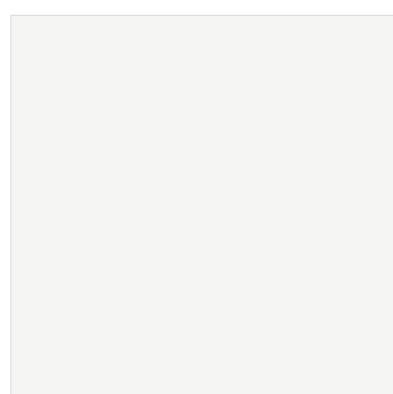

✕ LIGHT WHITE POL.

60x60 Ret. **LT-2780**

8 mm

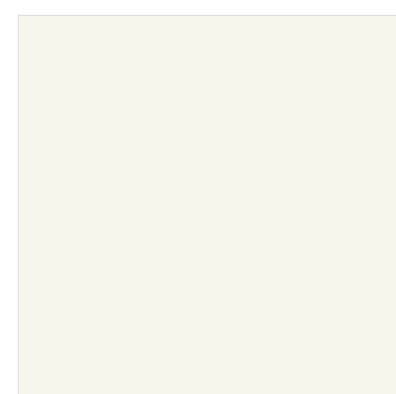

LIGHT WHITE MATT

60x60 Ret. **LT-2490**

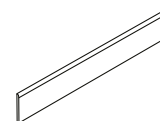

✕ RODAPÉ LIGHT WHITE POL.

8x60 Ret. **LP-6085**

RODAPÉ LIGHT WHITE MATT

8x60 Ret. **LP-6075**

Os produtos com acabamento polido são mais sensíveis à abrasão e às manchas. Por favor consulte a página 392 no capítulo 09.
Products with a polished finish are more sensitive to abrasion and stains. Please see page 392 in chapter 09.
Les produits à finition polie sont plus sensibles à l'abrasion et aux taches. Veuillez-vous consulter la page 392 du chapitre 09.
Produkte mit einer polierten Oberfläche sind empfindlicher gegen Abrieb und Fleckenbildung. Bitte beachten Sie Seite 392 in Kapitel 09.
Изделия с полированной поверхностью наиболее подвержены к истиранию и появлению пятен. Пожалуйста, посмотрите информацию на странице 392, в главе 09.
I prodotti con finitura lucida sono più sensibili all'abrasione e alle macchie. Si prega di fare riferimento alla pagina 392 del capitolo 09.

- Arise
- Avenue
- Balance
- Canyon
- Core
- Genesis
- Gravity
- Ground
- Light**
- Marble
- Mémorable
- Metallic
- Native
- Nest
- Precious
- Pulse
- Sense
- Splash
- Timber
- Urban
- Wooden



✕ PERFIL LIGHT BRILHO

1,7x50 **STOCK OFF** LP-6280
1,7x35 **STOCK OFF** LP-6220

PERFIL LIGHT MATT

1,7x50 **STOCK OFF** LP-6280
1,7x35 **STOCK OFF** LP-6220



✕ PERFIL LIGHT BRILHO

1,3x60 **LP-6330**
1,3x45 **LP-6310**
1,3x35 **LP-6220**

PERFIL LIGHT MATT

1,3x60 **LP-6330**
1,3x45 **LP-6310**
1,3x35 **LP-6220**

LISTELO BRUSHED GOLD

0,5x1,1x100 **LP-6420**
0,5x1,1x70 **LP-6370**
0,5x0,9x60 **LP-6340**



Listelo Brushed
Listelo Shine



LISTELO BRUSHED SILVER

0,5x1,1x100 **LP-6348**
0,5x1,1x70 **LP-6310**
0,5x0,9x60 **LP-6280**

LISTELO SHINE SILVER ✕

0,5x1,1x100 **LP-6348**
0,5x1,1x70 **LP-6310**
0,5x0,9x60 **LP-6280**

LISTELO BRUSHED BRONZE

0,5x1,1x100 **LP-6420**
0,5x1,1x70 **LP-6370**
0,5x0,9x60 **LP-6340**

BARRA INOX BRILHO ✕

2x0,8x100 **LP-6348**

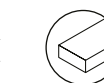

Barra Inox

BARRA INOX BRILHO ✕

1x0,8x100 **LP-6240**

LISTELO BLINK BRUSHED GOLD

0,5x1,2x120 **LP-6510**



Listelo Blink



LISTELO BLINK BRUSHED SILVER

0,5x1,2x120 **LP-6510**

LISTELO BLINK BRUSHED BRONZE

0,5x1,2x120 **LP-6510**



Gravity

Collection

DOWNLOAD CATALOGUE  VIEW ONLINE 

20 x 60 · 35 x 100  8 mm



Coloured Body
PORCELAIN

UGL   

80 x 80  9 mm

60 x 60  8 mm



PROTECT
Antibacterial for Life.

LOVE
CERAMIC TILES

Gravity Oxid Green 35 x 100 Ret. Quantum Light Grey 35 x 100 Ret. Gravity Light Grey 80 x 80 Ret.

Index ▾

Colour Map ▾

Collections ▾

- Arise
- Avenue
- Balance
- Canyon
- Core
- Genesis
- Gravity**
- Ground
- Light
- Marble
- Mémorable
- Metallic
- Native
- Nest
- Precious
- Pulse
- Sense
- Splash
- Timber
- Urban
- Wooden

Technical Specifications ▾

Gravity

Collection



Gravity Light Grey 20 x 60 Momentum Light Grey 20 x 60 Gravity Oxid Green 20 x 60 Gravity Grey 60 x 60 Ret.



Gravity

Collection

LOVE
CERAMIC TILES

Gravity Oxid Green 35 x 100 Ret. Tropic 35 x 100 Ret. Gravity White 80 x 80 Ret.

Index ▼

Colour Map ▼

Collections ▼

- Arise
- Avenue
- Balance
- Canyon
- Core
- Genesis
- Gravity**
- Ground
- Light
- Marble
- Mémorable
- Metallic
- Native
- Nest
- Precious
- Pulse
- Sense
- Splash
- Timber
- Urban
- Wooden

Technical Specifications ▼

Gravity

Collection

Gravity

Collection



Index ▾

Colour Map ▾

Collections ▾

- Arise
- Avenue
- Balance
- Canyon
- Core
- Genesis
- Gravity**
- Ground
- Light
- Marble
- Mémorable
- Metallic
- Native
- Nest
- Precious
- Pulse
- Sense
- Splash
- Timber
- Urban
- Wooden

Technical Specifications ▾

LOVE
CERAMIC TILES

Gravity White
35 x 100 Ret.

Rise Mix
35 x 100 Ret.

Native Tortora
20 x 100

Gravity

Collection



Gravity

Collection



Index ▾

Colour Map ▾

Collections ▾

- Arise
- Avenue
- Balance
- Canyon
- Core
- Genesis
- Gravity**
- Ground
- Light
- Marble
- Mémorable
- Metallic
- Native
- Nest
- Precious
- Pulse
- Sense
- Splash
- Timber
- Urban
- Wooden

LOVE
CERAMIC TILES

Gravity Light Grey
35 x 100 Ret.

Shadow Light Grey
35 x 100 Ret.

Gravity Grey
80 x 80 Ret.

Technical Specifications ▾

Gravity

Collection

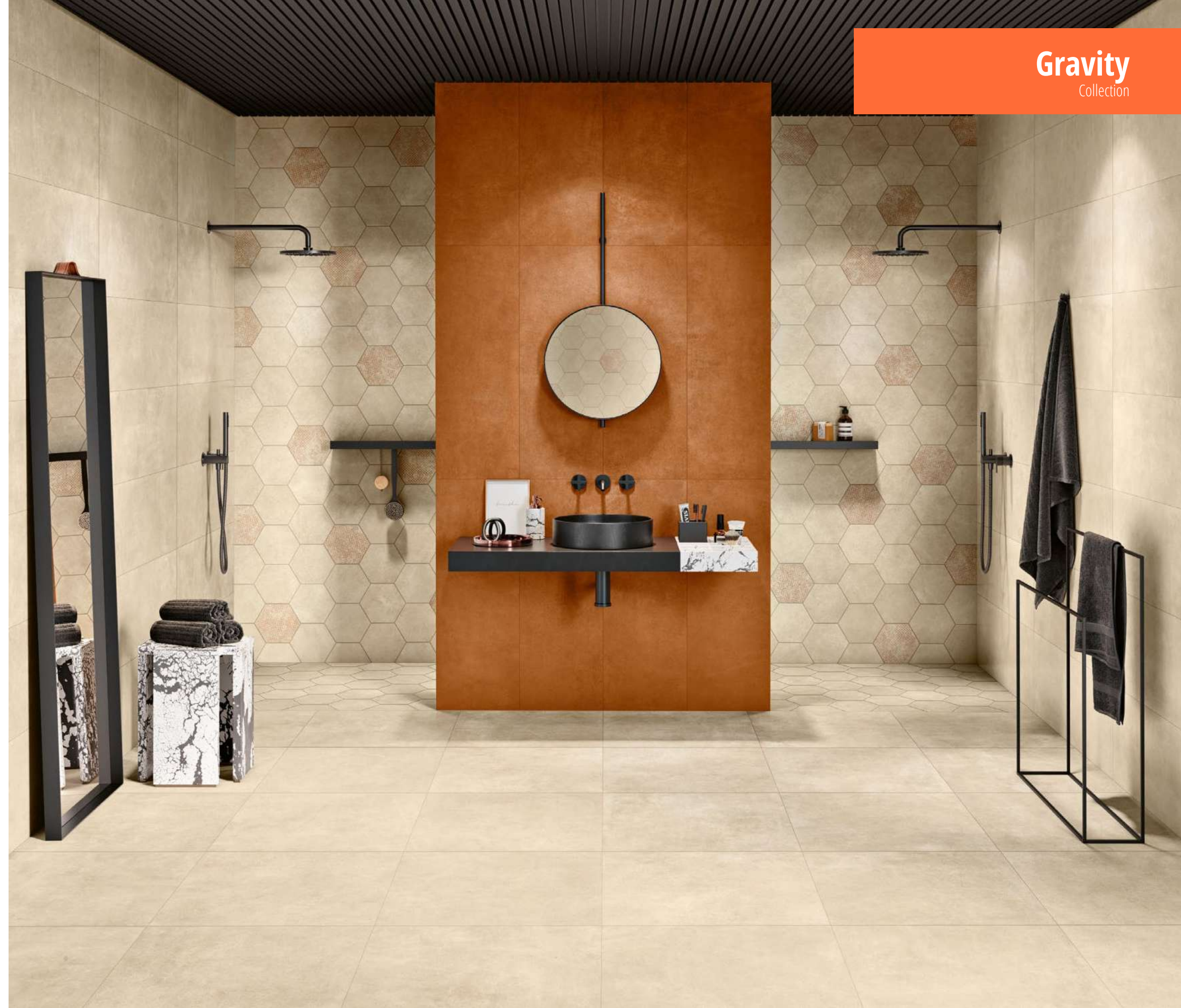

Gravity

Collection

Index ▾

Colour Map ▾

Collections ▾

- Arise
- Avenue
- Balance
- Canyon
- Core
- Genesis
- Gravity**
- Ground
- Light
- Marble
- Mémorable
- Metallic
- Native
- Nest
- Precious
- Pulse
- Sense
- Splash
- Timber
- Urban
- Wooden

LOVE
CERAMIC TILES

Gravity Beige
35 x 100 Ret.

Gravity Resin Orange
35 x 100 Ret.

Mosaic Cosmic Plus Beige
87 x 34

Mosaic Cosmic Beige
34 x 29

Gravity Beige
60 x 60 Ret.

Technical Specifications ▾

Gravity

Collection

Gravity

Collection



Index ▼

Colour Map ▼

Collections ▼

- Arise
- Avenue
- Balance
- Canyon
- Core
- Genesis
- Gravity**
- Ground
- Light
- Marble
- Mémorable
- Metallic
- Native
- Nest
- Precious
- Pulse
- Sense
- Splash
- Timber
- Urban
- Wooden

Technical Specifications ▼

LOVE
CERAMIC TILES

Mosaic Impetus Resin Orange
46 x 46

Gravity White
80 x 80 Ret.

Gravity

Collection

Gravity

Collection



Index ▾

Colour Map ▾

Collections ▾

- Arise
- Avenue
- Balance
- Canyon
- Core
- Genesis
- Gravity**
- Ground
- Light
- Marble
- Mémorable
- Metallic
- Native
- Nest
- Precious
- Pulse
- Sense
- Splash
- Timber
- Urban
- Wooden

Technical Specifications ▾



35x100 · 20x60 · 8 mm



GRAVITY WHITE
35x100 Ret. **LT-8050**
20x60 **LT-5590**



GRAVITY BEIGE
35x100 Ret. **LT-8050**
20x60 **LT-5590**



GRAVITY LIGHT GREY
35x100 Ret. **LT-8050**
20x60 **LT-5590**



GRAVITY OXID GREEN
35x100 Ret. **LT-8305**
20x60 **LT-5930**



GRAVITY RESIN ORANGE
35x100 Ret. **LT-8305**
20x60 **LT-5930**



Coloured Body
PORCELAIN

80x80 · 9 mm | 60x60 · 8 mm

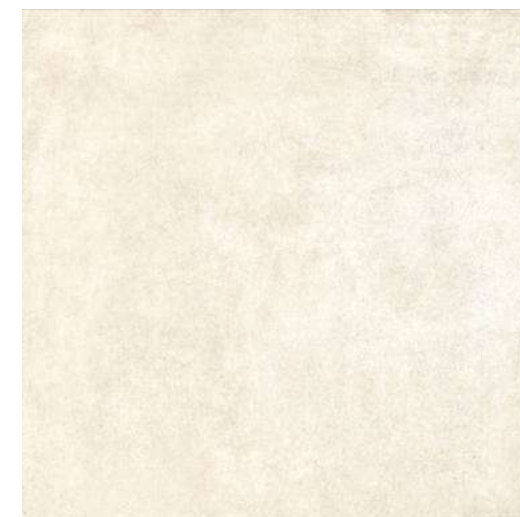

GRAVITY WHITE
80x80 Ret. **LT-2870**
60x60 Ret. **LT-2450**

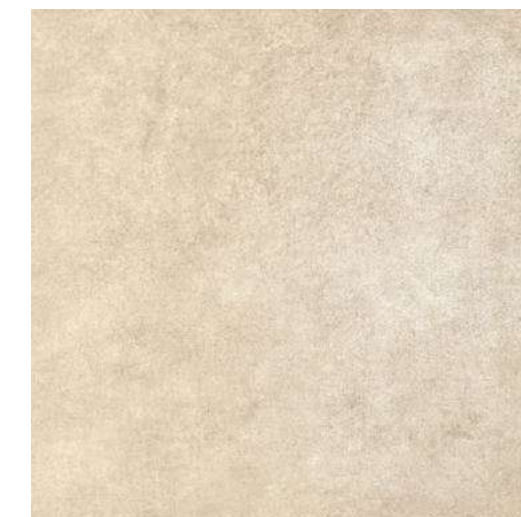

GRAVITY BEIGE
80x80 Ret. **LT-2870**
60x60 Ret. **LT-2450**

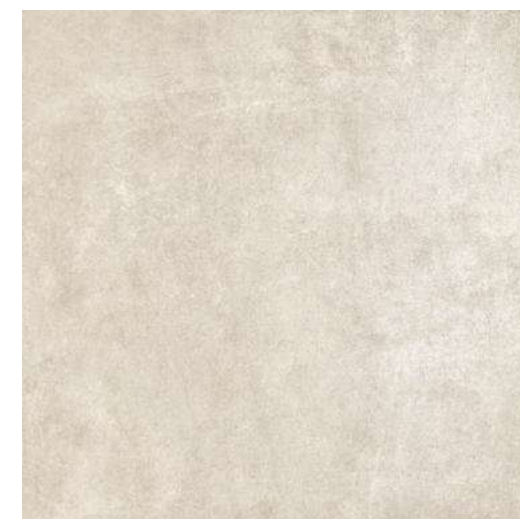

GRAVITY LIGHT GREY
80x80 Ret. **LT-2870**
60x60 Ret. **LT-2450**



GRAVITY GREY
80x80 Ret. **LT-2870**
60x60 Ret. **LT-2450**

PR()TECT®

Antibacterial for Life.

Uma linha exclusiva de pavimentos e revestimentos antimicrobianos de altíssima performance, projetada para ambientes saudáveis, seguros e protegidos. Por favor consulte a página 374.

An exclusive line of extremely high performance antimicrobial floor and wall tiles, designed for healthy, safe and protected living spaces. Please see page 374.

Une ligne exclusive de sols et revêtements antibactériens aux performances très élevées, pour un habitat sain, sûr et protégé. Veuillez-vous consulter la page 374.

Eine exklusive Linie an hochwertigen Fußböden und antibakteriellen Wandverkleidungen, für ein gesundes, sicheres und geschütztes Leben. Bitte beachten Sie Seite 374.

Эксклюзивная линия высокоэффективных противомикробных покрытий, предназначенных для здоровой, безопасной и защищенной окружающей среды. Пожалуйста, посмотрите информацию на странице 374.

Una linea esclusiva di pavimenti e rivestimenti antimicrobici ad altissime prestazioni, ideata per ambienti abitativi sani, sicuri e protetti. Si prega di fare riferimento alla pagina 374.

- Arise
- Avenue
- Balance
- Canyon
- Core
- Genesis
- Gravity**
- Ground
- Light
- Marble
- Mémorable
- Metallic
- Native
- Nest
- Precious
- Pulse
- Sense
- Splash
- Timber
- Urban
- Wooden



8 mm



SHADOW WHITE
35x100 Ret. **LT-8405**

10 - 10,6 mm



NET WHITE
35x100 Ret. **LT-8405**



SHADOW BEIGE
35x100 Ret. **LT-8405**



NET BEIGE
35x100 Ret. **LT-8405**



SHADOW LIGHT GREY
35x100 Ret. **LT-8405**



NET LIGHT GREY
35x100 Ret. **LT-8405**



Sugestão de aplicação.
Laying suggestion.
Suggestion de pose.
Anwendungsvorschlag.
Советы по укладке
Suggerimenti di posa

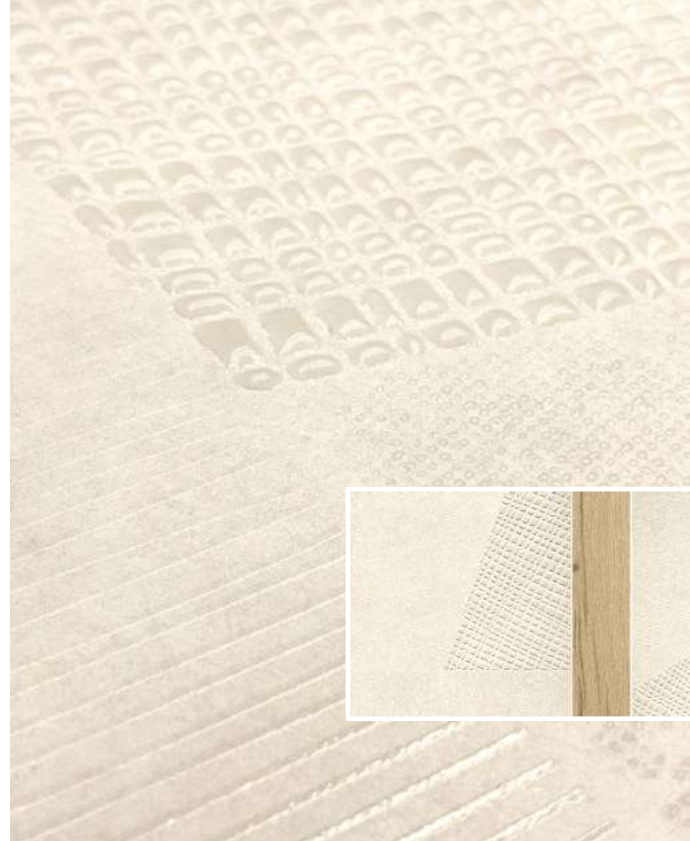
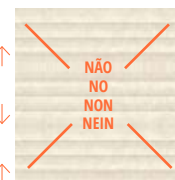

QUANTUM WHITE*
35x100 Ret. **LP-6510**



8 mm



ORBITAL WHITE
35x100 Ret. **LP-6460**



QUANTUM BEIGE**
35x100 Ret. **LP-6510**

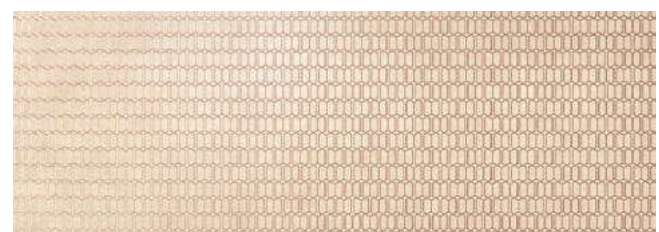

ORBITAL BEIGE
35x100 Ret. **LP-6460**

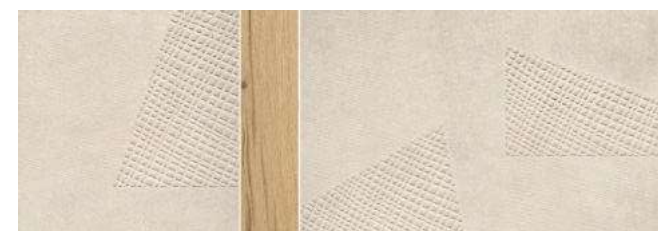

QUANTUM LIGHT GREY**
35x100 Ret. **LP-6510**



ORBITAL LIGHT GREY
35x100 Ret. **LP-6460**



Exemplo de composição das 3 peças.
Example of composition of the 3 pieces.
Exemple de composition des 3 pièces.
Beispiel für die Komposition der 3 Stück.
Пример композиции из 3 штук.
Esempio di composizione a 3 pz.

* Inseto de madeira: Native Light Beige
Wood insert: Native Light Beige
Insert Bois: Native Light Beige
Holzprofil eingefügt: Native Light Beige
Вставка из дерева: Native Light Beige
Insetto effetto legno: Native Light Beige

** Inseto de madeira: Native Dark Beige
Wood insert: Native Dark Beige
Insert Bois: Native Dark Beige
Holzprofil eingefügt: Native Dark Beige
Вставка из дерева: Native Dark Beige
Insetto effetto legno: Native Dark Beige

- Arise
- Avenue
- Balance
- Canyon
- Core
- Genesis
- Gravity**
- Ground
- Light
- Marble
- Mémorable
- Metallic
- Native
- Nest
- Precious
- Pulse
- Sense
- Splash
- Timber
- Urban
- Wooden



8,8 - 10,5 mm



RISE MIX
35x100 Ret. LT-8405

8 mm



TROPIC
35x100 Ret. LT-8405



Exemplo de composição das 6 peças. Os diferentes desenhos são embalados aleatoriamente.
 Example of composition of the 6 pieces. The available patterns are packed randomly.
 Exemple de composition des 6 pièces. Les différents motifs sont emballés aléatoirement.
 Beispiel für die Komposition der 6 Stück. Die verschiedenen Grafiken sind aleatorisch eingepackt.
 Пример композиции из 6 штук. Доступные дизайны упакованы в случайном порядке.
 Esempio di composizione a 6 pz. L'acquisto è a scatole con imballo misto.



8 mm



FRAME WHITE
20x60 LT-5950



FRAME BEIGE
20x60 LT-5950



FRAME LIGHT GREY
20x60 LT-5950



BAR WHITE
20x60 LT-5950



BAR BEIGE
20x60 LT-5950



BAR LIGHT GREY
20x60 LT-5950



MESH WHITE
20x60 LP-6260



MESH BEIGE
20x60 LP-6260



MESH LIGHT GREY
20x60 LP-6260



MOMENTUM WHITE
20x60 LP-6300



MOMENTUM BEIGE
20x60 LP-6300



MOMENTUM LIGHT GREY
20x60 LP-6300

- Arise
- Avenue
- Balance
- Canyon
- Core
- Genesis
- Gravity**
- Ground
- Light
- Marble
- Mémorable
- Metallic
- Native
- Nest
- Precious
- Pulse
- Sense
- Splash
- Timber
- Urban
- Wooden



8 mm



MOSAIC KINETIC WHITE
19x27 LP-6140



MOSAIC KINETIC BEIGE
19x27 LP-6140



MOSAIC KINETIC LIGHT GREY
19x27 LP-6140

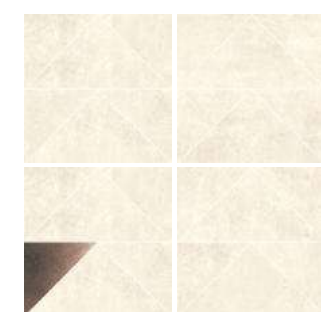

MOSAIC IMPETUS WHITE*
46x46 LP-6500

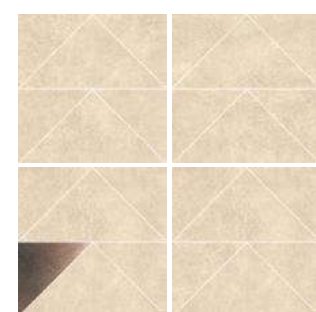

MOSAIC IMPETUS BEIGE*
46x46 LP-6500

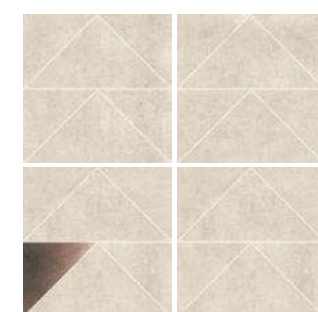

MOSAIC IMPETUS LIGHT GREY*
46x46 LP-6500

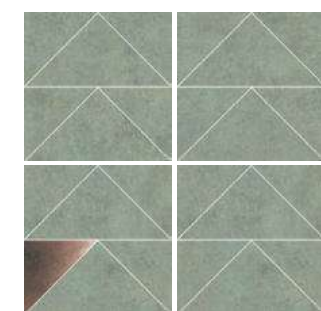

MOSAIC IMPETUS OXID GREEN*
46x46 LP-6500

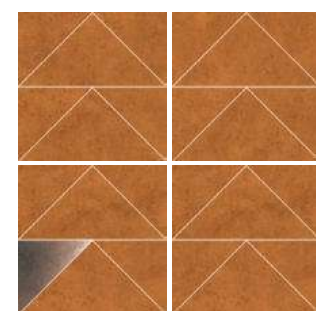

MOSAIC IMPETUS RESIN ORANGE*
46x46 LP-6500

* Vendida ao conjunto de 4 peças. Para informações sobre limpeza das decorações metálicas, por favor consulte o nosso website.
Sold as a set of 4 pieces. For further information on cleaning metallic decorations please see our website.
Vendu à l'ensemble de 4 pièces. Pour des informations concernant le nettoyage des décors métalliques veuillez consulter notre site internet.
Wird in der Kombination von 4 Teilen verkauft. Informationen zur Reinigung der Metalldekorationen finden Sie auf unserer Internetseite.
Продается комплектом из 4 штук. Для получения информации о чистке металлических декоров посетите наш веб-сайт.
Vendita a set di 4 pz. Per informazioni sulla pulizia delle decorazioni metallizzate per cortesia consultare nostro sito web.



8 mm

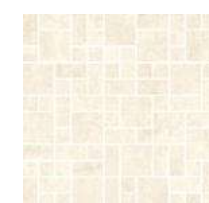

MOSAIC GRAVITY WHITE
30x30 LP-6270



MOSAIC GRAVITY BEIGE
30x30 LP-6270



MOSAIC GRAVITY LIGHT GREY
30x30 LP-6270



MOSAIC GRAVITY GREY
30x30 LP-6270

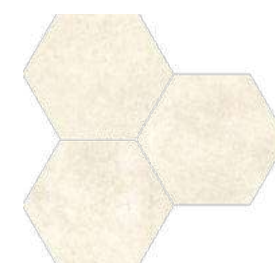

MOSAIC COSMIC WHITE
34x29 LP-6280

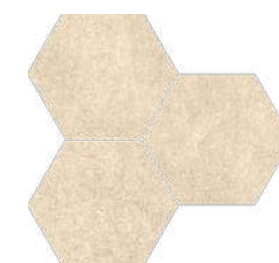

MOSAIC COSMIC BEIGE
34x29 LP-6280



MOSAIC COSMIC LIGHT GREY
34x29 LP-6280



MOSAIC COSMIC GREY
34x29 LP-6280



MOSAIC COSMIC PLUS WHITE*
87x34 LP-6510

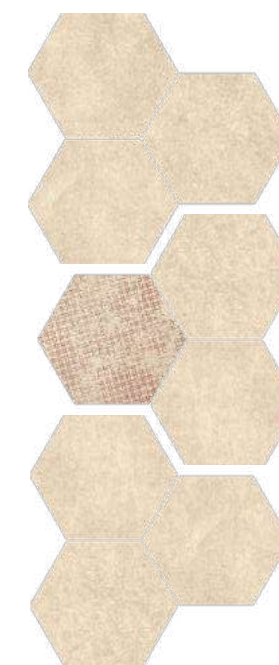

MOSAIC COSMIC PLUS BEIGE*
87x34 LP-6510

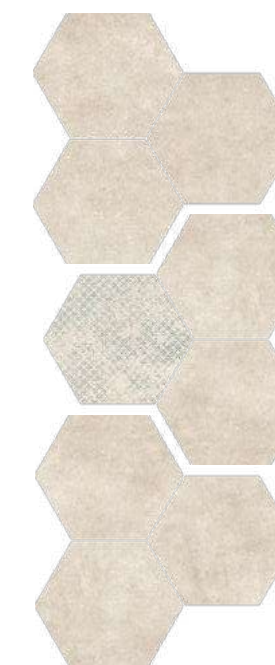

MOSAIC COSMIC PLUS LIGHT GREY*
87x34 LP-6510



MOSAIC COSMIC PLUS GREY*
87x34 LP-6510

* Vendida ao conjunto de 3 peças.
Sold as a set of 3 pieces.
Vendu à l'ensemble de 3 pièces.
Wird in der Kombination von 3 Teilen verkauft.
Продается комплектом из 3 штук.
Vendita a set di 3 pz.

- Arise
- Avenue
- Balance
- Canyon
- Core
- Genesis
- Gravity**
- Ground
- Light
- Marble
- Mémorable
- Metallic
- Native
- Nest
- Precious
- Pulse
- Sense
- Splash
- Timber
- Urban
- Wooden



30x80 · 8x80 · 9 mm | 30x60 · 8x60 · 8 mm

PEÇAS ESPECIAIS | SPECIAL PIECES | PIÈCES SPÉCIALES | SPEZIALTEILE | СПЕЦИАЛЬНЫЕ ИЗДЕЛИЯ | PEZZI SPECIALI

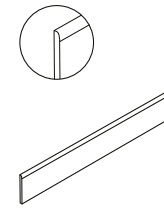

Rodapé Gravity
Skirting Gravity
Plinthe Gravity
Sockel Gravity
Плинтуса Gravity
Battiscopa Gravity

8x80 Ret. **LP-6130**
8x60 Ret. **LP-6075**

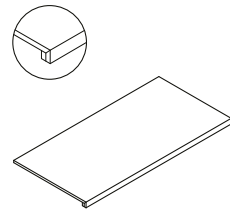

Degrau Espessurado
Step Extra Fluted
Nez De Marche Forte Épaisseur
Massive Stufenplatte
Ступень Утолщенная
Gradino Spessorato

30x80 Ret. **LP-6590**
30x60 Ret. **LP-6560**

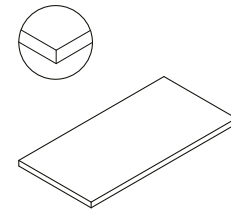

* Degrau Espessurado Canto
Step Extra Thick Corner
Nez De Marche Forte Épaisseur Angle
Ecke massive stufenplatte
Угловая ступень утолщенная
Angolo gradino spessorato

30x80 Ret. **LP-6670**
30x60 Ret. **LP-6630**

Degrau espessurado canto
Step extra thick corner
Nez de marche forte épaisseur angle
Ecke massive Stufenplatte
Угловая Ступень Утолщенная
Angolo Gradino Spessorato

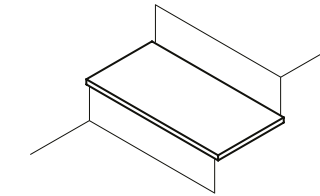

Canto direito
Right corner
Angle droit
Rechten ecke
Правый Угол
Angolo Destro

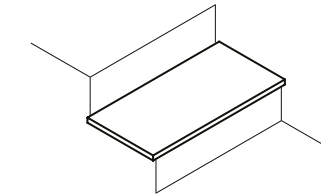

Canto esquerdo
Left corner
Angle gauche
Links ecke
Левый Угол
Angolo Sinistro

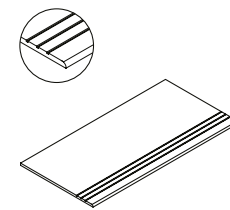

Degrau Sulcado
Step Tread Grooved
Nez De Marche Creusé
Stufenplatte Mit Rillen
Ступень С Насечками
Gradino Con Solchi

30x80 Ret. **LP-6490**
30x60 Ret. **LP-6350**

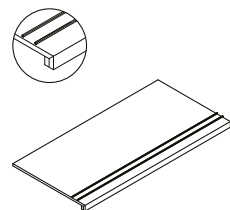

Degrau Espessurado Inox
Step Extra Thick Inox
Nez De Marche Forte Épaisseur Inox
Massive Stufenplatte Inox
Ступень Утолщенная С Металлическими Вставками
Gradino Spessorato Inox

30x80 Ret. **LP-6620**
30x60 Ret. **LP-6580**

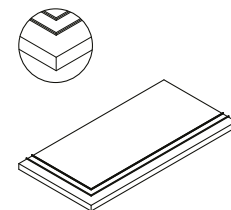
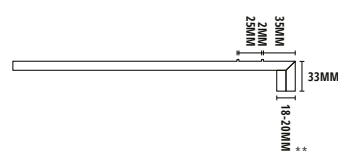

* Degrau Espessurado Canto Inox
Step Extra Thick Corner Inox
Nez De Marche Forte Épaisseur Angle Inox
Ecke massive stufenplatte inox
Угловая ступень утолщенная с металлическими вставками
Angolo gradino spessorato inox

30x80 Ret. **LP-6690**
30x60 Ret. **LP-6650**

Degrau espessurado canto inox
Step extra thick corner inox
Nez de marche forte épaisseur angle
Ecke massive Stufenplatte inox
Угловая Утолщенная Ступень С Металлическими Вставками
Angolo Gradino Spessorato Inox

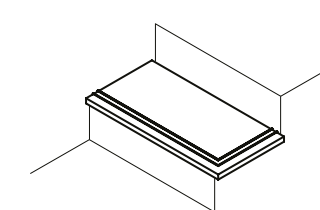

Canto direito
Right corner
Angle droit
Rechten ecke
Правый Угол
Angolo Destro

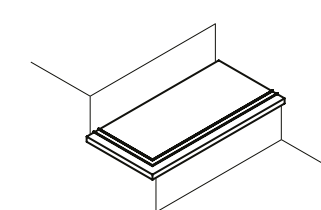

Canto esquerdo
Left corner
Angle gauche
Links ecke
Левый Угол
Angolo Sinistro

Disponível nas cores White, Beige, Light Grey e Grey.
Available in colours White, Beige, Light Grey and Grey.
Disponible dans les couleurs White, Beige, Light Grey et Grey.
Erhältlich in den Farben White, Beige, Light Grey und Grey.
Доступен в цветах White, Beige, Light Grey и Grey.
Disponibile nei colori White, Beige, Light Grey e Grey.

*Disponível no canto direito e esquerdo - Available in right and left corner - Disponible dans les coin droit et gauche
Erhältlich in der rechten Ecke und links - Доступна как правая так и левая угловая ступень - Disponibile nell'angolo destro e sinistro

**A dimensão varia consoante a espessura do material cerâmico - Dimension will vary depending on the base tile thickness - La dimension varie selon l'épaisseur du carreau
Das Maß variiert je nach Dicke der Fliese - Размер варьируется в зависимости от толщины керамического материала - La dimensione varia a seconda dello spessore della piastrella di base

Arise

Avenue

Balance

Canyon

Core

Genesis

Gravity

Ground

Light

Marble

Mémorable

Metallic

Native

Nest

Precious

Pulse

Sense

Splash

Timber

Urban

Wooden



Pulse White 20 x 60 Fuse 20 x 60 Pulse Greige 61 x 61

Pulse

Collection

DOWNLOAD CATALOGUE  VIEW ONLINE 



20 x 60  8 mm



60 x 60  8 mm



Index ▾

Colour Map ▾

Collections ▾

- Arise
- Avenue
- Balance
- Canyon
- Core
- Genesis
- Gravity
- Ground
- Light
- Marble
- Mémorable
- Metallic
- Native
- Nest
- Precious
- Pulse**
- Sense
- Splash
- Timber
- Urban
- Wooden

Technical Specifications ▾





Pulse Greige 20 x 60 Crop Plus Greige 20 x 60 Pulse Greige 60 x 60 Ret.



Pulse White 20 x 60 Canvas Blue 20 x 60 Pulse Greige 60 x 60 Ret.

- Arise
- Avenue
- Balance
- Canyon
- Core
- Genesis
- Gravity
- Ground
- Light
- Marble
- Mémorable
- Metallic
- Native
- Nest
- Precious
- Pulse**
- Sense
- Splash
- Timber
- Urban
- Wooden



Pulse White 20 x 60 Impulse 20 x 60 Pulse White 61 x 61

Collections ▾

- Arise
- Avenue
- Balance
- Canyon
- Core
- Genesis
- Gravity
- Ground
- Light
- Marble
- Mémorable
- Metallic
- Native
- Nest
- Precious
- Pulse**
- Sense
- Splash
- Timber
- Urban
- Wooden



Pulse Grey
20 x 60

Mosaic Pulse Greige
30 x 30

Pulse Grey
60 x 60 Ret.

Collections ▼

- Arise
- Avenue
- Balance
- Canyon
- Core
- Genesis
- Gravity
- Ground
- Light
- Marble
- Mémorable
- Metallic
- Native
- Nest
- Precious
- Pulse**
- Sense
- Splash
- Timber
- Urban
- Wooden



Collections ▾

- Arise
- Avenue
- Balance
- Canyon
- Core
- Genesis
- Gravity
- Ground
- Light
- Marble
- Mémorable
- Metallic
- Native
- Nest
- Precious
- Pulse**
- Sense
- Splash
- Timber
- Urban
- Wooden



8 mm



PULSE WHITE
20x60 LT-5570



PULSE GREIGE
20x60 LT-5570

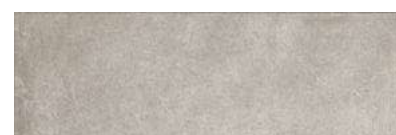

PULSE GREY
20x60 LT-5570

CROP PLUS · CROP > 9 mm



CROP PLUS WHITE
20x60 LT-5870



CROP WHITE
20x60 LT-5870



CROP PLUS GREIGE
20x60 LT-5870



CROP GREIGE
20x60 LT-5870



CROP PLUS GREY
20x60 LT-5870

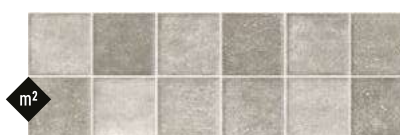

CROP GREY
20x60 LT-5870

IMPULSE > 9 mm | CANVAS · FUSE > 8 mm



IMPULSE
20x60 LT-5870



FUSE
20x60 LT-5870



CANVAS BLUE
20x60 LP-6280



CANVAS RED
20x60 LP-6280



V2

8 mm



PULSE WHITE
61x61 LT-2090
60x60 Ret. LT-2370



PULSE GREIGE
61x61 LT-2090
60x60 Ret. LT-2370

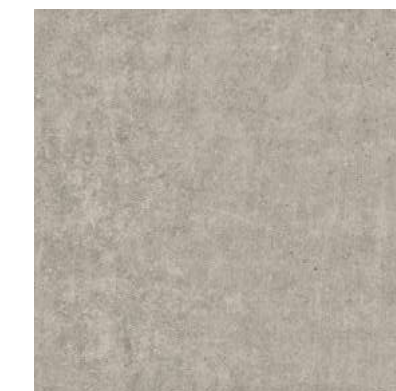

PULSE GREY
61x61 LT-2090
60x60 Ret. LT-2370

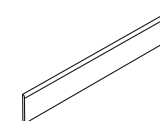

RODAPÉ PULSE
8x61 LP-6075
8x60 Ret. LP-6075



MOSAIC PULSE WHITE
30x30 (4,1x4,1) LP-6190



MOSAIC PULSE GREIGE
30x30 (4,1x4,1) LP-6190



MOSAIC PULSE GREY
30x30 (4,1x4,1) LP-6190



- Arise
- Avenue
- Balance
- Canyon
- Core
- Genesis
- Gravity
- Ground
- Light
- Marble
- Mémorable
- Metallic
- Native
- Nest
- Precious
- Pulse**
- Sense
- Splash
- Timber
- Urban
- Wooden



Ground Cream 20 x 60 Zero Cream 20 x 60 Homeland Cream 20 x 60 Ground Tortora 20 x 60 Mosaic Cream 20 x 20 Ground Tortora 61 x 61

Ground

Collection

DOWNLOAD CATALOGUE VIEW ONLINE



20 x 60 8 mm

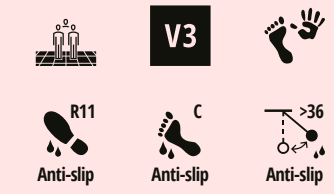

60 x 60 · 60 x 90 20 mm

60 x 60 8 mm



Index ▾

Colour Map ▾

Collections ▾

- Arise
- Avenue
- Balance
- Canyon
- Core
- Genesis
- Gravity
- Ground**
- Light
- Marble
- Mémorable
- Metallic
- Native
- Nest
- Precious
- Pulse
- Sense
- Splash
- Timber
- Urban
- Wooden

Technical Specifications ▾

Ground

Collection

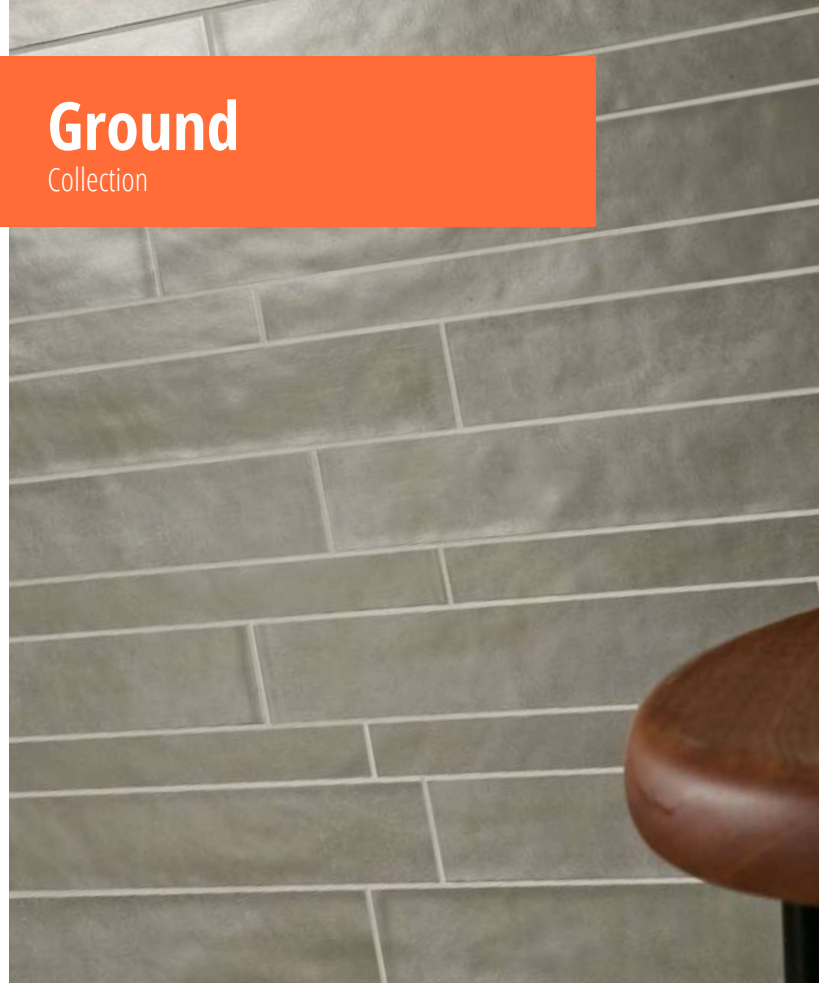

Ground

Collection



Index ▾

Colour Map ▾

Collections ▾

- Arise
- Avenue
- Balance
- Canyon
- Core
- Genesis
- Gravity
- Ground**
- Light
- Marble
- Mémorable
- Metallic
- Native
- Nest
- Precious
- Pulse
- Sense
- Splash
- Timber
- Urban
- Wooden

Technical Specifications ▾



Ground Light Grey 20 x 60 Globe Light Grey 20 x 60 Zone Light Grey 20 x 60 Ground Grey 20 x 60 Ribbon Grey 19 x 59 Ground Grey 61 x 61

Ground

Collection

Ground

Collection



Index ▼

Colour Map ▼

Collections ▼

- Arise
- Avenue
- Balance
- Canyon
- Core
- Genesis
- Gravity
- Ground**
- Light
- Marble
- Mémorable
- Metallic
- Native
- Nest
- Precious
- Pulse
- Sense
- Splash
- Timber
- Urban
- Wooden

Technical Specifications ▼

Ground

Collection

Ground

Collection



Index ▼

Colour Map ▼

Collections ▼

- Arise
- Avenue
- Balance
- Canyon
- Core
- Genesis
- Gravity
- Ground**
- Light
- Marble
- Mémorable
- Metallic
- Native
- Nest
- Precious
- Pulse
- Sense
- Splash
- Timber
- Urban
- Wooden

Technical Specifications ▼

Ground

Collection



Ground

Collection



[Index](#) ▼

[Colour Map](#) ▼

Collections

- Arise
- Avenue
- Balance
- Canyon
- Core
- Genesis
- Gravity
- Ground**
- Light
- Marble
- Mémorable
- Metallic
- Native
- Nest
- Precious
- Pulse
- Sense
- Splash
- Timber
- Urban
- Wooden

[Technical Specifications](#) ▼

LOVE
CERAMIC TILES

Ground 20mm Grey
60 x 60 AS



8 mm



GROUND WHITE
20x60 LT-5590



GROUND CREAM
20x60 LT-5590

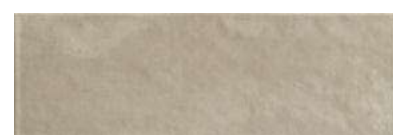

GROUND TORTORA
20x60 LT-5590



61x61 - 60x60 > 8 mm

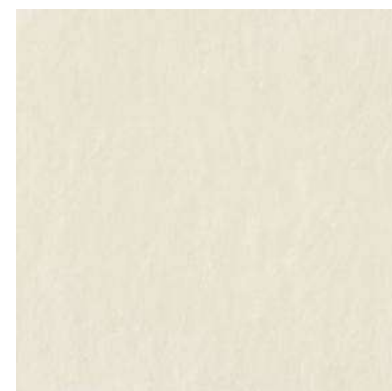

GROUND WHITE
61x61 LT-2150
60x60 Ret. LT-2425



GROUND CREAM
61x61 LT-2150
60x60 Ret. LT-2425



GROUND TORTORA
61x61 LT-2150
60x60 Ret. LT-2425



61x61 - 60x60 > 8 mm



GROUND LIGHT GREY
61x61 LT-2150
60x60 Ret. LT-2425

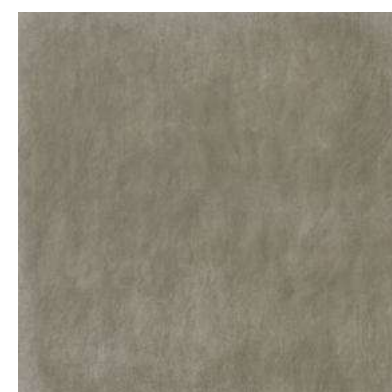

GROUND GREY
61x61 LT-2150
60x60 Ret. LT-2425

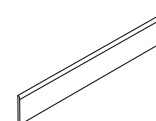

RODAPÉ GROUND
8x61 LP-6075
8x60 Ret. LP-6075



8 mm



GROUND LIGHT GREY
20x60 LT-5590



GROUND GREY
20x60 LT-5590

- Arise
- Avenue
- Balance
- Canyon
- Core
- Genesis
- Gravity
- Ground**
- Light
- Marble
- Mémorable
- Metallic
- Native
- Nest
- Precious
- Pulse
- Sense
- Splash
- Timber
- Urban
- Wooden



9 mm



ZERO WHITE
20x60 LT-5910



ZERO CREAM
20x60 LT-5910



ZERO TORTORA
20x60 LT-5910



ZERO LIGHT GREY
20x60 LT-5910



ZERO GREY
20x60 LT-5910



FORCE WHITE
20x60 LT-5910



FORCE CREAM
20x60 LT-5910



FORCE TORTORA
20x60 LT-5910



FORCE LIGHT GREY
20x60 LT-5910



FORCE GREY
20x60 LT-5910



9 mm



HOMELAND WHITE
20x60 LT-5910



HOMELAND CREAM
20x60 LT-5910



HOMELAND TORTORA
20x60 LT-5910



HOMELAND LIGHT GREY
20x60 LT-5910



HOMELAND GREY
20x60 LT-5910

HOMELAND*
Exemplo de composição com 12 peças.
Example of 12 pieces composition.
Exemple de composition avec 12 pièces.
Beispiel einer Komposition mit 12 Stücken.
Пример композиции из 12 штук.
Esempio di composizione con 12 pezzi.

*
Os diferentes desenhos são embalados aleatoriamente.
The available patterns are packed randomly.
Les différents motifs sont emballés aléatoirement.
Die verschiedenen Grafiken sind aleatorisch eingepackt.
Различные дизайны упакованы в случайном порядке.
I diversi motivi sono imballati in modo casuale.



8 mm



RIBBON WHITE
19x59 LP-6230



RIBBON CREAM
19x59 LP-6230



RIBBON TORTORA
19x59 LP-6230



RIBBON LIGHT GREY
19x59 LP-6230



RIBBON GREY
19x59 LP-6230

- Arise
- Avenue
- Balance
- Canyon
- Core
- Genesis
- Gravity
- Ground**
- Light
- Marble
- Mémorable
- Metallic
- Native
- Nest
- Precious
- Pulse
- Sense
- Splash
- Timber
- Urban
- Wooden

Ground

Collection



8 mm



ZONE WHITE
20x60 LP-6220



GLOBE WHITE
20x60 LP-6220



ROOTS WHITE
20x60 LP-6230



BARRA ZONE WHITE
5x60 LP-6120



ZONE CREAM
20x60 LP-6220



GLOBE CREAM
20x60 LP-6220

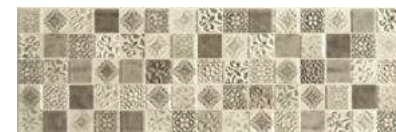

ROOTS CREAM
20x60 LP-6230



BARRA ZONE CREAM
5x60 LP-6120

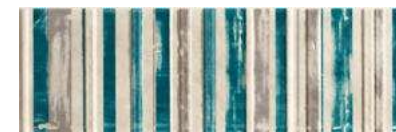

ZONE LIGHT GREY
20x60 LP-6220

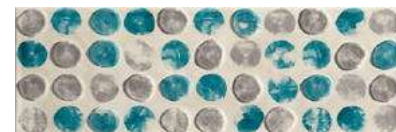

GLOBE LIGHT GREY
20x60 LP-6220



ROOTS LIGHT GREY
20x60 LP-6230



BARRA ZONE LIGHT GREY
5x60 LP-6120

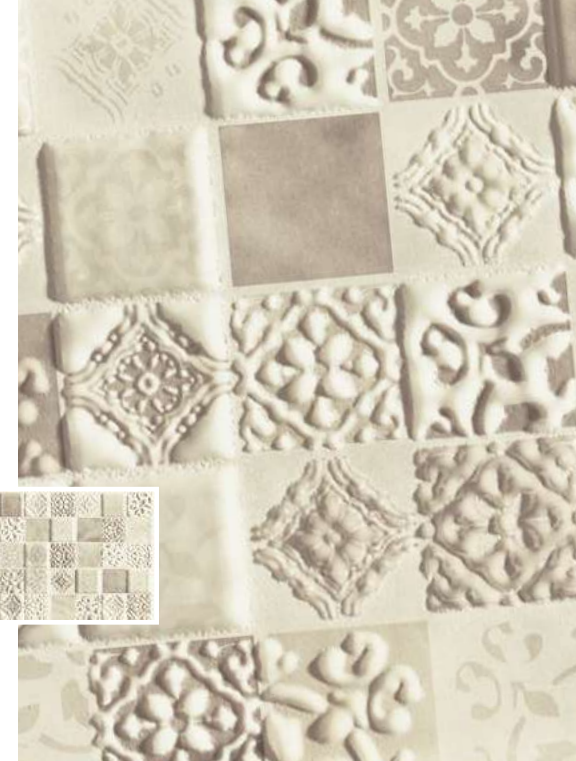

Ground

Collection



8 mm



MOSAIC GROUND WHITE
20x20 LP-6190



MOSAIC GROUND CREAM
20x20 LP-6190



MOSAIC GROUND TORTORA
20x20 LP-6190



MOSAIC GROUND LIGHT GREY
20x20 LP-6190



MOSAIC GROUND GREY
20x20 LP-6190



MOSAIC PLUS WHITE
20x20 LP-6220



MOSAIC PLUS CREAM
20x20 LP-6220



MOSAIC PLUS TORTORA
20x20 LP-6220



MOSAIC PLUS LIGHT GREY
20x20 LP-6220



MOSAIC PLUS GREY
20x20 LP-6220



Index

Colour Map

Collections

Arise

Avenue

Balance

Canyon

Core

Genesis

Gravity

Ground

Light

Marble

Mémorable

Metallic

Native

Nest

Precious

Pulse

Sense

Splash

Timber

Urban

Wooden

Technical Specifications



20 mm



GROUND 20MM CREAM

60x60 AS **LT-3570**
60x60 Ret. AS **LT-3600**



GROUND 20MM TORTORA

60x90 Ret. AS **LT-3800**
60x60 AS **LT-3570**
60x60 Ret. AS **LT-3600**



GROUND 20MM LIGHT GREY

60x90 Ret. AS **LT-3800**
60x60 AS **LT-3570**
60x60 Ret. AS **LT-3600**



GROUND 20MM GREY

60x90 Ret. AS **LT-3800**
60x60 AS **LT-3570**
60x60 Ret. AS **LT-3600**

OUTDOOR
EXTRA THICK

PEÇAS ESPECIAIS | SPECIAL PIECES | PIÈCES SPÉCIALES | SPEZIALTEILE | СПЕЦИАЛЬНЫЕ ИЗДЕЛИЯ | PEZZI SPECIALI



20 mm

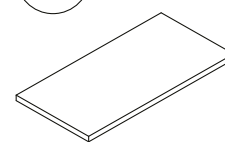

Base
Straight edge
Margelle
Stufenplatte
Ступень базовая
Gradino costa retta

30x60 20mm AS **LP-6340**
30x60 Ret. 20mm AS **LP-6435**

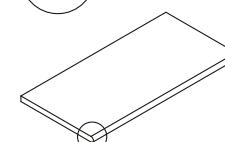

Base boleada
Bullnose
Margelle arrondie
Stufenplatte abgerundet
Ступень с закругленной фаской
Gradino costa toro

30x60 20mm AS **LP-6525**
30x60 Ret. 20mm AS **LP-6585**

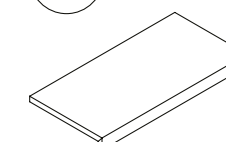

Degrau Espessurado 20mm
Step extra thick 20mm
Nez de marche forte épaisseur 20mm
Massive stufenplatte 20mm
Ступень утолщенная 20mm
Gradino spessorato 20mm

30x60 Ret. 20mm AS **LP-6590**
30x90 Ret. 20mm AS **LP-6630**

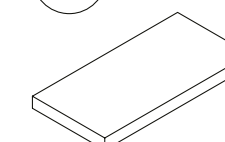

* Degrau Espessurado 20mm Canto
Step extra thick 20mm corner
Nez de marche forte épaisseur 20mm angle
Ecke massive stufenplatte 20mm
Угловая ступень утолщенная 20mm
Angolo gradino spessorato 20mm

30x60 Ret. 20mm AS **LP-6660**
30x90 Ret. 20mm AS **LP-6690**

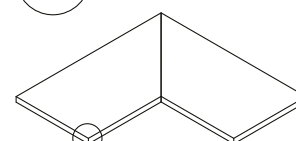

** Canto interior
Straight edge inner corner
Margelle angle bord droit intérieur
Eckstufe
Внутренний угол
Angolo interno

30x60 20mm AS **LP-6470**
30x60 Ret. 20mm AS **LP-6532**

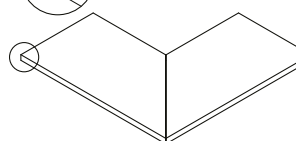

** Canto exterior
Straight edge outer corner
Margelle angle bord droit extérieur
Eckstufe Außenseite
Внешний угол
Angolo esterno

30x60 20mm AS **LP-6470**
30x60 Ret. 20mm AS **LP-6532**

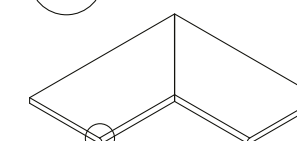

** Canto interior boleado
Bullnose inner corner
Margelle bord intérieur arrondi
Abgerundete Innenecke (Gärung)
Внутренний угол с фаской
Gradino con bordo interno a toro

30x60 20mm AS **LP-6660**
30x60 Ret. 20mm AS **LP-6720**

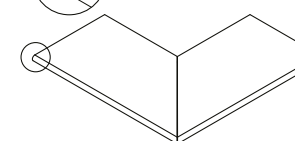

** Canto exterior boleado
Bullnose outer corner
Margelle bord extérieur arrondi
Abgerundete Aussenecke (Gärung)
Внешний угол с фаской
Gradino con bordo esterno a toro

30x60 20mm AS **LP-6660**
30x60 Ret. 20mm AS **LP-6720**

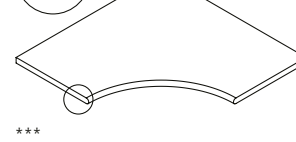

*** Canto interior redondo boleado
Internal corner bullnose
Margelle angle rentrant arrondi
Abgerundete Innenecke
Угол внутренний округлый с фаской
Gradino ad angolo rientrante con toro

60x60 20mm AS **LP-6690**
60x60 Ret. 20mm AS **LP-6690**

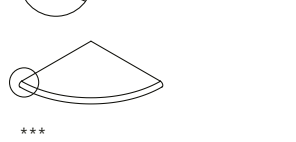

*** Canto exterior redondo boleado
External corner bullnose
Margelle angle sortant arrondi
Abgerundete Aussenecke
Угол внешний округлый с фаской
Gradino ad angolo sporgente con toro

30x30 20mm AS **LP-6590**
30x30 Ret. 20mm AS **LP-6590**

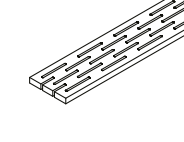

Grelha LT
Overflow grille LT
Grille LT
Überlauf LT
Решетка LT
Griglia LT

15x60 20mm AS **LP-6520**
15x60 Ret. 20mm AS **LP-6520**

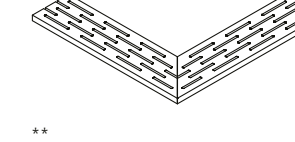

** Canto grelha LT
Overflow corner grille LT
Angle grille LT
Überlauf Ecke LT
Углы решетки LT
Griglia ad angolo LT

15x60 20mm AS **LP-6690**
15x60 Ret. 20mm AS **LP-6690**

* Disponível no canto direito e esquerdo - Available in right and left corner - Disponible dans les coin droit et gauche
Erhältlich in der rechten Ecke und links - Доступна как правая так и левая угловая ступень - Disponibile nell'angolo destro e sinistro

** Vendida ao par - Sold per two pieces set - Vendu à la paire
* Paarweise verkauft - Продаётся в комплекте состоящим из двух штук - Venduta a coppie

*** Raio - Radius - Rayon - Radius - Radius - Радиус: 30cm



Cube Blanc
30 x 60 Ret. Touch

Mémorable Blanc
60 x 60 Ret. Touch

Mémorable

Collection

VIEW VIDEO

DOWNLOAD CATALOGUE

VIEW ONLINE

Coloured Body
PORCELAIN

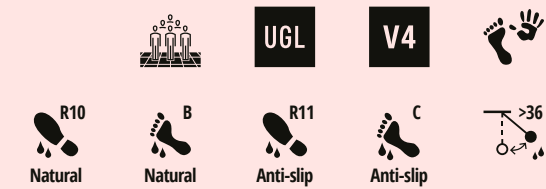

60 x 90
30 x 60 · 60 x 60 · 60 x 90



blanc taupe gris



pour plus d'informations, consultez
<https://evaluation.cstb.fr>

PROTECT

Antibacterial for Life.

LOVE
CERAMIC TILES

Index ▼

Colour Map ▼

Collections ▼

Arise

Avenue

Balance

Canyon

Core

Genesis

Gravity

Ground

Light

Marble

Mémorable

Metallic

Native

Nest

Precious

Pulse

Sense

Splash

Timber

Urban

Wooden

Technical Specifications ▼

Mémorable

Collection



Mémorable

Collection



Index ▼

Colour Map ▼

Collections ▼

Arise

Avenue

Balance

Canyon

Core

Genesis

Gravity

Ground

Light

Marble

Mémorable

Metallic

Native

Nest

Precious

Pulse

Sense

Splash

Timber

Urban

Wooden

Technical Specifications ▼

LOVE
CERAMIC TILES

Mémorable Blanc
60 x 90 Ret.

Mémorable

Collection



Mémorable

Collection



Index ▼

Colour Map ▼

Collections ▼

Arise

Avenue

Balance

Canyon

Core

Genesis

Gravity

Ground

Light

Marble

Mémorable

Metallic

Native

Nest

Precious

Pulse

Sense

Splash

Timber

Urban

Wooden

LOVE
CERAMIC TILES

Griffe Blanc
60 x 90 Ret.

Mémorable Blanc
60 x 90 Ret.

Mosaic Mémorable Gris
30 x 30 Touch

Mémorable Gris
60 x 60 Ret.

Technical Specifications ▼

Mémorable

Collection

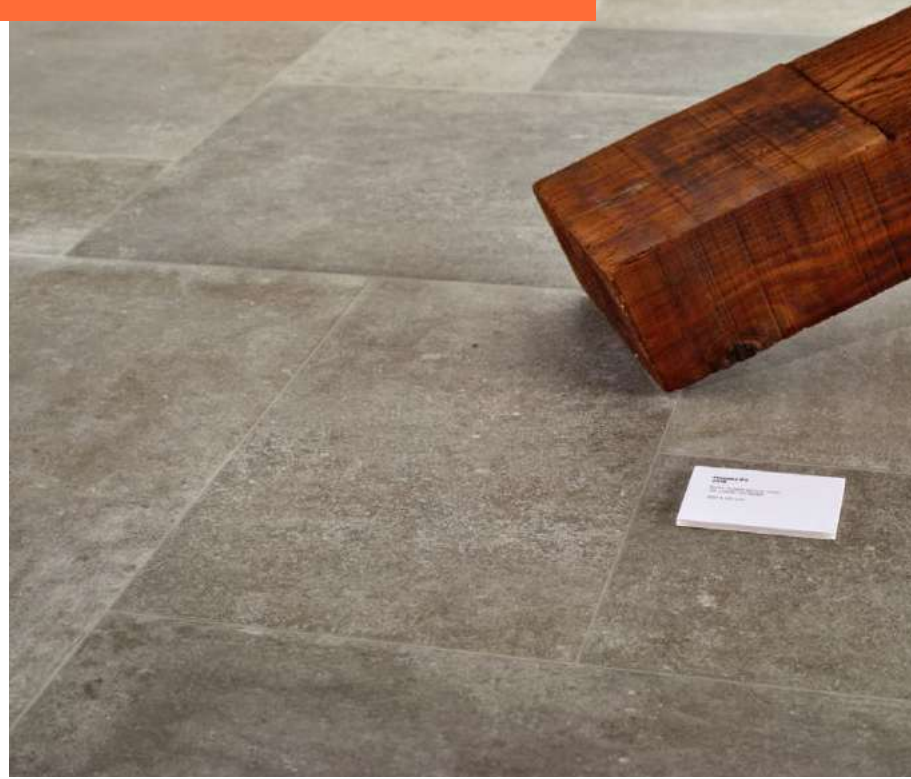

Mémorable

Collection

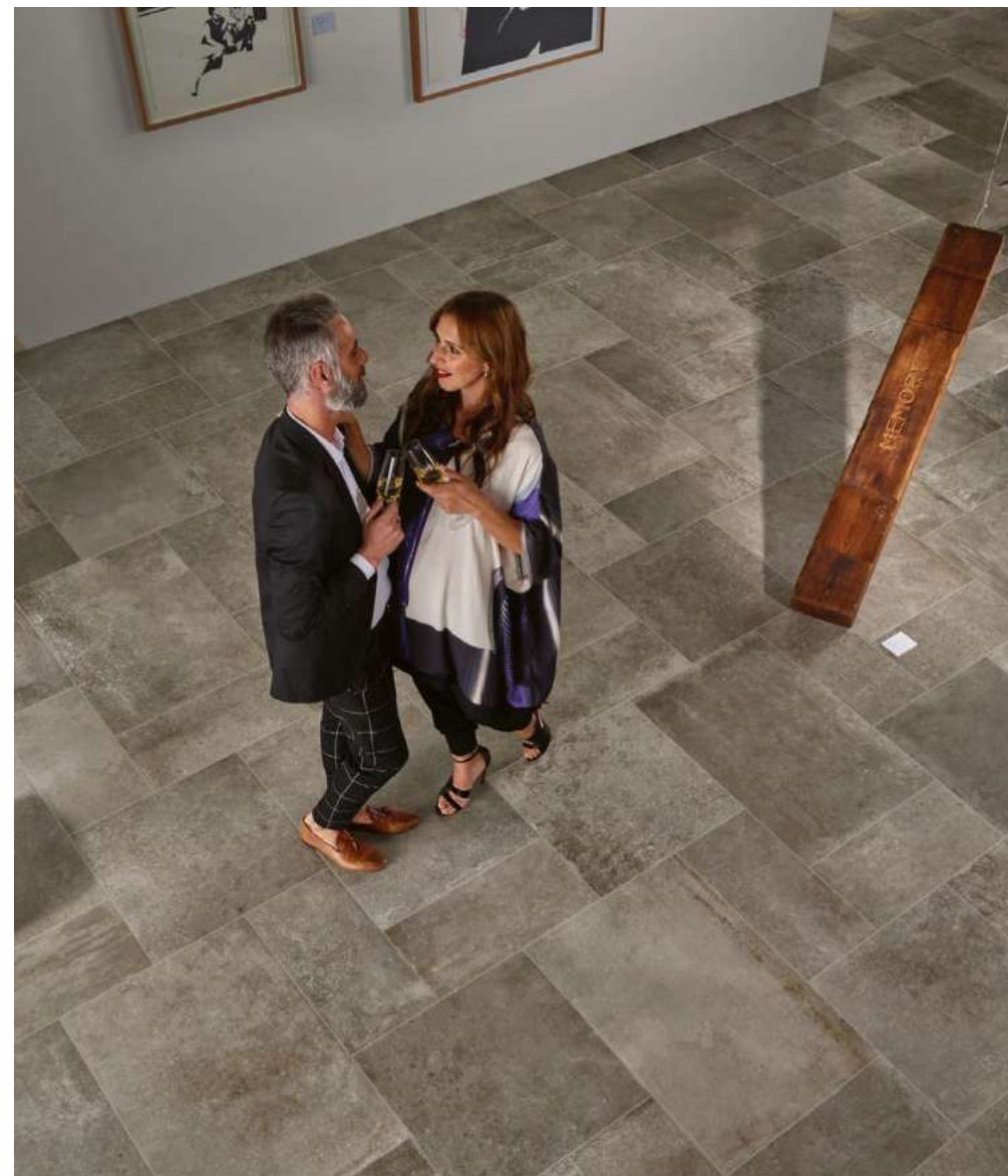

Index ▾

Colour Map ▾

Collections ▾

Arise

Avenue

Balance

Canyon

Core

Genesis

Gravity

Ground

Light

Marble

Mémorable

Metallic

Native

Nest

Precious

Pulse

Sense

Splash

Timber

Urban

Wooden

Technical Specifications ▾

Mémorable

Collection



Mémorable 20mm Gris
60 x 90 Ret. AS

Mémorable

Collection



Mémorable Taupe
Multiformato B AS

Index ▼

Colour Map ▼

Collections ▼

Arise

Avenue

Balance

Canyon

Core

Genesis

Gravity

Ground

Light

Marble

Mémorable

Metallic

Native

Nest

Precious

Pulse

Sense

Splash

Timber

Urban

Wooden

Technical Specifications ▼

Mémorable

Collection



8 mm



GRIFFE BLANC
60x90 Ret. **LT-3430**



GRIFFE TAUPE
60x90 Ret. **LT-3430**



GRIFFE GRIS
60x90 Ret. **LT-3430**



CUBE BLANC
30x60 Ret. Touch **LT-1810**



CUBE TAUPE
30x60 Ret. Touch **LT-1810**



CUBE GRIS
30x60 Ret. Touch **LT-1810**



Mémorable

Collection



8 mm

Coloured Body
PORCELAIN



TACO MÉMORABLE BLANC
10x10 Touch **LP-6010**



TACO MÉMORABLE TAUPE
10x10 Touch **LP-6010**



TACO MÉMORABLE GRIS
10x10 Touch **LP-6010**



MOSAIC MÉMORABLE BLANC
30x30 Touch **LP-6290**



MOSAIC MÉMORABLE TAUPE
30x30 Touch **LP-6290**



MOSAIC MÉMORABLE GRIS
30x30 Touch **LP-6290**



BRICK MÉMORABLE BLANC
25x45 **LP-6340**



BRICK MÉMORABLE TAUPE
25x45 **LP-6340**



BRICK MÉMORABLE GRIS
25x45 **LP-6340**

Index

Colour Map

Collections

Arise

Avenue

Balance

Canyon

Core

Genesis

Gravity

Ground

Light

Marble

Mémorable

Metallic

Native

Nest

Precious

Pulse

Sense

Splash

Timber

Urban

Wooden

Technical Specifications

Mémorable

Collection

UGL PEÇAS ESPECIAIS | SPECIAL PIECES | PIÈCES SPÉCIALES | SPEZIALTEILE | СПЕЦИАЛЬНЫЕ ИЗДЕЛИЯ | PEZZI SPECIALI

Coloured Body
PORCELAIN

OUTDOOR
EXTRA THICK

PEÇAS ESPECIAIS | SPECIAL PIECES | PIÈCES SPÉCIALES | SPEZIALTEILE | СПЕЦИАЛЬНЫЕ ИЗДЕЛИЯ | PEZZI SPECIALI UGL

8 mm

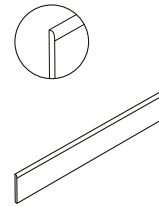

Rodapé Mémorable
Skirting Mémorable
Plinthe Mémorable
Sockel Mémorable
Плинтуса Mémorable
Battiscopa Mémorable

8x90 Ret. **LP-6130**
8x90 Ret. Touch **LP-6130**
8x60 Ret. **LP-6075**
8x60 Ret. Touch **LP-6075**

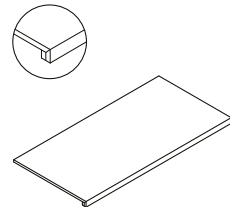

Degrau Espessurado
Step Extra Fluted
Nez De Marche Forte Épaisseur
Massive Stufenplatte
Ступень Утолщенная
Gradino Spessorato

30x90 Ret. **LP-6590**
30x90 Ret. Touch **LP-6590**
30x90 Ret. AS **LP-6590**
30x60 Ret. **LP-6560**
30x60 Ret. Touch **LP-6560**
30x60 Ret. AS **LP-6560**

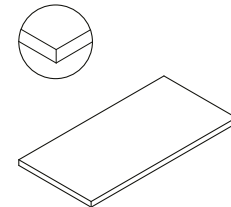

* Degrau Espessurado Canto
Step Extra Thick Corner
Nez De Marche Forte Épaisseur Angle
Ecke massive stufenplatte
Угловая ступень утолщенная
Angolo gradino spessorato

30x90 Ret. **LP-6670**
30x90 Ret. Touch **LP-6670**
30x90 Ret. AS **LP-6670**
30x60 Ret. **LP-6630**
30x60 Ret. Touch **LP-6630**
30x60 Ret. AS **LP-6630**

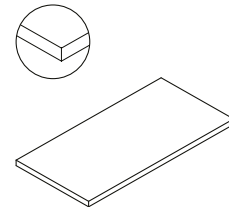

Base
Straight edge
Margelle
Stufenplatte
Ступень базовая
Gradino costa retta

30x60 Ret. 20mm AS **LP-6435**

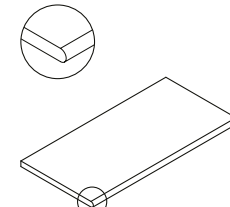

Base boleada
Bullnose
Margelle arrondie
Stufenplatte abgerundet
Ступень с закругленной фаской
Gradino costa toro

30x60 Ret. 20mm AS **LP-6585**

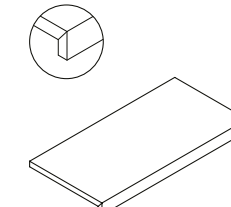

Degrau Espessurado 20mm
Step extra thick 20mm
Nez de marche forte épaisseur 20mm
Massive stufenplatte 20mm
Ступень утолщенная 20mm
Gradino spessorato 20mm

30x60 Ret. 20mm AS **LP-6590**
30x90 Ret. 20mm AS **LP-6630**

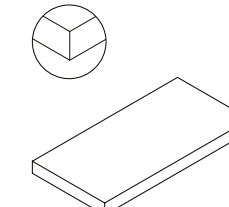

* Degrau Espessurado 20mm Canto
Step extra thick 20mm corner
Nez de marche forte épaisseur 20mm angle
Ecke massive stufenplatte 20mm
Угловая ступень утолщенная 20mm
Angolo gradino spessorato 20mm

30x60 Ret. 20mm AS **LP-6660**
30x90 Ret. 20mm AS **LP-6690**

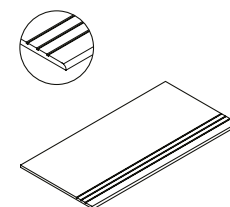

Degrau Sulcado
Step Tread Grooved
Nez De Marche Creusé
Stufenplatte Mit Rillen
Ступень С Насечками
Gradino Con Solchi

30x90 Ret. **LP-6490**
30x90 Ret. Touch **LP-6490**
30x90 Ret. AS **LP-6490**
30x60 Ret. **LP-6350**
30x60 Ret. Touch **LP-6350**
30x60 Ret. AS **LP-6350**

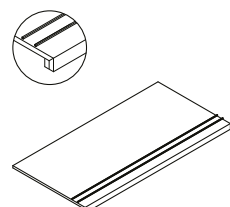

Degrau Espessurado Inox
Step Extra Thick Inox
Nez De Marche Forte Épaisseur Inox
Massive Stufenplatte Inox
Ступень Утолщенная С Металлическими Вставками
Gradino spessorato inox

30x90 Ret. **LP-6620**
30x90 Ret. Touch **LP-6620**
30x60 Ret. **LP-6580**
30x60 Ret. Touch **LP-6580**

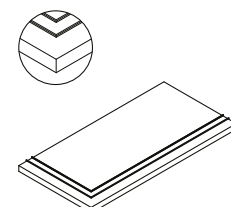

* Degrau Espessurado Canto Inox
Step Extra Thick Corner Inox
Nez De Marche Forte Épaisseur Angle Inox
Ecke massive stufenplatte inox
Угловая ступень утолщенная с металлическими вставками
Angolo gradino spessorato inox

30x90 Ret. **LP-6690**
30x90 Ret. Touch **LP-6690**
30x60 Ret. **LP-6650**
30x60 Ret. Touch **LP-6650**

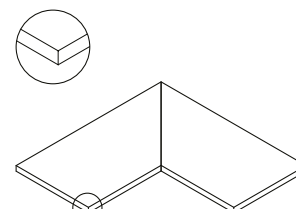

** Canto interior
Straight edge inner corner
Margelle angle bord droit intérieur
Eckstufe
Внутренний угол
Angolo interno

30x60 Ret. 20mm AS **LP-6532**

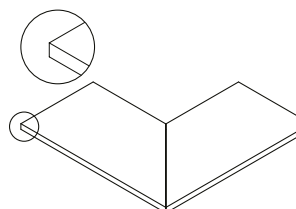

** Canto exterior
Straight edge outer corner
Margelle angle bord droit extérieur
Eckstufe Außenseite
Внешний угол
Angolo esterno

30x60 Ret. 20mm AS **LP-6532**

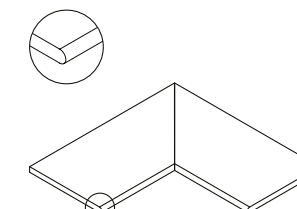

** Canto interior boleado
Bullnose inner corner
Margelle bord intérieur arrondi
Abgerundete Innenecke (Gärung)
Внутренний угол с фаской
Gradino con bordo interno a toro

30x60 Ret. 20mm AS **LP-6720**

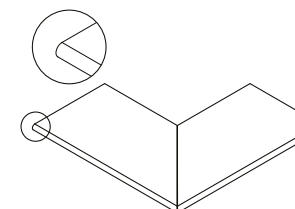

** Canto exterior boleado
Bullnose outer corner
Margelle bord extérieur arrondi
Abgerundete Aussenecke (Gärung)
Внешний угол с фаской
Gradino con bordo esterno a toro

30x60 Ret. 20mm AS **LP-6720**

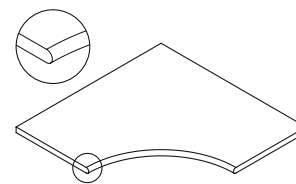

*** Canto interior redondo boleado
Internal corner bullnose
Margelle angle rentrant arrondi
Abgerundete Innenecke
Угол внутренний округлый с фаской
Gradino ad angolo rientrante con toro

60x60 Ret. 20mm AS **LP-6690**

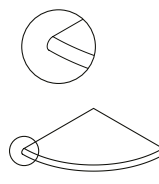

*** Canto exterior redondo boleado
External corner bullnose
Margelle angle sortant arrondi
Abgerundete Aussenecke
Угол внешний округлый с фаской
Gradino ad angolo sporgente con toro

30x30 Ret. 20mm AS **LP-6590**

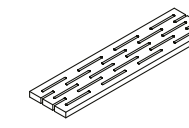

Grelha LT
Overflow grille LT
Grille LT
Überlauf LT
Решетка LT
Griglia LT

15x60 Ret. 20mm AS **LP-6520**

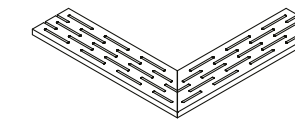

** Canto grelha LT
Overflow corner grille LT
Angle grille LT
Überlauf Ecke LT
Углы решетки LT
Griglia ad angolo LT

15x60 Ret. 20mm AS **LP-6690**

* Disponível no canto direito e esquerdo - Available in right and left corner - Disponible dans les coin droit et gauche
Erhältlich in der rechten Ecke und links - Доступна как правая так и левая угловая ступень - Disponibile nell'angolo destro e sinistro

* Disponível no canto direito e esquerdo - Available in right and left corner - Disponible dans les coin droit et gauche
Erhältlich in der rechten Ecke und links - Доступна как правая так и левая угловая ступень - Disponibile nell'angolo destro e sinistro

** Vendita ao par - Sold per two pieces set - Vendu à la paire
* Paarweise verkauft - Продаётся в комплекте состоящим из двух штук - Venduta a coppie

*** Raio - Radius - Rayon - Radius - Radius - Радиус LT: 30cm



Arise Beige
80 x 80 Ret.

Arise

Collection

DOWNLOAD CATALOGUE  VIEW ONLINE 

Coloured Body
PORCELAIN



UGL

V2



R11
Anti-slip

C
Anti-slip

>36
Anti-slip

80 x 80  9 mm

30 x 60 · 60 x 60  8 mm

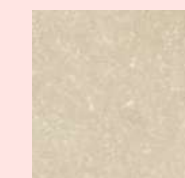

white

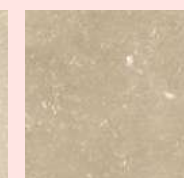

beige



grey



anthracite



pour plus d'informations, consultez
<https://evaluation.cstb.fr>



Index ▾

Colour Map ▾

Collections ▾

Arise

Avenue

Balance

Canyon

Core

Genesis

Gravity

Ground

Light

Marble

Mémorable

Metallic

Native

Nest

Precious

Pulse

Sense

Splash

Timber

Urban

Wooden

Technical Specifications ▾

Arise

Collection



Arise

Collection



Index ▼

Colour Map ▼

Collections ▼

Arise

Avenue

Balance

Canyon

Core

Genesis

Gravity

Ground

Light

Marble

Mémorable

Metallic

Native

Nest

Precious

Pulse

Sense

Splash

Timber

Urban

Wooden

Technical Specifications ▼



Arise Anthracite
30 x 60 Ret.

Mosaic Climb Anthracite
30 x 30

Arise Anthracite
60 x 60 Ret.

Collections ▾

Arise

- Avenue
- Balance
- Canyon
- Core
- Genesis
- Gravity
- Ground
- Light
- Marble
- Mémorable
- Metallic
- Native
- Nest
- Precious
- Pulse
- Sense
- Splash
- Timber
- Urban
- Wooden



Arise

- Avenue
- Balance
- Canyon
- Core
- Genesis
- Gravity
- Ground
- Light
- Marble
- Mémorable
- Metallic
- Native
- Nest
- Precious
- Pulse
- Sense
- Splash
- Timber
- Urban
- Wooden

Arise
Collection

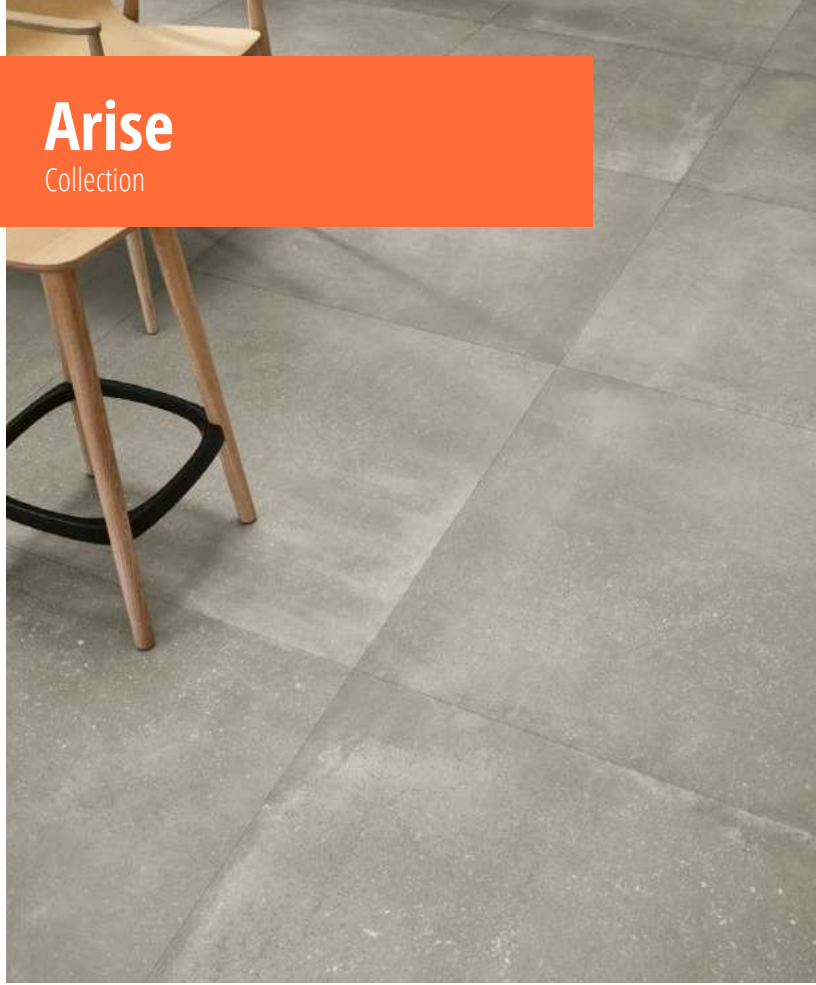

Arise
Collection

[Index](#) ▼

[Colour Map](#) ▼

Collections ▼

Arise

[Avenue](#)

[Balance](#)

[Canyon](#)

[Core](#)

[Genesis](#)

[Gravity](#)

[Ground](#)

[Light](#)

[Marble](#)

[Mémorable](#)

[Metallic](#)

[Native](#)

[Nest](#)

[Precious](#)

[Pulse](#)

[Sense](#)

[Splash](#)

[Timber](#)

[Urban](#)

[Wooden](#)



80x80 > 9 mm | 61x61 - 60x60 - 30x60 > 8 mm



ARISE WHITE
80x80 Ret. **LT-2870**
80x80 Ret. AS **LT-2900**



ARISE WHITE
61x61 **LT-2170**
61x61 AS **LT-2215**
60x60 Ret. **LT-2450**

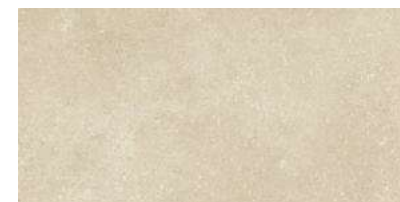

ARISE WHITE
30x60 Ret. **LT-1840**

Coloured Body
PORCELAIN



ARISE GREY
30x60 Ret. **LT-1840**



ARISE GREY
61x61 **LT-2170**
61x61 AS **LT-2215**
60x60 Ret. **LT-2450**



80x80 > 9 mm | 61x61 - 60x60 - 30x60 > 8 mm



ARISE GREY
80x80 Ret. **LT-2870**
80x80 Ret. AS **LT-2900**



ARISE BEIGE
61x61 **LT-2170**
61x61 AS **LT-2215**
60x60 Ret. **LT-2450**



ARISE BEIGE
30x60 Ret. **LT-1840**



ARISE ANTHRACITE
30x60 Ret. **LT-1840**



ARISE ANTHRACITE
61x61 **LT-2170**
61x61 AS **LT-2215**
60x60 Ret. **LT-2450**



ARISE ANTHRACITE
80x80 Ret. **LT-2870**
80x80 Ret. AS **LT-2900**



8 mm



MOSAIC CLIMB WHITE
30x30 **LP-6290**



MOSAIC CLIMB BEIGE
30x30 **LP-6290**



MOSAIC CLIMB GREY
30x30 **LP-6290**



MOSAIC CLIMB ANTHRACITE
30x30 **LP-6290**



MOSAIC ARISE WHITE
30x30 **LP-6290**



MOSAIC ARISE BEIGE
30x30 **LP-6290**



MOSAIC ARISE GREY
30x30 **LP-6290**



MOSAIC ARISE ANTHRACITE
30x30 **LP-6290**



MURETO UPLIFT WHITE
30x40 **STOCK OFF** **LP-6310**



MURETO UPLIFT BEIGE
30x40 **STOCK OFF** **LP-6310**



MURETO UPLIFT GREY
30x40 **STOCK OFF** **LP-6310**



MURETO UPLIFT ANTHRACITE
30x40 **STOCK OFF** **LP-6310**

Coloured Body
PORCELAIN

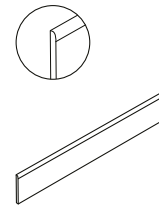

Rodapé Arise
Skirting Arise
Plinthe Arise
Sockel Arise
Плинтуса Arise
Battiscopa Arise

8x80 Ret. **LP-6130**
8x61 **LP-6075**
8x60 Ret. **LP-6075**

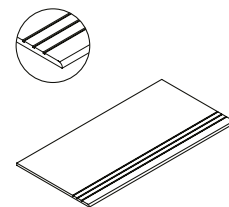

Degrau Sulcado
Step Tread Grooved
Nez De Marche Creusé
Stufenplatte Mit Rillen
Ступень С Насечками
Gradino Con Solchi

30x80 Ret. **LP-6490**
30x80 Ret. AS **LP-6490**
30x61 **LP-6350**
30x61 AS **LP-6350**
30x60 Ret. **LP-6350**

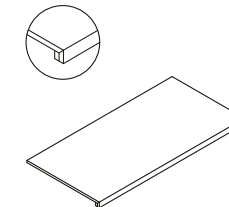

Degrau Espessurado
Step Extra Fluted
Nez De Marche Forte Épaisseur
Massive Stufenplatte
Ступень Утолщенная
Gradino Spessorato

30x80 Ret. **LP-6590**
30x80 Ret. AS **LP-6590**
30x60 Ret. **LP-6560**

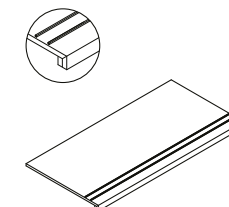

Degrau Espessurado Inox
Step Extra Thick Inox
Nez De Marche Forte Épaisseur Inox
Massive Stufenplatte Inox
Ступень Утолщенная С Металлическими Вставками
Gradino Spessorato Inox

30x80 Ret. **LP-6620**
30x60 Ret. **LP-6580**



30x80 · 8x80 · 9 mm | 30x61 · 30x60 · 8x61 · 8x60 · 8 mm

PEÇAS ESPECIAIS | SPECIAL PIECES | PIÈCES SPÉCIALES | SPEZIALTEILE | СПЕЦИАЛЬНЫЕ ИЗДЕЛИЯ | PEZZI SPECIALI

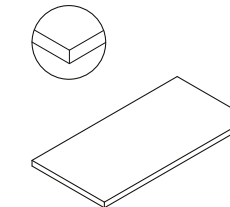

* Degrau Espessurado Canto
Step Extra Thick Corner
Nez De Marche Forte Épaisseur Angle
Ecke massive stufenplatte
Угловая ступень утолщенная
Angolo gradino spessorato

30x80 Ret. **LP-6670**
30x80 Ret. AS **LP-6670**
30x60 Ret. **LP-6630**

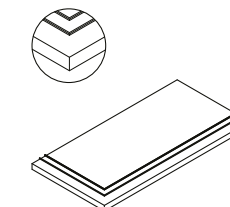

* Degrau Espessurado Canto Inox
Step Extra Thick Corner Inox
Nez De Marche Forte Épaisseur Angle Inox
Ecke massive stufenplatte inox
Угловая ступень утолщенная с металлическими вставками
Angolo gradino spessorato inox

30x80 Ret. **LP-6690**
30x60 Ret. **LP-6650**

*Disponível no canto direito e esquerdo · Available in right and left corner · Disponible dans les coin droit et gauche
Erhältlich in der rechten Ecke und links · Доступна как правая так и левая угловая ступень · Disponibile nell'angolo destro e sinistro

**A dimensão varia consoante a espessura do material cerâmico · Dimension will vary depending on the base tile thickness · La dimension varie selon l'épaisseur du carreau
Das Maß variiert je nach Dicke der Fliese · Размер варьируется в зависимости от толщины керамического материала · La dimensione varia a seconda dello spessore della piastrella di base

Arise

Avenue

Balance

Canyon

Core

Genesis

Gravity

Ground

Light

Marble

Mémorable

Metallic

Native

Nest

Precious

Pulse

Sense

Splash

Timber

Urban

Wooden



Balance Beige
80 x 80 Ret.

Balance

Collection

VIEW VIDEO

DOWNLOAD CATALOGUE

VIEW ONLINE

Coloured Body
PORCELAIN

80 x 80 9 mm
30 x 60 · 60 x 60 8 mm



pour plus d'informations, consultez
<https://evaluation.cstb.fr>



Index ▾

Colour Map ▾

Collections ▾

- Arise
- Avenue
- Balance**
- Canyon
- Core
- Genesis
- Gravity
- Ground
- Light
- Marble
- Mémorable
- Metallic
- Native
- Nest
- Precious
- Pulse
- Sense
- Splash
- Timber
- Urban
- Wooden

Technical Specifications ▾

Balance

Collection



Balance

Collection



Index ▼

Colour Map ▼

Collections ▼

Arise

Avenue

Balance

Canyon

Core

Genesis

Gravity

Ground

Light

Marble

Mémorable

Metallic

Native

Nest

Precious

Pulse

Sense

Splash

Timber

Urban

Wooden

Technical Specifications ▼

Balance

Collection



Balance White
80 x 80 Ret.



Balance

Collection

Balance Beige
80 x 80 Ret. AS

Index ▼

Colour Map ▼

Collections ▼

- Arise
- Avenue
- Balance**
- Canyon
- Core
- Genesis
- Gravity
- Ground
- Light
- Marble
- Mémorable
- Metallic
- Native
- Nest
- Precious
- Pulse
- Sense
- Splash
- Timber
- Urban
- Wooden

Technical Specifications ▼

Balance

Collection



Balance Light Grey
60 x 60 Ret.

Balance

Collection



Balance Grey
30 x 60 Ret. Touch

Mosaic Balance Grey
30 x 30 Touch

Balance Grey
60 x 60 Ret. Touch

Index ▼

Colour Map ▼

Collections ▼

- Arise
- Avenue
- Balance**
- Canyon
- Core
- Genesis
- Gravity
- Ground
- Light
- Marble
- Mémorable
- Metallic
- Native
- Nest
- Precious
- Pulse
- Sense
- Splash
- Timber
- Urban
- Wooden

Technical Specifications ▼



8 mm

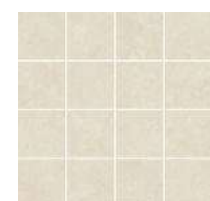

MOSAIC BALANCE WHITE
30x30 Touch **LP-6290**



MOSAIC BALANCE BEIGE
30x30 Touch **LP-6290**



MOSAIC BALANCE LIGHT GREY
30x30 Touch **LP-6290**



MOSAIC BALANCE GREY
30x30 Touch **LP-6290**



MURETO BALANCE WHITE
29x30 Touch **LP-6310**



MURETO BALANCE BEIGE
29x30 Touch **LP-6310**



MURETO BALANCE LIGHT GREY
29x30 Touch **LP-6310**



MURETO BALANCE GREY
29x30 Touch **LP-6310**

Coloured Body
PORCELAIN

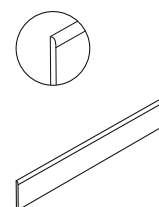

Rodapé Balance
Skirting Balance
Plinthe Balance
Sockel Balance
Плинтуса Balance
Battiscopa Balance

8x80 Ret. **LP-6130**
8x80 Ret. Touch **LP-6130**
8x61 **LP-6075**
8x60 Ret. **LP-6075**
8x60 Ret. Touch **LP-6075**

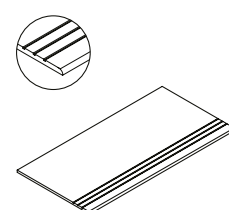

Degrau Sulcado
Step Tread Grooved
Nez De Marche Creusé
Stufenplatte Mit Rillen
Ступень С Насечками
Gradino Con Solchi

30x80 Ret. **LP-6490**
30x80 Ret. Touch **LP-6490**
30x80 Ret. AS **LP-6490**
31x61 **LP-6350**
30x61 **LP-6350**
30x61 AS **LP-6350**
30x60 Ret. **LP-6350**
30x60 Ret. Touch **LP-6350**

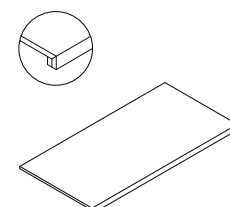

Degrau Espessurado
Step Extra Fluted
Nez De Marche Forte Épaisseur
Massive Stufenplatte
Ступень Утолщенная
Gradino Spessorato

30x80 Ret. **LP-6590**
30x80 Ret. Touch **LP-6590**
30x80 Ret. AS **LP-6590**
30x60 Ret. **LP-6560**
30x60 Ret. Touch **LP-6560**

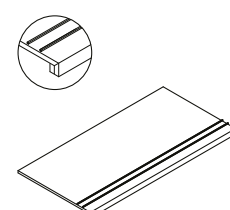

Degrau Espessurado Inox
Step Extra Thick Inox
Nez De Marche Forte Épaisseur Inox
Massive Stufenplatte Inox
Ступень Утолщенная С Металлическими Вставками
Gradino Spessorato Inox

30x80 Ret. **LP-6620**
30x80 Ret. Touch **LP-6620**
30x60 Ret. **LP-6580**
30x60 Ret. Touch **LP-6580**



30x80 - 8x80 - 9 mm | 31x61 - 30x61 - 30x60 - 8x61 - 8x60 - 8 mm

PEÇAS ESPECIAIS | SPECIAL PIECES | PIÈCES SPÉCIALES | SPEZIALTEILE | СПЕЦИАЛЬНЫЕ ИЗДЕЛИЯ | PEZZI SPECIALI

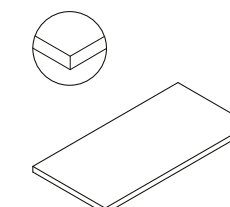

* Degrau Espessurado Canto
Step Extra Thick Corner
Nez De Marche Forte Épaisseur Angle
Ecke massive stufenplatte
Угловая ступень утолщенная
Angolo gradino spessorato

30x80 Ret. **LP-6670**
30x80 Ret. Touch **LP-6670**
30x80 Ret. AS **LP-6670**
30x60 Ret. **LP-6630**
30x60 Ret. Touch **LP-6630**

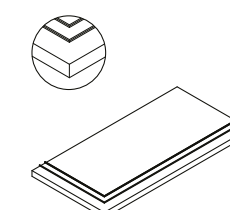

* Degrau Espessurado Canto Inox
Step Extra Thick Corner Inox
Nez De Marche Forte Épaisseur Angle Inox
Ecke massive stufenplatte inox
Угловая ступень утолщенная с металлическими вставками
Angolo gradino spessorato inox

30x80 Ret. **LP-6690**
30x80 Ret. Touch **LP-6690**
30x60 Ret. **LP-6650**
30x60 Ret. Touch **LP-6650**



Chevron Ginger
20 x 80

322

Native

Collection

VIEW VIDEO DOWNLOAD CATALOGUE VIEW ONLINE

40 x 120 20 mm
20 x 100 8 mm



PROTECT **UPEC-F+**
Antibacterial for Life.
pour plus d'informations, consultez <https://evaluation.cstb.fr>

LOVE
CERAMIC TILES

Index ▼

Colour Map ▼

Collections ▼

- Arise
- Avenue
- Balance
- Canyon
- Core
- Genesis
- Gravity
- Ground
- Light
- Marble
- Mémorable
- Metallic
- Native**
- Nest
- Precious
- Pulse
- Sense
- Splash
- Timber
- Urban
- Wooden

Technical Specifications ▼

Native

Collection



Precious Calacatta
45 x 119 Ret.

Native Tortora
20 x 100

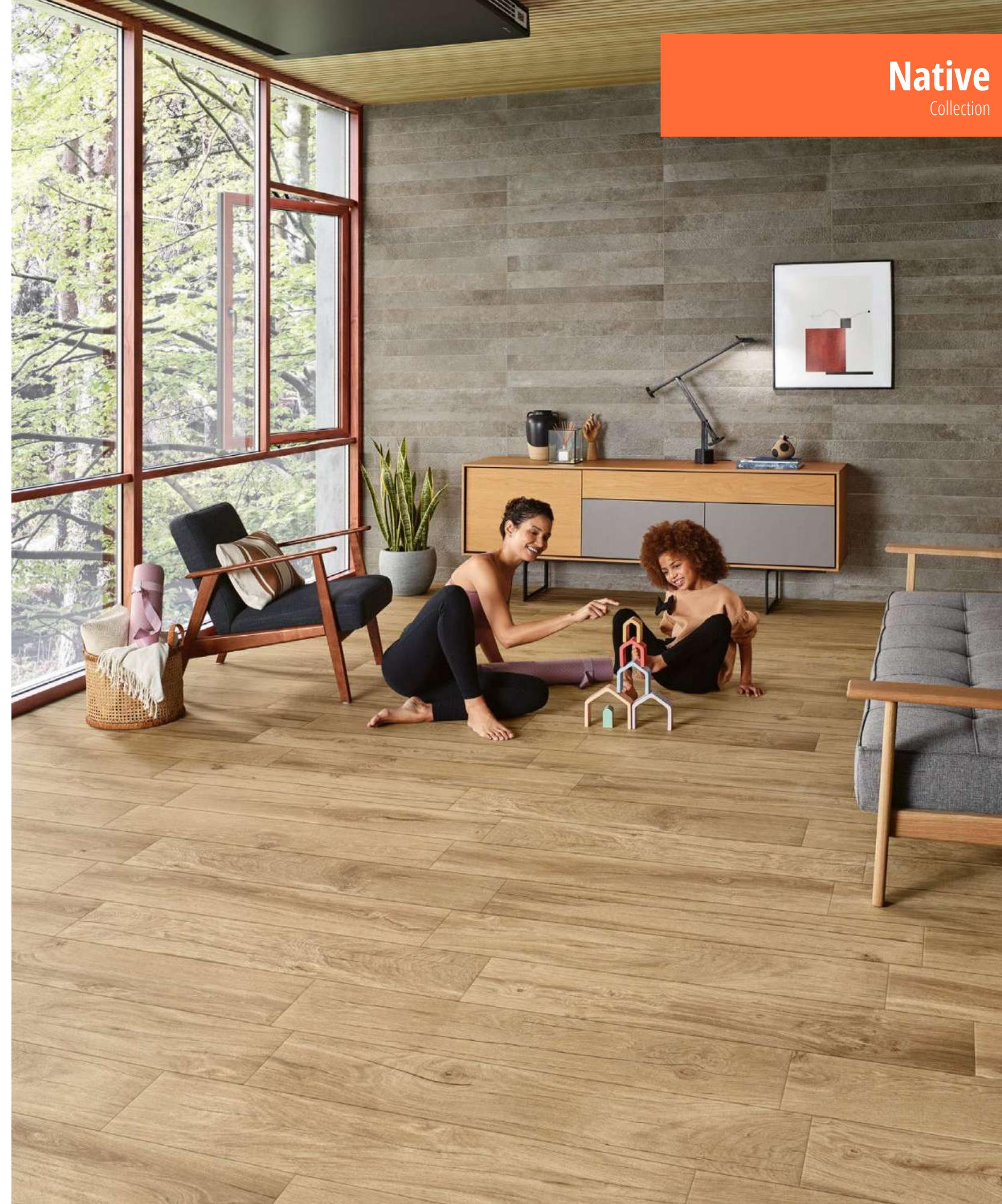

Native

Collection

Mémorable Griffe Gris
60 x 90 Ret.

Native Dark Beige
20 x 100

Index ▼

Colour Map ▼

Collections ▼

- Arise
- Avenue
- Balance
- Canyon
- Core
- Genesis
- Gravity
- Ground
- Light
- Marble
- Mémorable
- Metallic
- Native**
- Nest
- Precious
- Pulse
- Sense
- Splash
- Timber
- Urban
- Wooden

Technical Specifications ▼

Native

Collection



Native White
20 x 100

Native

Collection



Native Grey
20 x 100 AS

Index ▼

Colour Map ▼

Collections ▼

- Arise
- Avenue
- Balance
- Canyon
- Core
- Genesis
- Gravity
- Ground
- Light
- Marble
- Mémorable
- Metallic
- Native**
- Nest
- Precious
- Pulse
- Sense
- Splash
- Timber
- Urban
- Wooden

Technical Specifications ▼

Native

Collection



Native

Collection

Native Light Beige
20 x 100

Index ▾

Colour Map ▾

Collections ▾

- Arise
- Avenue
- Balance
- Canyon
- Core
- Genesis
- Gravity
- Ground
- Light
- Marble
- Mémorable
- Metallic
- Native**
- Nest
- Precious
- Pulse
- Sense
- Splash
- Timber
- Urban
- Wooden

Technical Specifications ▾

Native

Collection

Native

Collection



Index ▼

Colour Map ▼

Collections ▼

- Arise
- Avenue
- Balance
- Canyon
- Core
- Genesis
- Gravity
- Ground
- Light
- Marble
- Mémorable
- Metallic
- Native**
- Nest
- Precious
- Pulse
- Sense
- Splash
- Timber
- Urban
- Wooden

Technical Specifications ▼

LOVE
CERAMIC TILES

Native 20mm Dark Beige
40 x 120 Ret. AS



8 mm



NATIVE GINGER
20x100 LT-1270



NATIVE DARK BEIGE
20x100 LT-1270
20x100 AS LT-1300



NATIVE LIGHT BEIGE
20x100 LT-1270
20x100 AS LT-1300



NATIVE WHITE
20x100 LT-1270



NATIVE TORTORA
20x100 LT-1270



NATIVE GREY
20x100 LT-1270
20x100 AS LT-1300

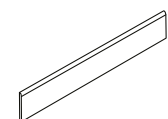

RODAPÉ NATIVE
8x100 LP-6090



8 mm



CHEVRON GINGER
20x80 LT-5435



CHEVRON DARK BEIGE
20x80 LT-5435



CHEVRON LIGHT BEIGE
20x80 LT-5435



CHEVRON WHITE
20x80 LT-5435



CHEVRON TORTORA
20x80 LT-5435



CHEVRON GREY
20x80 LT-5435

Acabamento retificado nas arestas menores e não retificado nas arestas maiores.
Rectified finishing in lower edges and non-rectified finishing in higher edges.
Finition rectifiée sur les petites arêtes et finition non rectifiée sur les grandes arêtes.
Retifiziert oberfläche an den Nebenkante und Presskante oberfläche an den größeren Kante.
Изделие ректифицированное с двух меньших сторон и неректифицированное с двух больших сторон.
Finitura rettificata sui bordi più piccoli e finitura non rettificata sui bordi più grandi.

- Arise
- Avenue
- Balance
- Canyon
- Core
- Genesis
- Gravity
- Ground
- Light
- Marble
- Mémorable
- Metallic
- Native**
- Nest
- Precious
- Pulse
- Sense
- Splash
- Timber
- Urban
- Wooden

Native

Collection



20 mm



NATIVE 20MM DARK BEIGE
40x120 Ret. AS LT-4000



NATIVE 20MM GREY
40x120 Ret. AS LT-4000



pour plus d'informations, consultez
<https://evaluation.cstb.fr>

Native

Collection

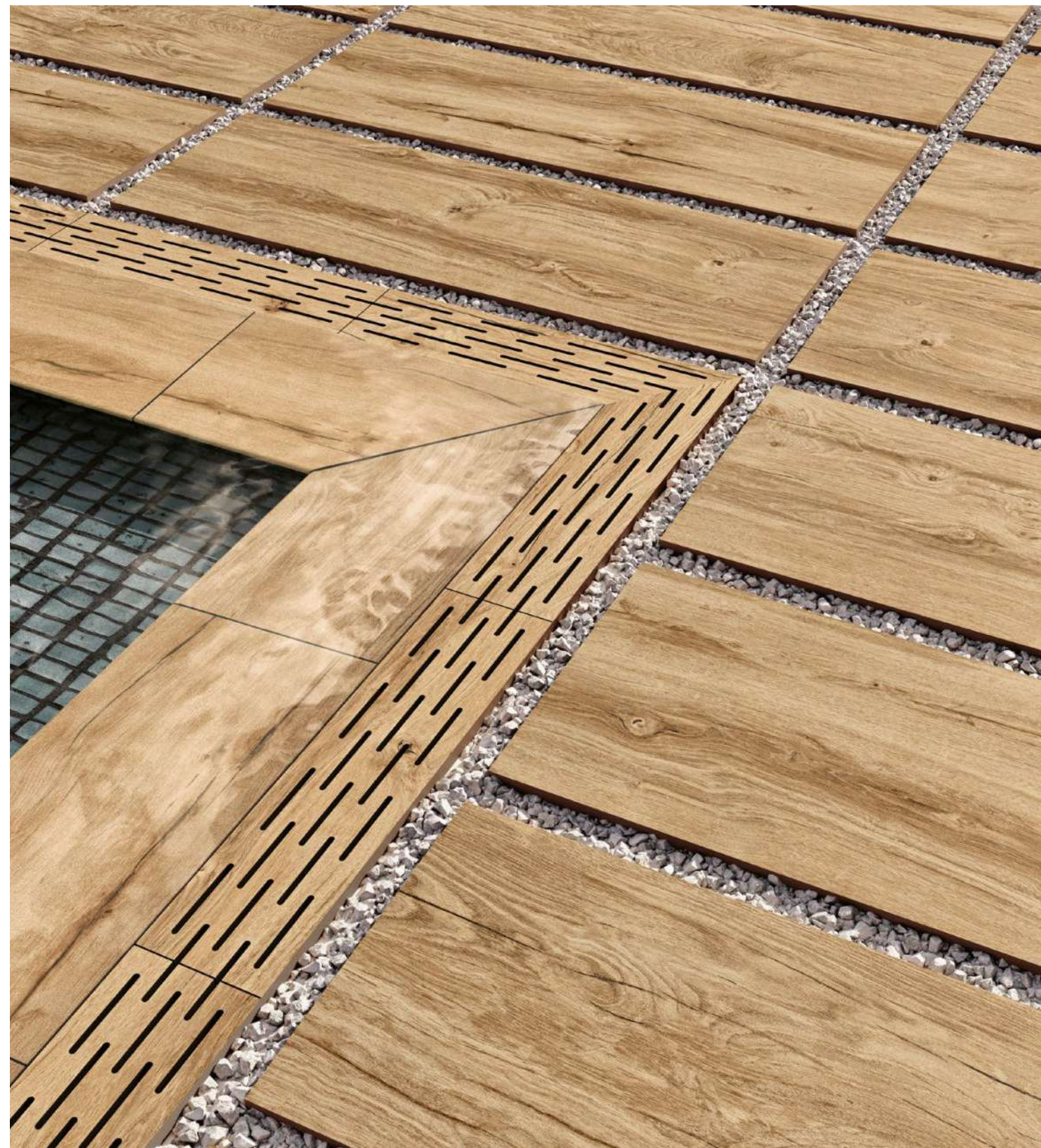

Native 20mm Dark Beige
40 x 120 Ret. AS

Index ▾

Colour Map ▾

Collections ▾

- Arise
- Avenue
- Balance
- Canyon
- Core
- Genesis
- Gravity
- Ground
- Light
- Marble
- Mémorable
- Metallic
- Native**
- Nest
- Precious
- Pulse
- Sense
- Splash
- Timber
- Urban
- Wooden

Technical Specifications ▾

OUTDOOR EXTRA THICK

PEÇAS ESPECIAIS | SPECIAL PIECES | PIÈCES SPÉCIALES | SPEZIALTEILE | СПЕЦИАЛЬНЫЕ ИЗДЕЛИЯ | PEZZI SPECIALI



20 mm

SUGESTÕES DE APLICAÇÃO | LAYING SUGGESTIONS | SUGGESTIONS DE POSE | ANWENDUNGSVORSCHLÄGE | СОВЕТЫ ПО УКЛАДКЕ | SUGGERIMENTI DI POSA

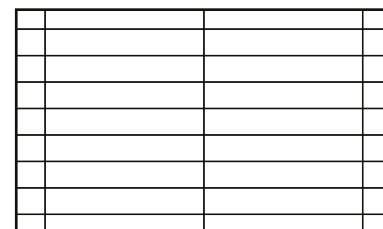

Pág 324

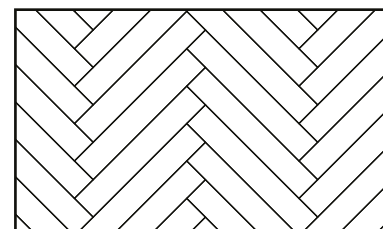

Pág 325

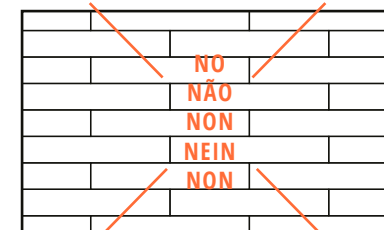
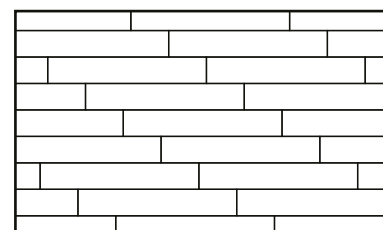
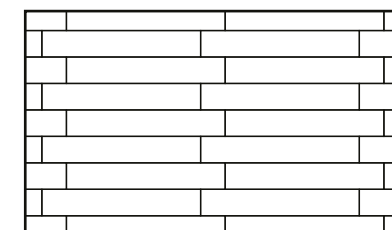
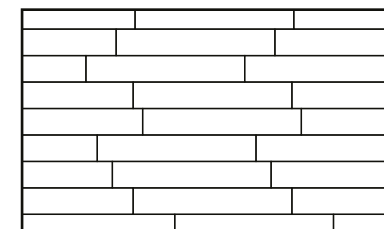

CHEVRON:
SUGESTÕES DE APLICAÇÃO | LAYING SUGGESTIONS | SUGGESTIONS DE POSE | ANWENDUNGSVORSCHLÄGE | СОВЕТЫ ПО УКЛАДКЕ | SUGGERIMENTI DI POSA

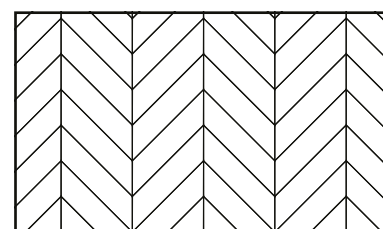

Pág 322

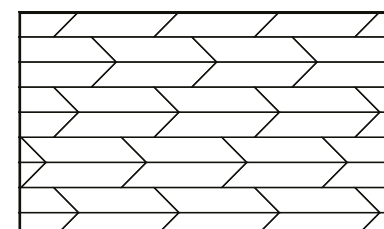
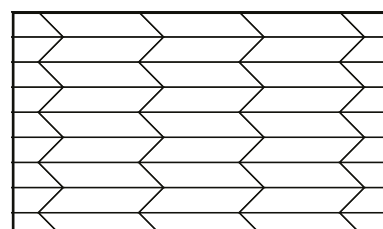

PROTECT

Antibacterial for Life.

Uma linha exclusiva de pavimentos e revestimentos antimicrobianos de altíssima performance, projetada para ambientes saudáveis, seguros e protegidos. Por favor consulte a página 374.
An exclusive line of extremely high performance antimicrobial floor and wall tiles, designed for healthy, safe and protected living spaces. Please see page 374.
Une ligne exclusive de sols et revêtements antibactériens aux performances très élevées, pour un habitat sain, sûr et protégé. Veuillez-vous consulter la page 374.
Eine exklusive Linie an hochwertigen Fußböden und antibakteriellen Wandverkleidungen, für ein gesundes, sicheres und geschütztes Leben. Bitte beachten Sie Seite 374.
Эксклюзивная линия высокоэффективных противомикробных покрытий, предназначенных для здоровой, безопасной и защищенной окружающей среды. Пожалуйста, посмотрите информацию на странице 374.
Una linea esclusiva di pavimenti e rivestimenti antimicrobici ad altissime prestazioni, ideata per ambienti abitativi sani, sicuri e protetti. Si prega di fare riferimento alla pagina 374.

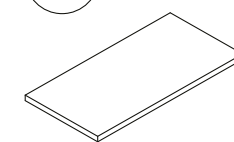

Base
Straight edge
Margelle
Stufenplatte
Ступень базовая
Gradino costa retta

30x60 Ret. 20mm AS LP-6435

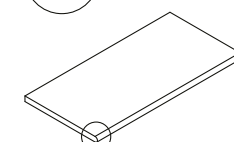

Base boleada
Bullnose
Margelle arredie
Stufenplatte abgerundet
Ступень с закругленной фаской
Gradino costa toro

30x60 Ret. 20mm AS LP-6585

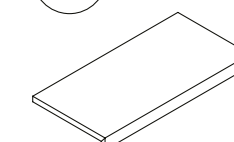

Degrau Espessurado 20mm
Step extra thick 20mm
Nez de marche forte épaisseur 20mm
Massive stufenplatte 20mm
Ступень утолщенная 20mm
Gradino spessorato 20mm

30x60 Ret. 20mm AS LP-6590
30x120 Ret. 20mm AS LP-6690

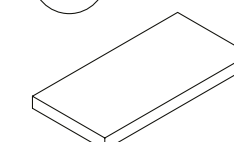

* Degrau Espessurado 20mm Canto
Step extra thick 20mm corner
Nez de marche forte épaisseur 20mm angle
Ecke massive stufenplatte 20mm
Угловая ступень утолщенная 20mm
Angolo gradino spessorato 20mm

30x60 Ret. 20mm AS LP-6660
30x120 Ret. 20mm AS LP-6740

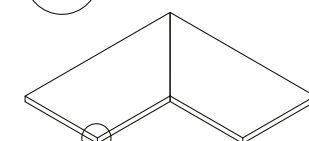

** Canto interior
Straight edge inner corner
Margelle angle bord droit intérieur
Eckstufe
Внутренний угол
Angolo interno

30x60 Ret. 20mm AS LP-6532

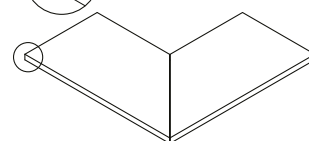

** Canto exterior
Straight edge outer corner
Margelle angle bord droit extérieur
Eckstufe Außenseite
Внешний угол
Angolo esterno

30x60 Ret. 20mm AS LP-6532

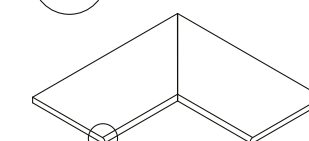

** Canto interior boleado
Bullnose inner corner
Margelle bord intérieur arrondi
Abgerundete Innenecke (Gärung)
Внутренний угол с фаской
Gradino con bordo interno a toro

30x60 Ret. 20mm AS LP-6720

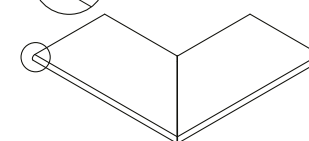

** Canto exterior boleado
Bullnose outer corner
Margelle bord extérieur arrondi
Abgerundete Aussenecke (Gärung)
Внешний угол с фаской
Gradino con bordo esterno a toro

30x60 Ret. 20mm AS LP-6720

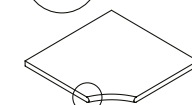

*** Canto interior redondo boleado
Internal corner bullnose
Margelle angle rentrant arrondi
Abgerundete Innenecke
Угол внутренний округлый с фаской
Gradino ad angolo rientrante con toro

40x40 Ret. 20mm AS LP-6690



**** Canto exterior redondo boleado
External corner bullnose
Margelle angle sortant arrondi
Abgerundete Aussenecke
Угол внешний округлый с фаской
Gradino ad angolo sporgente con toro

30x30 Ret. 20mm AS LP-6590

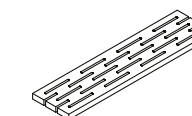

Grelha LT
Overflow grille LT
Grille LT
Überlauf LT
Решетка LT
Griglia LT

15x60 Ret. 20mm AS LP-6520

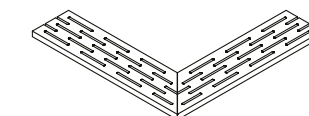

** Canto grelha LT
Overflow corner grille LT
Angle grille LT
Überlauf Ecke LT
Углы решетки LT
Griglia ad angolo LT

15x60 Ret. 20mm AS LP-6690

* Disponível no canto direito e esquerdo - Available in right and left corner - Disponible dans les coin droit et gauche
Erhältlich in der rechten Ecke und links - Доступна как правая так и левая угловая ступень - Disponibile nell'angolo destro e sinistro

** Vendida ao par - Sold per two pieces set - Vendu à la paire
* Paarweise verkauft - Продается в комплекте состоящим из двух штук - Venduta a coppie

*** Raio - Radius - Rayon - Radius - РадиусLT - Raggio: 10cm
**** Raio - Radius - Rayon - Radius - РадиусLT - Raggio: 30cm





Wooden

Collection

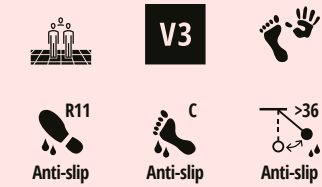
DOWNLOAD CATALOGUE  VIEW ONLINE 



40 x 120  20 mm
 20 x 100  8 mm



light beige beige dark beige



tortora brown

 **UPEC-F+**
 pour plus d'informations, consultez
<https://evaluation.cstb.fr>

LOVE
 CERAMIC TILES

Index ▼

Colour Map ▼

Collections ▼

- Arise
- Avenue
- Balance
- Canyon
- Core
- Genesis
- Gravity
- Ground
- Light
- Marble
- Mémorable
- Metallic
- Native
- Nest
- Precious
- Pulse
- Sense
- Splash
- Timber
- Urban

Wooden

Technical Specifications ▼

Wooden

Collection



Wooden

Collection

Index ▼

Colour Map ▼

Collections ▼

- Arise
- Avenue
- Balance
- Canyon
- Core
- Genesis
- Gravity
- Ground
- Light
- Marble
- Mémorable
- Metallic
- Native
- Nest
- Precious
- Pulse
- Sense
- Splash
- Timber
- Urban

Wooden

Technical Specifications ▼

Wooden

Collection



Wooden Brown
20 x 100

Wooden

Collection



Wooden Tortora
20 x 100 AS

Index ▼

Colour Map ▼

Collections ▼

- Arise
- Avenue
- Balance
- Canyon
- Core
- Genesis
- Gravity
- Ground
- Light
- Marble
- Mémorable
- Metallic
- Native
- Nest
- Precious
- Pulse
- Sense
- Splash
- Timber
- Urban

Wooden

Technical Specifications ▼

Wooden

Collection

Wooden

Collection



Index ▼

Colour Map ▼

Collections ▼

- Arise
- Avenue
- Balance
- Canyon
- Core
- Genesis
- Gravity
- Ground
- Light
- Marble
- Mémorable
- Metallic
- Native
- Nest
- Precious
- Pulse
- Sense
- Splash
- Timber
- Urban

Wooden

Technical Specifications ▼

Wooden

Collection

Wooden

Collection



Index ▼

Colour Map ▼

Collections ▼

- Arise
- Avenue
- Balance
- Canyon
- Core
- Genesis
- Gravity
- Ground
- Light
- Marble
- Mémorable
- Metallic
- Native
- Nest
- Precious
- Pulse
- Sense
- Splash
- Timber
- Urban

Wooden

Technical Specifications ▼



8 mm



WOODEN LIGHT BEIGE

20x100 LT-1270
20x100 AS LT-1300



WOODEN BEIGE

20x100 LT-1270
20x100 AS LT-1300



WOODEN DARK BEIGE

20x100 LT-1270
20x100 AS LT-1300



WOODEN TORTORA

20x100 LT-1270
20x100 AS LT-1300



WOODEN BROWN

20x100 LT-1270
20x100 AS LT-1300

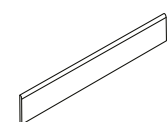

RODAPÉ WOODEN
8x100 LP-6090



8 mm



CHEVRON LIGHT BEIGE

20x80 LT-5435



CHEVRON BEIGE

20x80 LT-5435



CHEVRON DARK BEIGE

20x80 LT-5435



CHEVRON TORTORA

20x80 LT-5435



CHEVRON BROWN

20x80 LT-5435

Acabamento retificado nas arestas menores e não retificado nas arestas maiores.
Rectified finishing in lower edges and non-rectified finishing in higher edges.
Finition rectifiée sur les petites arêtes et finition non rectifiée sur les grandes arêtes.
Retifiziert oberfläche an den Nebenkante und Presskante oberfläche an den größeren Kante.
Изделие ректифицированное с двух меньших сторон и неректифицированное с двух больших сторон.
Finitura rettificata sui bordi più piccoli e finitura non rettificata sui bordi più grandi.

Collections ▾

- Arise
- Avenue
- Balance
- Canyon
- Core
- Genesis
- Gravity
- Ground
- Light
- Marble
- Mémorable
- Metallic
- Native
- Nest
- Precious
- Pulse
- Sense
- Splash
- Timber
- Urban

Wooden



8 mm



MOSAIC WOODEN LIGHT BEIGE
29,5x39,5 LP-6170



MOSAIC WOODEN BEIGE
29,5x39,5 LP-6170



MOSAIC WOODEN DARK BEIGE
29,5x39,5 LP-6170



MOSAIC WOODEN TORTORA
29,5x39,5 LP-6170



MOSAIC WOODEN BROWN
29,5x39,5 LP-6170

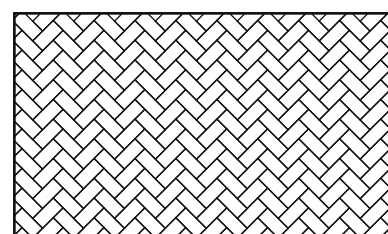

MOSAIC WOODEN RAW LIGHT BEIGE AS
20x49,5 LP-6280



MOSAIC WOODEN RAW BEIGE AS
20x49,5 LP-6280



MOSAIC WOODEN RAW DARK BEIGE AS
20x49,5 LP-6280

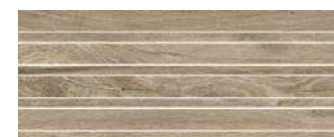

MOSAIC WOODEN RAW TORTORA AS
20x49,5 LP-6280



MOSAIC WOODEN RAW BROWN AS
20x49,5 LP-6280

SUGESTÕES DE APLICAÇÃO | LAYING SUGGESTIONS | SUGGESTIONS DE POSE | ANWENDUNGSVORSCHLÄGE | СОВЕТЫ ПО УКЛАДКЕ | SUGGERIMENTI DI POSA

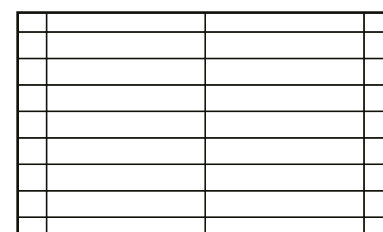

Pág 342

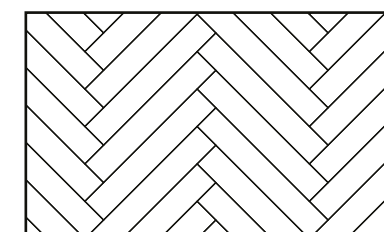

Pág 340 - 341

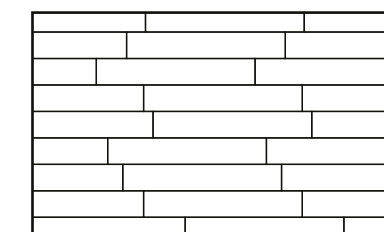

Pág 338 - 339



CHEVRON:
SUGESTÕES DE APLICAÇÃO | LAYING SUGGESTIONS | SUGGESTIONS DE POSE | ANWENDUNGSVORSCHLÄGE | СОВЕТЫ ПО УКЛАДКЕ | SUGGERIMENTI DI POSA

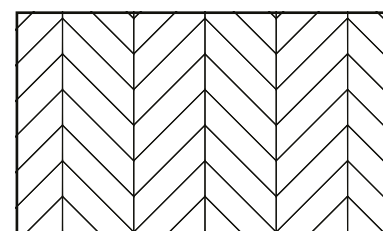

Pág 344 - 345

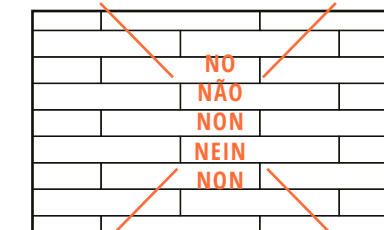
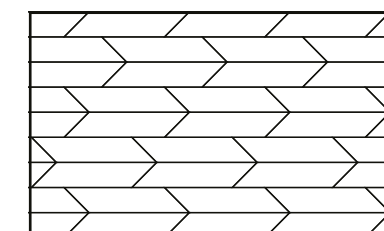
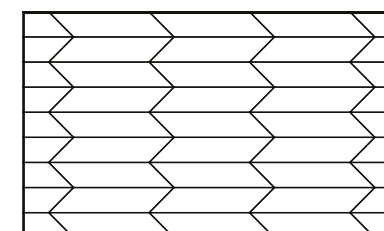

- Arise
- Avenue
- Balance
- Canyon
- Core
- Genesis
- Gravity
- Ground
- Light
- Marble
- Mémorable
- Metallic
- Native
- Nest
- Precious
- Pulse
- Sense
- Splash
- Timber
- Urban



20 mm



WOODEN 20MM DARK BEIGE
40x120 Ret. AS **LT-4000**



WOODEN 20MM TORTORA
40x120 Ret. AS **LT-4000**

OUTDOOR
EXTRA THICK

PEÇAS ESPECIAIS | SPECIAL PIECES | PIÈCES SPÉCIALES | SPEZIALTEILE | СПЕЦИАЛЬНЫЕ ИЗДЕЛИЯ | PEZZI SPECIALI



20 mm

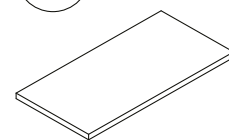

Base
Straight edge
Margelle
Stufenplatte
Ступень базовая
Gradino costa retta

30x60 Ret. 20mm AS **LP-6435**

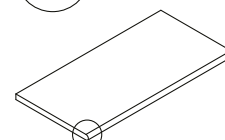

Base boleada
Bullnose
Margelle arrondie
Stufenplatte abgerundet
Ступень с закругленной фаской
Gradino costa toro

30x60 Ret. 20mm AS **LP-6585**

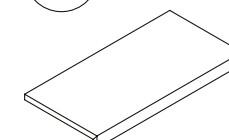

Degrau Espessurado 20mm
Step extra thick 20mm
Nez de marche forte épaisseur 20mm
Massive stufenplatte 20mm
Ступень утолщенная 20mm
Gradino spessorato 20mm

30x60 Ret. 20mm AS **LP-6590**
30x120 Ret. 20mm AS **LP-6690**

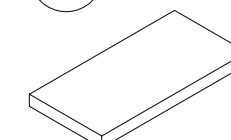

* Degrau Espessurado 20mm Canto
Step extra thick 20mm corner
Nez de marche forte épaisseur 20mm angle
Ecke massive stufenplatte 20mm
Угловая ступень утолщенная 20mm
Angolo gradino spessorato 20mm

30x60 Ret. 20mm AS **LP-6660**
30x120 Ret. 20mm AS **LP-6740**

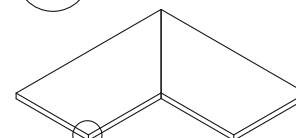

** Canto interior
Straight edge inner corner
Margelle angle bord droit intérieur
Eckstufe
Внутренний угол
Angolo interno

30x60 Ret. 20mm AS **LP-6532**

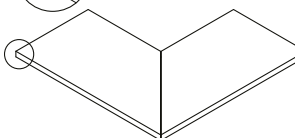

** Canto exterior
Straight edge outer corner
Margelle angle bord droit extérieur
Eckstufe Außenseite
Внешний угол
Angolo esterno

30x60 Ret. 20mm AS **LP-6532**

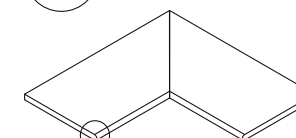

** Canto interior boleado
Bullnose inner corner
Margelle bord intérieur arrondi
Abgerundete Innenecke (Gärung)
Внутренний угол с фаской
Gradino con bordo interno a toro

30x60 Ret. 20mm AS **LP-6720**

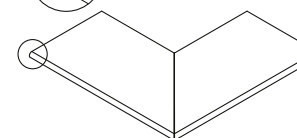

** Canto exterior boleado
Bullnose outer corner
Margelle bord extérieur arrondi
Abgerundete Aussenecke (Gärung)
Внешний угол с фаской
Gradino con bordo esterno a toro

30x60 Ret. 20mm AS **LP-6720**

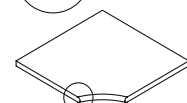

*** Canto interior redondo boleado
Internal corner bullnose
Margelle angle rentrant arrondi
Abgerundete Innenecke
Угол внутренний округлый с фаской
Gradino ad angolo rientrante con toro

40x40 Ret. 20mm AS **LP-6690**

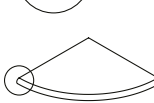

**** Canto exterior redondo boleado
External corner bullnose
Margelle angle sortant arrondi
Abgerundete Aussenecke
Угол внешний округлый с фаской
Gradino ad angolo sporgente con toro

30x30 Ret. 20mm AS **LP-6590**

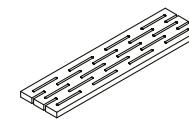

Grelha LT
Overflow grille LT
Grille LT
Überlauf LT
Решетка LT
Griglia LT

15x60 Ret. 20mm AS **LP-6520**

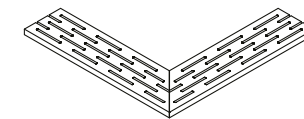

** Canto grelha LT
Overflow corner grille LT
Angle grille LT
Überlauf Ecke LT
Углы решетки LT
Griglia ad angolo LT

15x60 Ret. 20mm AS **LP-6690**

Collections ▾

- Arise
- Avenue
- Balance
- Canyon
- Core
- Genesis
- Gravity
- Ground
- Light
- Marble
- Mémorable
- Metallic
- Native
- Nest
- Precious
- Pulse
- Sense
- Splash
- Timber
- Urban
- Wooden**







Timber Tortora
20 x 100

354

Timber

Collection

DOWNLOAD CATALOGUE  VIEW ONLINE 

 **V2** 
 **R11**  **C**  **>36**
Anti-slip Anti-slip Anti-slip

20 x 100  8 mm

 white	 light beige	 beige
 tortora	 brown	

LOVE
CERAMIC TILES

Index ▾

Colour Map ▾

Collections ▾

- Arise
- Avenue
- Balance
- Canyon
- Core
- Genesis
- Gravity
- Ground
- Light
- Marble
- Mémorable
- Metallic
- Native
- Nest
- Precious
- Pulse
- Sense
- Splash
- Timber**
- Urban
- Wooden

Technical Specifications ▾

Timber

Collection

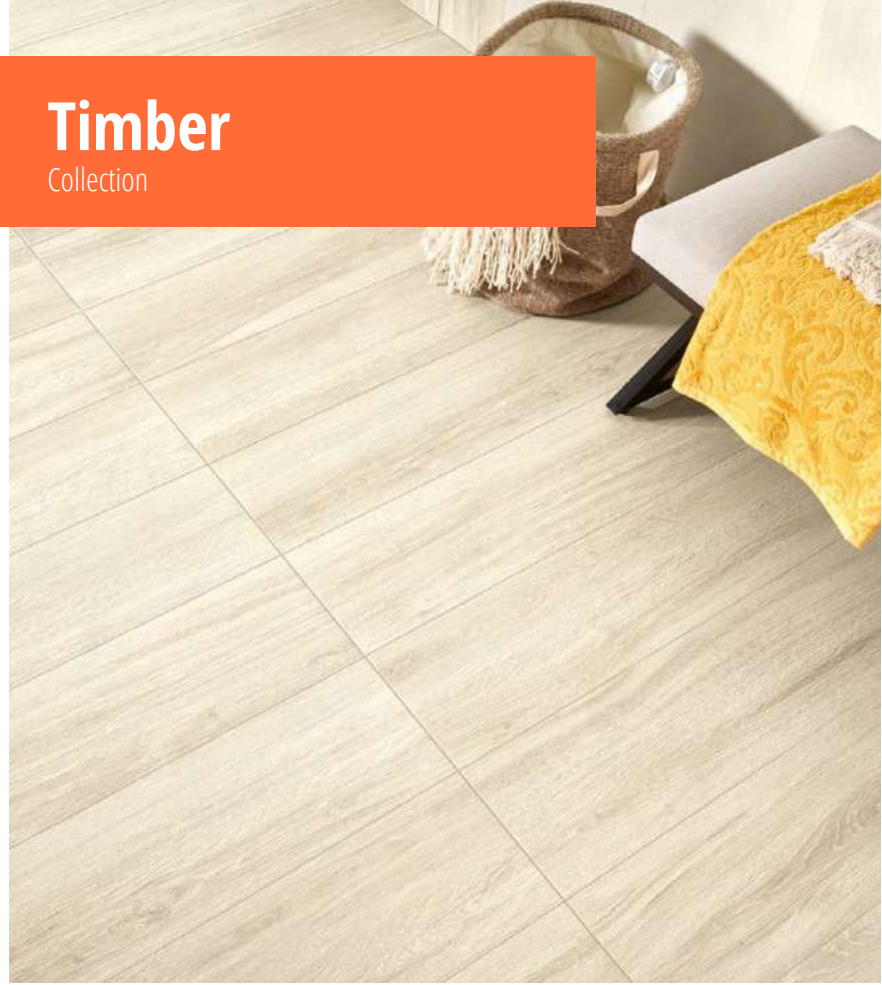

Timber

Collection

[Index](#) ▼

[Colour Map](#) ▼

Collections

- [Arise](#)
- [Avenue](#)
- [Balance](#)
- [Canyon](#)
- [Core](#)
- [Genesis](#)
- [Gravity](#)
- [Ground](#)
- [Light](#)
- [Marble](#)
- [Mémorable](#)
- [Metallic](#)
- [Native](#)
- [Nest](#)
- [Precious](#)
- [Pulse](#)
- [Sense](#)
- [Splash](#)
- [Timber](#)**
- [Urban](#)
- [Wooden](#)

Timber

Collection



Timber

Collection



Index ▼

Colour Map ▼

Collections ▼

- Arise
- Avenue
- Balance
- Canyon
- Core
- Genesis
- Gravity
- Ground
- Light
- Marble
- Mémorable
- Metallic
- Native
- Nest
- Precious
- Pulse
- Sense
- Splash
- Timber**
- Urban
- Wooden

Technical Specifications ▼

Timber

Collection



Timber

Collection

Index ▾

Colour Map ▾

Collections ▾

- Arise
- Avenue
- Balance
- Canyon
- Core
- Genesis
- Gravity
- Ground
- Light
- Marble
- Mémorable
- Metallic
- Native
- Nest
- Precious
- Pulse
- Sense
- Splash
- Timber**
- Urban
- Wooden

Technical Specifications ▾

LOVE
CERAMIC TILES

Timber Beige
20 x 100

Timber Beige
20 x 100 AS



8 mm



TIMBER WHITE
20x100 LT-1270
20x100 AS LT-1300



TIMBER LIGHT BEIGE
20x100 LT-1270
20x100 AS LT-1300



TIMBER BEIGE
20x100 LT-1270
20x100 AS LT-1300



TIMBER TORTORA
20x100 LT-1270
20x100 AS LT-1300



TIMBER BROWN
20x100 LT-1270
20x100 AS LT-1300

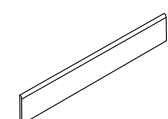

RODAPÉ TIMBER
8x100 LP-6090



8 mm



MOSAIC TIMBER WHITE
20x20 (6,56x6,56) LP-6100

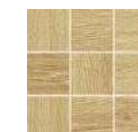

MOSAIC TIMBER LIGHT BEIGE
20x20 (6,56x6,56) LP-6100

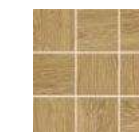

MOSAIC TIMBER BEIGE
20x20 (6,56x6,56) LP-6100

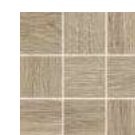

MOSAIC TIMBER TORTORA
20x20 (6,56x6,56) LP-6100

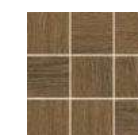

MOSAIC TIMBER BROWN
20x20 (6,56x6,56) LP-6100

SUGESTÕES DE APLICAÇÃO | LAYING SUGGESTIONS | SUGGESTIONS DE POSE | ANWENDUNGSVORSCHLÄGE | СОВЕТЫ ПО УКЛАДКЕ | SUGGERIMENTI DI POSA

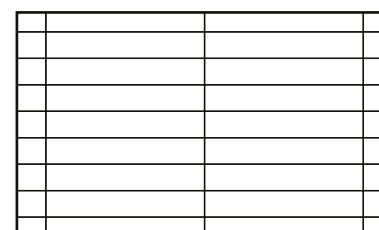

Pág 356 - 357

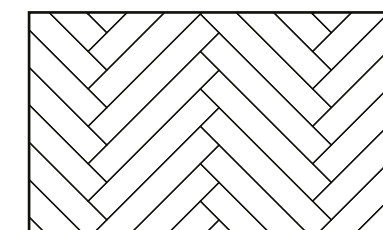

Pág 358 - 359

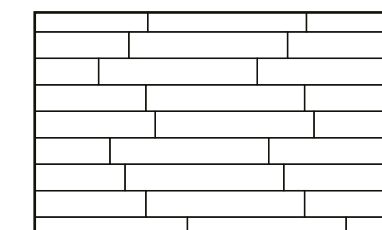

Pág 360 - 361

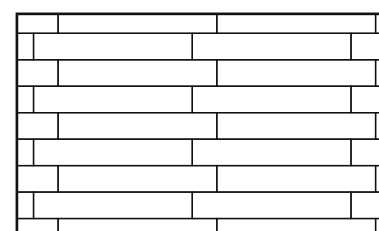

Pág 354 - 355

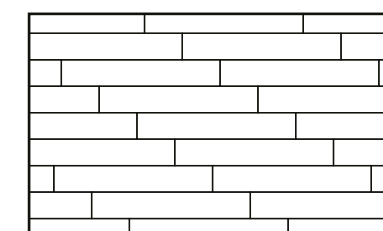

Pág 358 - 359

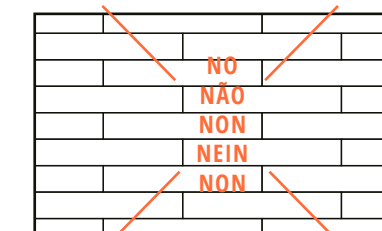

- Arise
- Avenue
- Balance
- Canyon
- Core
- Genesis
- Gravity
- Ground
- Light
- Marble
- Mémorable
- Metallic
- Native
- Nest
- Precious
- Pulse
- Sense
- Splash
- Timber**
- Urban
- Wooden



Avenue 20mm Dark Grey
60 x 90 Ret. AS

364

Avenue

Collection

VIEW ONLINE 

Index ▾

Colour Map ▾

Collections ▾

- Arise
- Avenue**
- Balance
- Canyon
- Core
- Genesis
- Gravity
- Ground
- Light
- Marble
- Mémorable
- Metallic
- Native
- Nest
- Precious
- Pulse
- Sense
- Splash
- Timber
- Urban
- Wooden





60 x 60 · 60 x 90 



tortora grey dark grey

LOVE
CERAMIC TILES

Technical Specifications ▾

Avenue

Collection



Avenue

Collection

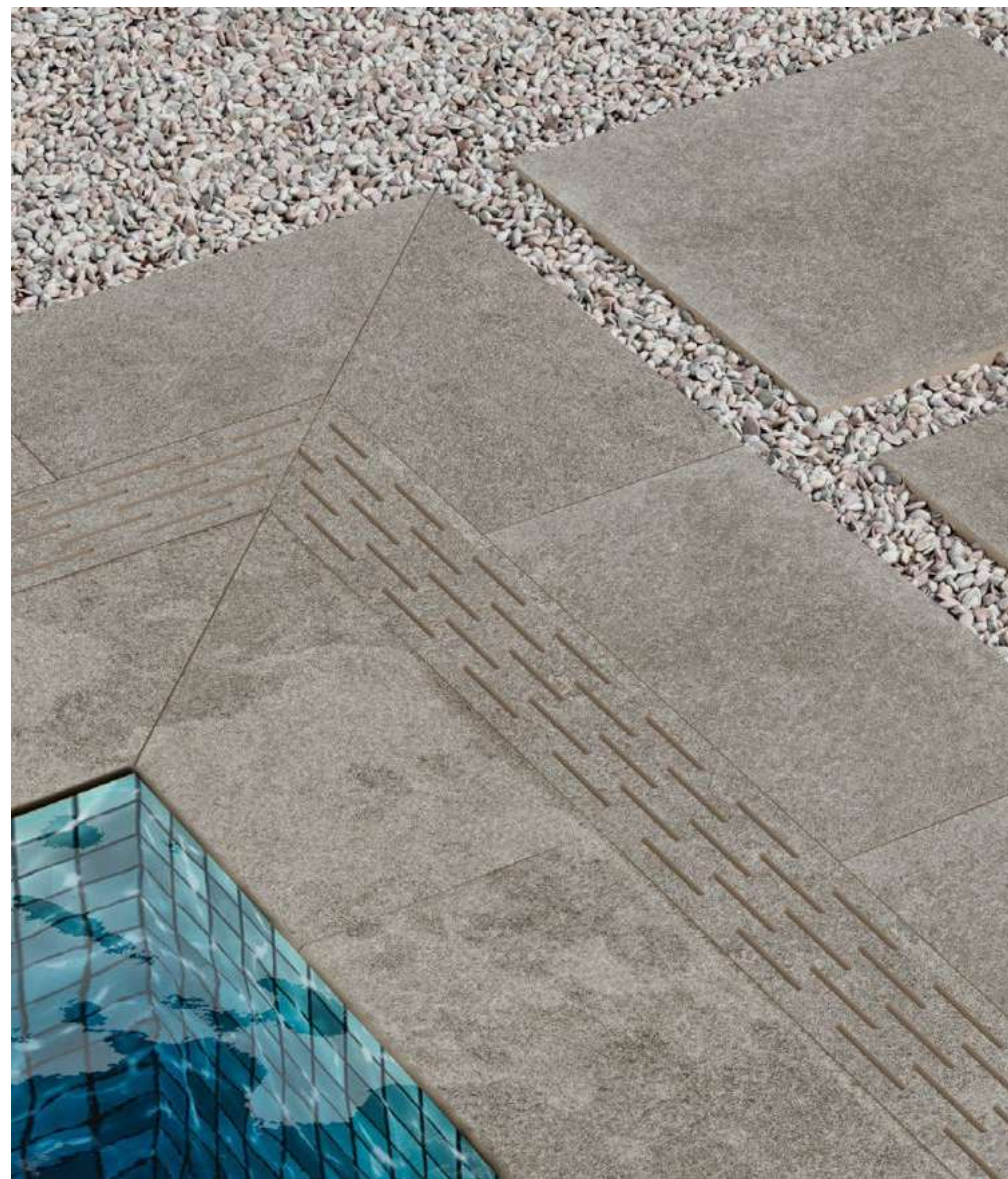

[Index](#) ▼

[Colour Map](#) ▼

Collections

[Arise](#)

[Avenue](#)

[Balance](#)

[Canyon](#)

[Core](#)

[Genesis](#)

[Gravity](#)

[Ground](#)

[Light](#)

[Marble](#)

[Mémorable](#)

[Metallic](#)

[Native](#)

[Nest](#)

[Precious](#)

[Pulse](#)

[Sense](#)

[Splash](#)

[Timber](#)

[Urban](#)

[Wooden](#)

[Technical Specifications](#) ▼



20 mm



AVENUE 20MM TORTORA
60x90 Ret. AS **LT-3800**



AVENUE 20MM TORTORA
60x60 AS **LT-3570**
60x60 Ret. AS **LT-3600**



AVENUE 20MM GREY
60x90 Ret. AS **LT-3800**



AVENUE 20MM GREY
60x60 AS **LT-3570**
60x60 Ret. AS **LT-3600**



AVENUE 20MM DARK GREY
60x90 Ret. AS **LT-3800**



AVENUE 20MM DARK GREY
60x60 AS **LT-3570**
60x60 Ret. AS **LT-3600**

OUTDOOR
EXTRA THICK

PEÇAS ESPECIAIS | SPECIAL PIECES | PIÈCES SPÉCIALES | SPEZIALTEILE | СПЕЦИАЛЬНЫЕ ИЗДЕЛИЯ | PEZZI SPECIALI



20 mm

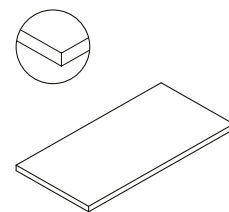

Base
Straight edge
Margelle
Stufenplatte
Ступень базовая
Gradino costa retta

30x60 20mm AS **LP-6340**
30x60 Ret. 20mm AS **LP-6435**

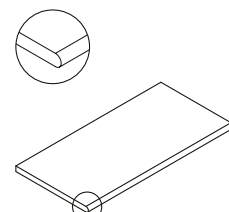

Base boleada
Bullnose
Margelle arredie
Stufenplatte abgerundet
Ступень с закругленной фаской
Gradino costa toro

30x60 20mm AS **LP-6525**
30x60 Ret. 20mm AS **LP-6585**

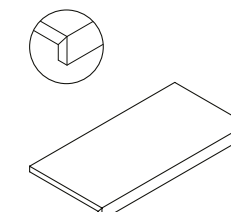

Degrau Espessurado 20mm
Step extra thick 20mm
Nez de marche forte épaisseur 20mm
Massive stufenplatte 20mm
Ступень утолщенная 20mm
Gradino spessorato 20mm

30x60 Ret. 20mm AS **LP-6590**
30x90 Ret. 20mm AS **LP-6630**

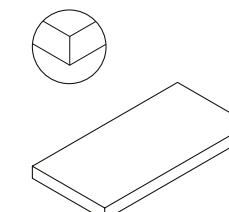

* Degrau Espessurado 20mm Canto
Step extra thick 20mm corner
Nez de marche forte épaisseur 20mm angle
Ecke massive stufenplatte 20mm
Угловая ступень утолщенная 20mm
Angolo gradino spessorato 20mm

30x60 Ret. 20mm AS **LP-6660**
30x90 Ret. 20mm AS **LP-6690**

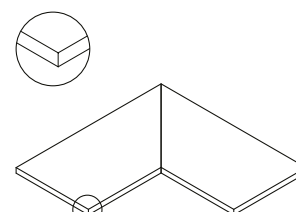

** Canto interior
Straight edge inner corner
Margelle angle bord droit intérieur
Eckstufe
Внутренний угол
Angolo interno

30x60 20mm AS **LP-6470**
30x60 Ret. 20mm AS **LP-6532**

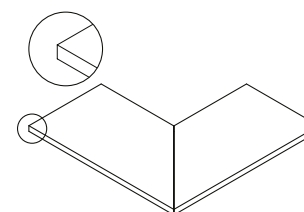

** Canto exterior
Straight edge outer corner
Margelle angle bord droit extérieur
Eckstufe Außenseite
Внешний угол
Angolo esterno

30x60 20mm AS **LP-6470**
30x60 Ret. 20mm AS **LP-6532**

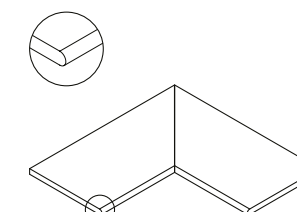

** Canto interior boleado
Bullnose inner corner
Margelle bord intérieur arrondi
Abgerundete Innenecke (Gärung)
Внутренний угол с фаской
Gradino con bordo interno a toro

30x60 20mm AS **LP-6660**
30x60 Ret. 20mm AS **LP-6720**

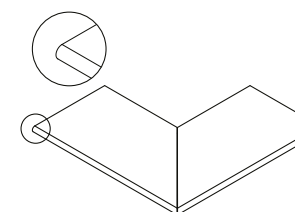

** Canto exterior boleado
Bullnose outer corner
Margelle bord extérieur arrondi
Abgerundete Aussenecke (Gärung)
Внешний угол с фаской
Gradino con bordo esterno a toro

30x60 20mm AS **LP-6660**
30x60 Ret. 20mm AS **LP-6720**

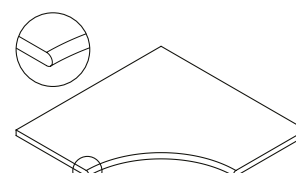

*** Canto interior redondo boleado
Internal corner bullnose
Margelle angle rentrant arrondi
Abgerundete Innenecke
Угол внутренний округлый с фаской
Gradino ad angolo rientrante con toro

60x60 20mm AS **LP-6690**
60x60 Ret. 20mm AS **LP-6690**

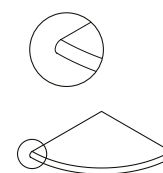

*** Canto exterior redondo boleado
External corner bullnose
Margelle angle sortant arrondi
Abgerundete Aussenecke
Угол внешний округлый с фаской
Gradino ad angolo sporgente con toro

30x30 20mm AS **LP-6590**
30x30 Ret. 20mm AS **LP-6590**

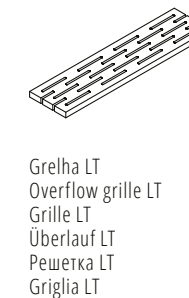

Grelha LT
Overflow grille LT
Grille LT
Überlauf LT
Решетка LT
Griglia LT

15x60 20mm AS **LP-6520**
15x60 Ret. 20mm AS **LP-6520**

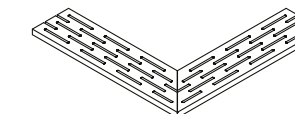

** Canto grelha LT
Overflow corner grille LT
Angle grille LT
Überlauf Ecke LT
Углы решетки LT
Griglia ad angolo LT

15x60 20mm AS **LP-6690**
15x60 Ret. 20mm AS **LP-6690**

*Disponível no canto direito e esquerdo - Available in right and left corner - Disponible dans les coin droit et gauche
Erhältlich in der rechten Ecke und links - Доступна как правая так и левая угловая ступень - Disponibile nell'angolo destro e sinistro

** Vendida ao par - Sold per two pieces set - Vendu à la paire
* Paarweise verkauft - Продаётся в комплекте состоящим из двух штук - Venduta a coppie

*** Raio - Radius - Rayon - Radius - Radius - Радиус LT: 30cm

- Arise
- Avenue**
- Balance
- Canyon
- Core
- Genesis
- Gravity
- Ground
- Light
- Marble
- Mémorable
- Metallic
- Native
- Nest
- Precious
- Pulse
- Sense
- Splash
- Timber
- Urban
- Wooden



Canyon

Collection

DOWNLOAD CATALOGUE  VIEW ONLINE 

Index ▾

Colour Map ▾

Collections ▾

- Arise
- Avenue
- Balance
- Canyon**
- Core
- Genesis
- Gravity
- Ground
- Light
- Marble
- Mémorable
- Metallic
- Native
- Nest
- Precious
- Pulse
- Sense
- Splash
- Timber
- Urban
- Wooden





60 x 60 · 60 x 90 

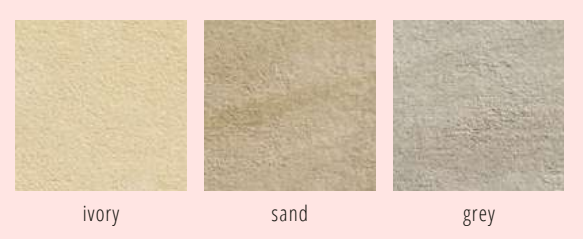

Canyon 20mm Grey
60 x 90 Ret. AS

370



Technical Specifications ▾



20 mm



CANYON 20MM IVORY
60x90 Ret. AS **LT-3800**



CANYON 20MM IVORY
60x60 AS **LT-3570**
60x60 Ret. AS **LT-3600**



CANYON 20MM SAND
60x90 Ret. AS **LT-3800**



CANYON 20MM SAND
60x60 AS **LT-3570**
60x60 Ret. AS **LT-3600**



CANYON 20MM GREY
60x90 Ret. AS **LT-3800**



CANYON 20MM GREY
60x60 AS **LT-3570**
60x60 Ret. AS **LT-3600**

OUTDOOR
EXTRA THICK

PEÇAS ESPECIAIS | SPECIAL PIECES | PIÈCES SPÉCIALES | SPEZIALTEILE | СПЕЦИАЛЬНЫЕ ИЗДЕЛИЯ | PEZZI SPECIALI



20 mm

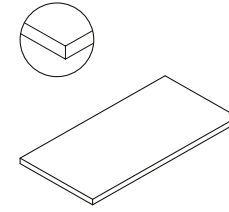

Base
Straight edge
Margelle
Stufenplatte
Ступень базовая
Gradino costa retta

30x60 20mm AS **LP-6340**
30x60 Ret. 20mm AS **LP-6435**

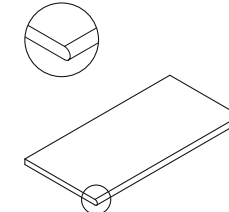

Base boleada
Bullnose
Margelle arredie
Stufenplatte abgerundet
Ступень с закругленной фаской
Gradino costa toro

30x60 20mm AS **LP-6525**
30x60 Ret. 20mm AS **LP-6585**

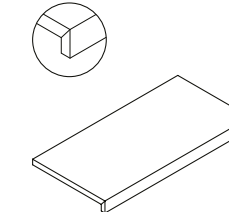

Degrau Espessurado 20mm
Step extra thick 20mm
Nez de marche forte épaisseur 20mm
Massive stufenplatte 20mm
Ступень утолщенная 20mm
Gradino spessorato 20mm

30x60 Ret. 20mm AS **LP-6590**
30x90 Ret. 20mm AS **LP-6630**

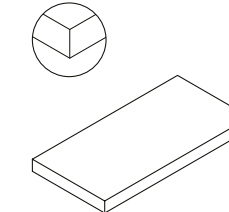

* Degrau Espessurado 20mm Canto
Step extra thick 20mm corner
Nez de marche forte épaisseur 20mm angle
Ecke massive stufenplatte 20mm
Угловая ступень утолщенная 20mm
Angolo gradino spessorato 20mm

30x60 Ret. 20mm AS **LP-6660**
30x90 Ret. 20mm AS **LP-6690**

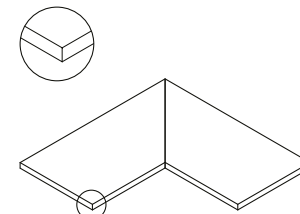

** Canto interior
Straight edge inner corner
Margelle angle bord droit intérieur
Eckstufe
Внутренний угол
Angolo interno

30x60 20mm AS **LP-6470**
30x60 Ret. 20mm AS **LP-6532**

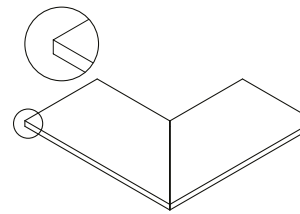

** Canto exterior
Straight edge outer corner
Margelle angle bord droit extérieur
Eckstufe Außenseite
Внешний угол
Angolo esterno

30x60 20mm AS **LP-6470**
30x60 Ret. 20mm AS **LP-6532**

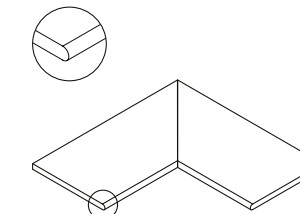

** Canto interior boleado
Bullnose inner corner
Margelle bord intérieur arrondi
Abgerundete Innenecke (Gärung)
Внутренний угол с фаской
Gradino con bordo interno a toro

30x60 20mm AS **LP-6660**
30x60 Ret. 20mm AS **LP-6720**

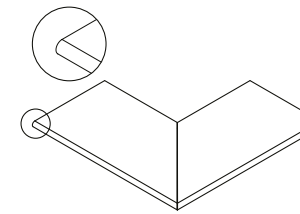

** Canto exterior boleado
Bullnose outer corner
Margelle bord extérieur arrondi
Abgerundete Aussenecke (Gärung)
Внешний угол с фаской
Gradino con bordo esterno a toro

30x60 20mm AS **LP-6660**
30x60 Ret. 20mm AS **LP-6720**

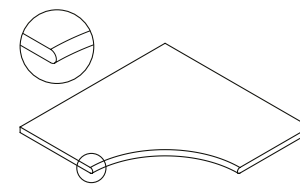

*** Canto interior redondo boleado
Internal corner bullnose
Margelle angle rentrant arrondi
Abgerundete Innenecke
Угол внутренний округлый с фаской
Gradino ad angolo rientrante con toro

60x60 20mm AS **LP-6690**
60x60 Ret. 20mm AS **LP-6690**

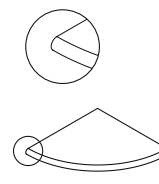

*** Canto exterior redondo boleado
External corner bullnose
Margelle angle sortant arrondi
Abgerundete Aussenecke
Угол внешний округлый с фаской
Gradino ad angolo sporgente con toro

30x30 20mm AS **LP-6590**
30x30 Ret. 20mm AS **LP-6590**

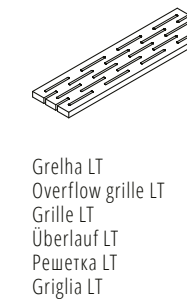

Grelha LT
Overflow grille LT
Grille LT
Überlauf LT
Решетка LT
Griglia LT

15x60 20mm AS **LP-6520**
15x60 Ret. 20mm AS **LP-6520**

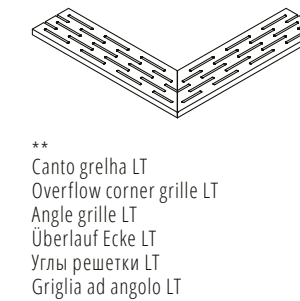

** Canto grelha LT
Overflow corner grille LT
Angle grille LT
Überlauf Ecke LT
Углы решетки LT
Griglia ad angolo LT

15x60 20mm AS **LP-6690**
15x60 Ret. 20mm AS **LP-6690**

* Disponível no canto direito e esquerdo - Available in right and left corner - Disponible dans les coin droit et gauche
Erhältlich in der rechten Ecke und links - Доступна как правая так и левая угловая ступень - Disponibile nell'angolo destro e sinistro

** Vendida ao par - Sold per two pieces set - Vendu à la paire
* Paarweise verkauft - Продаётся в комплекте состоящим из двух штук - Venduta a coppie

*** Raio - Radius - Rayon - Radius - Radius - Радиус: 30cm

- Arise
- Avenue
- Balance
- Canyon**
- Core
- Genesis
- Gravity
- Ground
- Light
- Marble
- Mémorable
- Metallic
- Native
- Nest
- Precious
- Pulse
- Sense
- Splash
- Timber
- Urban
- Wooden



AÇÃO POTENTE

Elimina até 99,9% das bactérias e impede a sua reprodução

POWERFUL ACTION

Eliminates up to 99.9% of bacteria and prevents their reproduction

ACTION PUissante

Élimine jusqu'à 99,9% des bactéries et empêche leur prolifération

LEISTUNGSSTARKE WIRKUNG

Eliminiert bis zu 99,9% Bakterien und ihre Verbreitung verhindern

МОЩНОЕ ДЕЙСТВИЕ

Уничтожает до 99,9% бактерий и предотвращает их размножение

AZIONE POTENTE

Elimina fino al 99,9% di batteri e impedisce la proliferazione



PROTEÇÃO CONTÍNUA

Permanente ativo, 24 horas por dia, com ou sem luz solar

CONTINUOUS PROTECTION

Always active, 24 hours a day, with or without sunlight

PROTECTION CONTINUE

Toujours actif, 24 heures sur 24 avec ou sans lumière naturelle

DAUERSCHUTZ

immer aktiv, Rund um die Uhr, mit oder ohne Sonnenlicht

НЕПРЕРЫВНАЯ ЗАЩИТА

Всегда активна, 24 часа в сутки, с солнечным светом или без него

PROTEZIONE CONTINUA

24 ore su 24, con e senza luce solare



EFICÁCIA PERMANENTE

Graças à tecnologia incorporada no produto

ETERNAL EFFECTIVENESS

Thanks to technology integrated into the product

EFFICACITÉ PERMANENTE

Grâce à la technologie intégrée dans le produit

DAUERHAFT WIRKSAMKEIT

Dank der im Produkt integrierten Technologie

ПОСТОЯННАЯ ЭФФЕКТИВНОСТЬ

Благодаря технологии, интегрированной в продукт

EFFICACIA ETERNA

Grazie alla tecnologia integrata nel prodotto



QUALIDADE GARANTIDA

Em parceria com a Microban®

GUARANTEED QUALITY

By the partnership with Microban®

QUALITÉ GARANTIE

En partenariat avec Microban®

GARANTIERTE QUALITÄT

Dank der Partnership mit Microban®

GARANTIROVANNOE KACHESTVO

Благодаря партнерству с Microban®

QUALITÀ GARANTITA

Dalla partnership con Microban®

O LOCAL MAIS SEGURO DO MUNDO

Ação antibacteriana ativa contínua

– Escolhemos a Microban®, líder global em tecnologia antibacteriana, para tornar os produtos cerâmicos ainda mais seguros.

– Há mais bactérias numa mão do que pessoas na Terra.

– O crescimento bacteriano pode duplicar de número a cada 20 minutos em superfícies não protegidas.

Os pavimentos de áreas com elevados níveis de tráfego pedestre, tais como escolas, escritórios, hospitais e edifícios públicos são locais ideais para o crescimento microbiano e bacteriano, mas as nossas casas, apesar da limpeza diária, também podem ser contaminadas por germes e bactérias vindas do exterior.

Atualmente, graças ao trabalho contínuo no Panariagroup Research Centre e a um acordo prestigiado com a Microban®, líder global em tecnologia antibacteriana, temos o orgulho de anunciar a linha PROTECT®. Produzidos com a tecnologia Microban®, os pavimentos e revestimentos da Love Tiles estão protegidos por uma barreira antibacteriana inovadora que elimina até 99,9% das bactérias na superfície e garante uma proteção duradoura contra o desgaste, condições climáticas e limpezas repetidas em qualquer ambiente.

A tecnologia de prata Microban foi registada junto da Diretiva de Produtos Biocidas (BPD, Biocidal Product Directive), sob os tipos de produto adequados conforme requerido pela Diretiva de Produtos Biocidas da UE, 98/8/CE.

Além disso, a tecnologia Microban® está ativa 24 horas por dia, garantindo proteção contínua dia e noite, mantendo os mosaicos mais higiénicos entre limpezas.

L'ENDROIT LE PLUS SÛR AU MONDE

Action antibactérienne active en permanence

– Nous avons choisi Microban®, le leader mondial en technologie antibactérienne, pour rendre nos carrelages encore plus sûrs.

– Il y a plus de bactéries sur une main que d'habitants sur la terre

– Sur les surfaces non protégées, la prolifération des bactéries peut se multiplier par deux toutes les 20 minutes.

Les sols des zones à hauts niveaux de trafic des piétons, comme par exemple, les écoles, bureaux, hôpitaux et bâtiments publics, sont des endroits qui se prêtent à la prolifération microbienne et bactérienne, mais, malgré un nettoyage quotidien, nos foyers peuvent aussi être contaminés par des germes et des bactéries venant de l'extérieur.

À l'heure actuelle, grâce aux travaux continus du Panariagroup Research Centre, et à un contrat prestigieux avec Microban®, le leader mondial en technologie antibactérienne, nous sommes fiers d'annoncer la ligne PROTECT®. La gamme Love Tiles, produits en incorporant la technologie Microban®, sont protégés par un bouclier antibactérien innovateur qui élimine jusqu'à 99,9% des bactéries sur les surfaces et garantit une protection durable contre l'usure, les conditions climatiques et les nettoyages à répétition dans tous les lieux d'utilisation.

La technologie à base d'argent Microban est notifiée avec la Directive sur les produits biocides (Biocidal Products Directive, BPD) sous les types de produits appropriés tel que requis par la Directive européenne sur les produits biocides, 98/8/EC.

Par ailleurs, la technologie Microban® reste active 24 heures par jour, ce qui garantit une protection ininterrompue jour et nuit, maintenant les carrelages dans un état plus hygiénique entre les nettoyages.

САМОЕ БЕЗОПАСНОЕ МЕСТО В МИРЕ

Постоянное эффективное антибактериальное действие

– Чтобы сделать нашу плитку еще безопаснее, мы используем продукцию компании Microban® — мирового лидера в области антибактериальных технологий.

– На ладони одной руки больше бактерий, чем людей на всей планете.

– На незащищенных поверхностях количество бактерий может удваиваться каждые 20 минут.

Полы в местах с интенсивным пешеходным движением, например, в школах, больницах, административных и общественных зданиях, идеально подходят для размножения микробов и бактерий. Несмотря на ежедневную уборку, наши жилища также подвергаются нашествию микробов и бактерий извне.

Сегодня мы с гордостью сообщаем, что благодаря плодотворной деятельности Исследовательского центра Panariagroup и подписанию соглашения с мировым лидером в области антибактериальных технологий, компанией Microban®, мы запускаем новую линейку PROTECT®. Изготовленные по технологии Microban®, напольные и настенные покрытия Love Tiles защищены инновационным антибактериальным покрытием, которое устраняет до 99,9% бактерий на поверхности и обеспечивает длительную защиту от износа, погодных условий и регулярной уборки в любых условиях эксплуатации.

Технология на основе серебра Microban была зарегистрирована Директивой о бицидных продуктах (BPD) для соответствующих типов продуктов, как того требует Директива ЕС по бицидным продуктам, 98/8/EC.

Кроме того, действуя 24 часа в сутки, технология Microban® гарантирует непрерывную защиту плитки днем и ночью, а также поддерживает гигиену в период между уборками.



THE SAFEST PLACE IN THE WORLD

Continuous active antibacterial action

– We have chosen Microban®, the global leader in antibacterial technology, to make our tiles even safer.

– There are more bacteria on one hand than people on the Earth.

– Bacterial growth can double in number every 20 minutes on unprotected surfaces.

Floors in areas with high levels of pedestrian traffic, such as schools, offices, hospitals and public buildings are ideal places for microbial and bacterial growth, but our homes, despite daily cleaning, can also be contaminated by germs and bacteria from outside.

Today, thanks to ongoing work at the Panariagroup Research Centre and a prestigious agreement with the global leader in antibacterial technology Microban®, we are proud to announce PROTECT® line. Love Tiles products, produced with Microban® technology, are protected by an innovative antibacterial shield that eliminates up to 99.9% of bacteria on surfaces and guarantees long-lasting protection against wear and tear, climatic conditions and repeated cleans in any usage environment.

Microban silver technology is notified with the Biocidal Products Directive (BPD) under the appropriate product types as required by the EU Biocidal Products Directive, 98/8/EC.

In addition, Microban® technology is active 24 hours a day, guaranteeing continuous protection day and night, keeping tiles more hygienic in between cleans.

DER SICHERSTE ORT DER WELT

Die aktive antibakterielle Aktion geht weiter

– Wir haben uns für Microban®, den Weltmarktführer in antibakterieller Technologie entschieden, um unsere Mosaik noch sicherer zu machen.

– In der Fläche einer Hand leben mehr Bakterien als Menschen auf der Erde.

– Bakteriell Wachstum kann sich auf ungeschützten Oberflächen alle 20 Minuten verdoppeln.

Fußböden in Bereichen mit hohem Fußgängeraufkommen wie Schulen, Büros, Krankenhäusern und öffentlichen Gebäuden sind ideale Orte für mikrobielles und bakterielles Wachstum, und sogar unsere Wohnungen können trotz täglicher Reinigung durch Erreger und Bakterien von außen verseucht sein.

Heute geben wir, dank der andauernden Forschungsarbeit des Panariagroup Research Centre und einem Übereinkommen mit Microban®, dem Weltmarktführer in antibakterieller Technologie unsere neue „PROTECT® -Reihe“ bekannt. Die anhand der Microban®-Technologie gefertigten Love Tiles -Mosaik durch eine innovative antibakterielle Barriere geschützt, die bis zu 99,9% der Bakterien an der Oberfläche eliminiert und einen dauerhaften Schutz gegen Abnutzung, Witterung und wiederholte Reinigung in jeglichem Einsatzumfeld bietet.

Die Microban Silbertechnologie wurde gemäß der Anforderungen der EU-Richtlinie für Biozid-Produkte (98/8/CE) unter dem Schutz der Richtlinie für Biozid-Produkte (BPD, Biocidal Product Directive) registriert.

Außerdem ist die Microban®-Technologie 24 Stunden am Tag aktiv und garantiert auf diese Weise Tag- und Nachtschutz, indem sie die Mosaik zwischen den Putzvorgängen hygienisch hält.

IL POSTO PIÙ SICURO AL MONDO

Azione antibatterica attiva continua

– Abbiamo scelto Microban®, leader mondiale nella tecnologia antibatterica, per rendere ancora più sicure le nostre piastrelle.

– Ci sono più batteri su una mano che abitanti sulla Terra.

– Sulle superfici non protette la crescita batterica può raddoppiare ogni 20 minuti.

I pavimenti di zone ad alto calpestio come scuole, uffici, ospedali e locali pubblici possono rappresentare luoghi ideali per la crescita di microbi e batteri, ma anche la nostra casa, nonostante la pulizia quotidiana, può essere contaminata da germi e batteri provenienti dall'esterno.

Oggi, grazie al costante lavoro del Centro Ricerche Panariagroup e ad un prestigioso accordo con Microban®, leader mondiale nella tecnologia antibatterica, siamo orgogliosi di annunciare la linea PROTECT®. I prodotti Love Tiles, realizzati con la tecnologia Microban®, sono protette da un innovativo scudo antibatterico che elimina fino al 99,9% dei batteri dalla superficie e assicura una protezione duratura contro l'usura, gli agenti atmosferici e la pulizia ripetuta in qualsiasi ambiente di utilizzo.

La tecnologia Microban a base di argento è registrata ai sensi della direttiva sui biocidi (BPD, Biocidal Product Directive) nell'ambito dei tipi di prodotto appropriati, come richiesto dalla direttiva UE sui biocidi 98/8/CE.

Inoltre, la tecnologia Microban® rimane attiva 24 ore su 24, garantendo una protezione continua giorno e notte, mantenendo le piastrelle più pulite fra una pulizia e l'altra.

Certificação

Certification | Certification | Zertifizierung | Сертификация | Certificazione



HABITAR O PRESENTE VIVER O FUTURO

A Love Tiles cria coleções cerâmicas para habitar o presente e o futuro, plenas de beleza, dotadas de qualidade de um design exclusivo. A mesma beleza e a mesma harmonia que sonhamos para o mundo em nosso redor. Para isso a Love Tiles cria e protege, reduzindo ao mínimo o impacto ambiental da sua atividade, por meio da constante pesquisa da eco sustentabilidade no local de trabalho, nas matérias utilizadas e nos processos produtivos, como demonstram as certificações ambientais obtidas.

Queremos contribuir para que vivamos num mundo melhor, sabendo que a eco sustentabilidade é desenvolvimento olhando para o futuro...

Este é o nosso esforço quotidiano e a nossa responsabilidade social.

INHABIT THE PRESENT LIVE THE FUTURE

Love Tiles creates ceramic collections to live the present and the future, surrounded by beauty, protected by the quality of an exclusive design of living in total freedom. The same beauty and marvelous harmony that we dream for the world around us. For this, Love Tiles creates and protects, by reducing to its minimum the environmental impact coming from its activity, through the constant research of the total eco-sustainability in the working environment, on the materials used and in the productive processes, as the obtained environmental certificates demonstrate.

We want to contribute for a better world and only what is really eco-sustainable can be considered as development with future vision...

This is our daily commitment and our social responsibility.

HABITER LE PRÉSENT VIVRE L'AVENIR

Love Tiles crée des collections pour vivre le présent et l'avenir, entourées par la beauté, protégées de la qualité d'un design exclusif à vivre en toute liberté. La même beauté et la même harmonie dont nous rêvons pour notre monde. C'est pour cette raison que Love Tiles crée et protège en réduisant au maximum l'impact environnemental de son activité, grâce à la permanente recherche de l'équilibre écologique dans l'environnement de travail, dans les matières utilisées et dans le processus productif, comme le démontre les certifications environnementales obtenues.

Nous voulons contribuer à ce que vous viviez dans un monde plus beau, plus écologique donc plus développé et orienté vers l'avenir. Ceci est notre engagement quotidien et notre responsabilité sociale.

WOHNEN IN DER GEGENWART UND DIE ZUKUNFT ERLEBEN

Love Tiles kreiert Keramikkollektionen mit dem Konzept "wohnen in der gegenwart und die zukunft erleben". Diese Kollektionen zeichnet eine außergewöhnliche Schönheit, höchste Qualität und exklusives Design aus. Dasselbe Schönheit und Harmonie, die wir uns für die Welt in unserem Umkreis erträumen. Danach richtet Love Tiles ihre Produktion aus: Für die Herstellung benutzen wir umweltschonende Verfahren, m.a.W. die Umwelt auswirkungen sind auf das Mindestmaß reduziert. Die gelingt uns durch konstante Forschungsarbeiten auf dem Gebiet der Öko-Nachhaltigkeit am Arbeitsplatz, bei den verwendeten Materialien und bei den Herstellungsverfahren. Davon zeugen die Umweltzertifikate, mit denen wir ausgezeichnet wurden.

Wir möchten einen Beitrag für eine bessere Welt leisten, wohl wissend, dass die Öko-Nachhaltigkeit Entwicklung in die Zukunft bedeutet.

Dies ist unser alltägliches Anliegen und unsere soziale Verantwortung.

ЖИТЬ В НАСТОЯЩЕМ И БУДУЩЕМ

Love Tiles создает керамические коллекции, чтобы жить настоящим и будущим, в окружении красоты эксклюзивного дизайна, защищенные качеством, созданные для жизни в полной свободе. Та же красота и изумительная гармония, о которых мы мечтаем, для мира вокруг нас.

Love Tiles создает свою продукцию и в то же время защищает природу, сводя к минимуму воздействие на окружающую среду, путем постоянного модернизирования и исследования используемых материалов и производственных процессов, наглядно это демонстрируют экологические сертификаты. Мы хотим внести свой вклад в лучший мир, и только то, что действительно eco-friendly, можно рассматривать как развитие с перспективой на будущее ... Это наша повседневная обязанность и наша социальная ответственность

ABITARE IL PRESENTE VIVERE IL FUTURO

Love Tiles crea collezioni ceramiche per abitare il presente e il futuro, piene di bellezza, con la qualità di un design unico. La stessa bellezza e armonia che sogniamo per il mondo che ci circonda. Per questa ragione Love Tiles crea e protegge, riducendo al minimo l'impatto ambientale delle proprie attività, attraverso la costante ricerca dell'ecosostenibilità sul posto di lavoro, nei materiali utilizzati e nei processi produttivi, come dimostrato dalle certificazioni ambientali ottenute.

Vogliamo contribuire a costruire un mondo migliore, sapendo che l'ecosostenibilità è sviluppo con uno sguardo al futuro.

Questo è il nostro sforzo quotidiano e la nostra responsabilità sociale.



A marca GREENGUARD certifica produtos que garantem os mais elevados padrões de qualidade do ar em espaços interiores.

Todas as coleções LOVE TILES em grés porcelânico, monoporosa e grés laminado obtiveram a certificação GREENGUARD GOLD, ou seja, a norma UL com os mais rigorosos limites relativos às emissões de COV (Compostos Orgânicos Voláteis), estando, assim, em condições de garantir as melhores condições de salubridade às pessoas que vivem e habitam espaços interiores. Por conseguinte, podem ser utilizadas em ambientes como escolas e estabelecimentos de saúde, frequentados por pessoas sensíveis, como crianças e idosos.

A GREENGUARD GOLD é uma certificação amplamente reconhecida e exigida pelos programas de construção sustentável e pelos regulamentos de projeto e construção em todo o mundo, tais como o LEED (internacional) e o BREEAM (Reino Unido).

The GREENGUARD brand certifies products that guarantee the highest standards of indoor air quality.

All LOVE TILES collections in porcelain stoneware, monoporous and laminated stoneware have obtained the GREENGUARD GOLD certification, that is, the UL standard with the strictest limits on VOC (Volatile Organic Compounds) emissions, thus being in a position to guarantee the best health conditions for people who live and dwell in indoor spaces. Therefore, they can be used in environments such as schools and healthcare facilities, frequented by sensitive people, such as children and the elderly.

GREENGUARD GOLD is a widely recognised certification, required by sustainable construction programmes and by design and construction regulations around the world, such as LEED (international) and BREEAM (UK).

La marque GREENGUARD certifie des produits qui garantissent les plus hauts standards de qualité de l'air dans les espaces intérieurs.

Toutes les collections LOVE TILES en grés cérame, monoporouse et grés laminé ont obtenu la certification GREENGUARD GOLD, c'est-à-dire, la norme UL avec les limites les plus strictes d'émissions de COV (composés organiques volatils), étant ainsi en mesure de garantir les meilleures conditions sanitaires aux personnes qui vivent et habitent les espaces intérieurs. Ils peuvent donc être utilisés dans des environnements tels que les écoles et les établissements de santé, fréquentés par des personnes sensibles, comme les enfants et les personnes âgées.

GREENGUARD GOLD est une certification largement reconnue et exigée par les programmes de construction durable et les réglementations de conception et de construction dans le monde entier, telles que LEED (international) et BREEAM (Royaume-Uni).



Certificação

Certification | Certification | Zertifizierung | Сертификация | Certificazione

Index ▾

Colour Map ▾

Collections ▾

Technical Specifications ▾

Calibers

Certification

General Sales Conditions

Laying Suggestions

Outdoor extra thick

Package

Pr(ect

Symbols

Technical Information

Die Marke GREENGUARD zertifiziert Produkte, die die höchsten Standards der Luftqualität in Innenräumen garantieren.

Alle LOVE TILES-Kollektionen aus Feinsteinzeug, Monoporös und laminiertem Feinsteinzeug haben die GREENGUARD GOLD-Zertifizierung erhalten, d.h. die UL-Norm mit den strengsten Grenzwerten für FOV-Emissionen (Flüchtiger Organischer Verbindungen) und sind somit in der Lage, die besten Gesundheitsbedingungen für Menschen, die in Innenräumen leben und wohnen, zu gewährleisten. Daher, können sie in Umgebungen wie Schulen und Gesundheitseinrichtungen eingesetzt werden, die von empfindlichen Menschen wie Kindern und älteren Menschen frequentiert werden.

GREENGUARD GOLD ist eine Zertifizierung, die weithin anerkannt und von nachhaltigen Bauprogrammen und Design- und Bauvorschriften auf der ganzen Welt gefordert wird, wie LEED (international) und BREEAM (UK).

Марка GREENGUARD сертифицирует продукцию, которая гарантирует самые высокие стандарты качества воздуха в помещениях.

Все коллекции керамогранита, монопористого и ламинированного керамогранита LOVE TILES были сертифицированы GREENGUARD GOLD, то есть стандартом UL, с самыми строгими ограничениями на выбросы ЛОС (летучих органических соединений), что позволяет гарантировать наилучшее состояние здоровья людей, которые проживают или посещают внутренние пространства населенных пунктов. Поэтому данные материалы можно использовать в таких местах, как школы и медицинские учреждения, где могут присутствовать такие чувствительные люди, как дети и пожилые люди.

GREENGUARD GOLD является широко признанной сертификацией и требуется программами самообеспеченного строительства и всемирными нормами проектирования и строительства, такими как LEED (международный) и BREEAM (Великобритания).

Il marchio GREENGUARD certifica i prodotti che negli ambienti interni garantiscono i più elevati standard di qualità dell'aria.

Tutte le collezioni LOVE TILES in gres porcellanato, monoporosa e gres laminato hanno ottenuto la certificazione GREENGUARD GOLD, cioè lo standard di UL con i limiti più stringenti di emissioni di VOC, e sono perciò in grado di assicurare la migliore salubrità alle persone che vivono e che abitano gli ambienti. Per questo possono essere impiegate in ambienti come scuole e strutture sanitarie, frequentate da soggetti sensibili come i bambini e gli anziani.

GREENGUARD GOLD è una certificazione ampiamente riconosciuta e richiesta dai programmi di edilizia sostenibile e dai regolamenti di progettazione e costruzione in tutto il mondo, come il LEED (internazionale) e il BREEAM (UK).

Certificação

Certification | Certification | Zertifizierung | Сертификация | Certificazione

TECNOLOGIA DE VANGUARDA

Cada matéria prima natural utilizada, cada processo produtivo e cada tecnologia da complexa actividade da unidade industrial da Love Tiles, são estudadas de forma a minimizar o impacto ambiental, poupando e reciclando, com a vontade de transformar desperdícios em recursos e otimizar a utilização da energia produzida. A Love Tiles está na vanguarda na adoção de medidas ecologicamente sustentáveis as quais são demonstradas pelos mais minuciosos controlos quotidianamente efectuados.

CUTTING-EDGE TECHNOLOGY

Each raw material used, each productive process and each technology of the complex activity of the Love Tiles sites are studied in order to reduce the environmental impact, by saving, recycling, filtering, with the will of transforming the waste in resources and optimize the use of energy. Love Tiles is on the cutting-edge of adopting ecologically sustainable practices and this is demonstrated by the most accurate controls, repeated on a daily basis.

TECNOLOGIE D'AVANT-GARDE

Chaque matière première, chaque processus productif et chaque technologie de la complexe activité des établissements de Panariagroup sont étudiés de façon à limiter l'impact environnemental en épargnant, recyclant et filtrant avec la volonté de transformer les déchets en ressources et optimiser l'usage de l'énergie produite. Gres Panaria Portugal est à l'avant-garde dans l'action et les pratiques pour l'environnement comme le démontrent les contrôles les plus exigeants répétés au quotidien.

SPITZENTECNOLOGIE

Love Tiles hat die verwendeten Rohstoffe, Produktionsverfahren und Techniken in der komplexen Unternehmensaktivität im Bereich der industriellen Produktion des Unternehmens im Hinblick auf die Umweltauswirkungen eingehendst analysiert. Materialeinsparungen und Recycling stehen auf der Tagesordnung. Aus Abfällen werden Ressourcen. Die Nutzung freigesetzter Energie ist optimiert. Love Tiles ist führend, was die Verwendung von ökologisch nachhaltigen Maßnahmen betrifft. Täglich minutios durchgeführte Kontrollen sind der Beweis dafür.

НОВЕЙШИЕ ТЕХНОЛОГИИ

Используемое сырьё, каждый производственный процесс и каждая технологическая цепочка комплексной деятельности Love Tiles изучаются с целью уменьшения воздействия на окружающую среду за счет энергосбережения, переработки, фильтрации, с намерением превратить отходы в ресурсы и оптимизировать использование энергии. Love Tiles находится в авангарде внедрения eco-friendly методов, о чем свидетельствуют самые тщательные ежедневные проверки.

TECNOLOGIA ALL'VANGUARDIA

Ciascuna delle materie prime naturali utilizzate, ogni processo produttivo e ogni tecnologia della complessa attività dell'unità industriale di Love Tiles, sono studiati per ridurre al minimo l'impatto ambientale, risparmiando e riciclando, con la volontà di trasformare i rifiuti in risorse e ottimizzare l'utilizzo dell'energia prodotta. Love Tiles è all'avanguardia nell'adozione di misure ecologicamente sostenibili, dimostrate dai più rigorosi controlli quotidiani effettuati.

A CERTIFICAÇÃO AMBIENTAL

A unidade industrial da Love Tiles obteve certificações ambientais internacionais de grande prestígio. Entidades e organismos de controlo reconheceram oficialmente o trabalho feito pela empresa para a salvaguarda dos recursos naturais do planeta. Esta certificação testemunha as boas práticas ambientais da Love Tiles, na salvaguarda do desenvolvimento sustentável. Esta é uma demonstração concreta de como é possível conciliar Qualidade, Inovação Industrial e Design com uma séria política de salvaguarda do ambiente.

THE ENVIRONMENT CERTIFICATION

Love Tiles have obtained the most prestigious International environmental certifications. Agencies and control bodies have officially recognized the work done by the company for the safeguarding of the earth's natural resources. These certifications are proof of the high standards attained by Love Tiles, a company which is a forerunner in terms of sustainable development. These are a clear proof of how it is possible to reconcile quality, industrial innovation and design with a serious policy for environmental safeguard.

LA CERTIFICATION ENVIRONNEMENTALE

Love Tiles a obtenu de prestigieuses certifications environnementales internationales. Les entités et les organismes de contrôle ont officiellement reconnu le travail fourni par l'entreprise pour la préservation des ressources naturelles de la planète. Cette certification témoigne des bonnes pratiques environnementales de Gres Panaria Portugal, pour la protection du développement durable. C'est une démonstration concrète de l'engagement de l'entreprise en termes de Qualité, d'Innovation et de Design, le tout alié à une sérieuse politique de protection de l'environnement.

UMWELTZERTIFIZIERUNG









ie Produktionseinheit der Love Tiles wurde weltweit mit Umweltzertifizierungen von großem Prestige ausgezeichnet. Körperschaften und Kontrolleinrichtungen erkannten offiziell das Unternehmen für seine Arbeit zum Erhalt der Naturressourcen auf der Erde an. Die Zertifizierungen bezeugen die guten Umweltpolitiken der Love Tiles für die Wahrung der nachhaltigen Entwicklung. Dies ist ein konkreter Beweis dafür, dass es möglich ist, Qualität, industrielle Innovation und Design mit einer ernsthaften Politik der Umwelterhaltung zu vereinbaren.

ЭКОЛОГИЧЕСКАЯ СЕРТИФИКАЦИЯ

Производственное предприятие Love Tiles получило престижные международные экологические сертификаты. Юридические лица и контролирующие органы официально признали работу, проделанную компанией по охране природных ресурсов планеты. Данная сертификация свидетельствует о хороших методах защиты окружающей среды Love Tiles для обеспечения устойчивого развития. Это конкретная демонстрация того, как можно совместить качество, промышленные инновации и дизайн с серьезной политикой защиты окружающей среды.

A CERTIFICAZIONE AMBIENTALE

L'unità industriale di Love Tiles ha ottenuto prestigiose certificazioni ambientali internazionali. Enti e organismi di controllo hanno ufficialmente riconosciuto il lavoro svolto dalla società per la salvaguardia delle risorse naturali del pianeta. Questa certificazione attesta le buone pratiche ambientali di Love Tiles, nella tutela dello sviluppo sostenibile. Si tratta di una concreta dimostrazione di come sia possibile conciliare Qualità, Innovazione Industriale e Design con una seria politica di tutela dell'ambiente.

	Reutilização de caco cru Recycling non fired material Réutilisation du tesson Wiederverwendung unbearbeiteter Scherben Переработка необожженного сырья Riutilizzo degli scarti crudi
	Reciclagem de caco cozido Fired material, used for construction Recyclage du tesson cuit Recycling von erhitzen Scherben Переработка обожженного сырья Riutilizzo/riciclo degli scarti cotti
	Water, every drop counts 100 % reciclagem de água do processo Recyclage des eaux du processus productif 100 % - es Recycling von in Verfahren benutztes Wasser 100% повторное использование технологической воды Riutilizzo del 100% delle acque di processo
	Reducing emission Baixas emissões gasosas para a atmosfera Faibles émissions de gaz dans l'atmosphère Geringe Abgabe gashaltiger Emissionen in die Atmosphäre Низкие выбросы газов в атмосферу Minime emissioni in atmosfera
	Energy saving Poupança de energia Économie d'énergie Energieeinsparung Энергосбережение Risparmio energetico
	From packaging to recycling 100% de materiais recicláveis utilizados na embalagem 100% de matériaux recyclables utilisés dans l'emballage 100% Recycling-Material wird für Verpackungen benutzt 100% перерабатываемые материалы, используемые в упаковке Utilizzo di imballaggi 100% riciclabili
	Sustentabilidade dos produtos cerâmicos Sustainability of ceramic products Durabilité des produits céramiques Nachhaltigkeit von Keramikprodukten Экологичность керамических изделий Sostenibilità dei prodotti ceramici
	FAO pallets paletes FAO PAO pallettes FAO Palletten Паллеты FAO Pallet FAO

Certificação

Certification | Certification | Zertifizierung | Сертификация | Certificazione

	ISO 14001 Para estabelecimentos de baixo impacto ambiental e alta eficiência. For production sites with low impact and high efficiency. Produit fabriqué sans négliger l'environnement Produkt herstellung unter Einbeziehung der Umwelt Для производственных площадок с низким воздействием на окружающую среду и высокой эффективностью Per stabilimenti produttivi ad alta efficienza e basso impatto ambientale.
	EMAS Para ser verde e transparente Being green and transparent Pour être vert et transparent Grün und transparent Быть зелёным и прозрачным Per essere verde e trasparente
	LEED Uma marca para o ambiente A brand for the environment Une marque pour l'environnement Eine Marke für die Umwelt Бренд для окружающей среды Un marchio per l'ambiente
	GREEN BUILDING COUNCIL ITALY Para uma nova cultura de construção For a new culture in construction Pour une nouvelle culture de construction Für einer neues aufbaukultur К новой культуре строительства Per una nuova cultura edilizia

Index ▼

Colour Map ▼

Collections ▼

Technical Specifications ▼

Calibers

Certification

General Sales Conditions

Laying Suggestions

Outdoor extra thick

Package

Pr(ect

Symbols

Technical Information

Certificação

Certification | Certification | Zertifizierung | Сертификация | Certificazione

APCER



EMAS



IQNET



Certificação

Certification | Certification | Zertifizierung | Сертификация | Certificazione



CERTIF

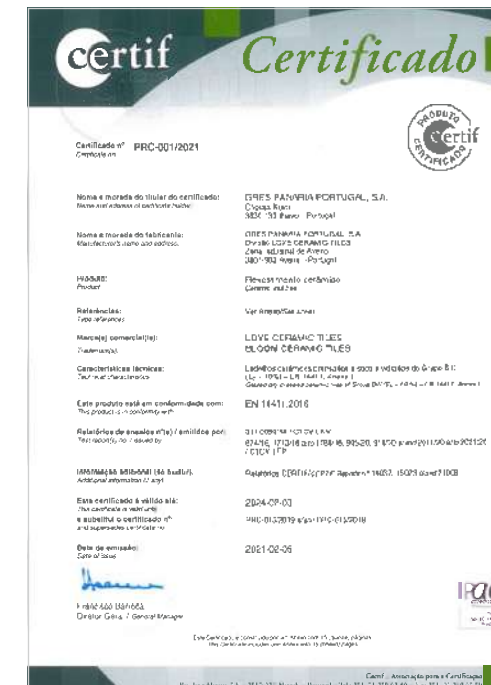

Para mais informações contactar Love Tiles.
If necessary, for further queries, please contact Love Tiles.
Pour des renseignements complémentaires, prière de contacter Love Tiles.
Für weitere Erklärungen, kontaktieren Sie bitte Love Tiles.
Более детальную информацию Вы можете получить связавшись с Love Tiles.
Per ulteriori informazioni contattare Love Tiles.



A qualidade do Grés Porcelânico vitrificado da Love Tiles encontra-se certificada pelas principais instituições da especialidade, nomeadamente pelo Centre Scientifique et Technique du Bâtiment França, usufruindo deste o prestígio de produto de marca QB-UPEC.

Para mais informações por favor consulte <https://evaluation.cstb.fr>

The quality of the Love Tiles vitrified porcelain ceramic tile has been certified by the main institutions in the field, namely the Centre Scientifique et Technique du Bâtiment in France, benefiting from the prestige of the QB-UPEC brand mark.

For further information please consult <https://evaluation.cstb.fr>

La qualité du grés cérame vitrifié de Love Tiles a obtenu le certificat des principales institutions de la spécialité notamment du Centre Scientifique et Technique du Bâtiment en France, jouissant du prestige de produit de marque QB-UPEC.

Pour plus d'informations consulter <https://evaluation.cstb.fr>

Die Qualität des glasierten Feinsteinzeugs von Love Tiles ist von den wichtigsten Institutionen dieses Fachbereichs zertifiziert, namentlich das Centre Scientifique et Technique du Bâtiment in Frankreich, das ihm die Klassifizierung QB-UPEC verlieh.

Weitere Informationen finden Sie unter: <https://evaluation.cstb.fr>

Качество глазурованного керамогранита Love Tiles сертифицировано ведущими специализированными агентствами, в частности французским Центром Науки и Техники «Technique du Bâtiment». Классификация продукции отвечает стандартам качества QB-UPEC.

Для получения дополнительной информации заходите на <https://evaluation.cstb.fr>

La qualità del Gres porcellanato smaltato della Love Tiles è certificato dalle principali istituzioni specializzate, cioè, per il Centre Scientifique et Technique du Bâtiment in Francia, sfruttando del prestigio del prodotto marchiato QB-UPEC.

Per ulteriori informazioni consultare <https://evaluation.cstb.fr>

Index ▾

Colour Map ▾

Collections ▾

Technical Specifications

Calibers

Certification

General Sales Conditions

Laying Suggestions

Outdoor extra thick

Package

Pr(ect

Symbols

Technical Information

UTILIZAÇÕES PREVISTAS | INTENDED USES | DOMAINES D'EMPLOI | VERWENDUNGSZWECKE | ПРЕДПОЛАГАЕМОЕ ИСПОЛЬЗОВАНИЕ | USI PREVISTI

As características técnicas bem como a facilidade de instalação, com ou sem colas (instalação a seco em relva, gravilha ou pavimentos sobreelevados), fazem das placas cerâmicas Love Tiles 20MM a melhor solução para a pavimentação de espaços exteriores sejam eles públicos ou privados, tais como jardins, garagens, caminhos pedonais, terraços, piscinas, áreas urbanas, etc.

Trata-se igualmente de uma boa solução para combinar espaços interiores e exteriores.

The characteristics of the product and the ease of installation, both with or without adhesive (dry installation on grass, gravel, or elevated floors), make the 20MM thick porcelain tile by Love Tiles the best solution for external flooring of public and residential areas, such as urban spaces, pavements, garden paths, car parks, terraces, swimming pool edges, bathing facilities, parks and much more.

The best solution to match external and internal spaces.

Les caractéristiques du produit ainsi que l'extrême facilité de pose aussi bien à sec (sur herbe, gravier, sols surélevés) qu'avec adhésif, font du grès cérame Love Tiles épaisseur 20MM, la meilleure solution pour les pavages externes de zones publiques et résidentielles: places urbaines, trottoirs, voies piétonnes, parkings, terrasses, bords de piscine, établissements balnéaires, aménagement public paysager et bien d'autres domaines encore.

Une solution optimale pour obtenir un ensemble parfaitement coordonné entre intérieur et extérieur.

Die Produkteigenschaften und extreme Einfachheit sowohl der Trockenverlegung (auf Gras, Kies, als Doppelboden) als auch der Klebverlegung, machen das Feinsteinzeug von Love Tiles mit 20MM Stärke zur besten Lösung bei Bodenbelägen im Außenbereich von öffentlichen und privaten Anlagen: Stadtplätze, Bürgersteige, Wege, Parkplätze, Terrassen, Poolumrandungen, Badeanlagen, öffentliche Grünanlagen und vieles mehr.

Die beste Lösung um eine optimale Koordination zwischen Innen- und Außenbereich zu erhalten.

Технические характеристики и простота укладки, с или без использования клея (сухая укладка поверх травы, поверх гравия или фальшпола), делают керамогранит 20 мм от Love Tiles отличным решением для мощения различных пространств, садов, гаражей, пешеходных дорожек, террас, плавательных бассейнов, городских районов и т.д.

Также является хорошим решением для комбинирования пространств внутренних и наружных.

Le caratteristiche tecniche e la facilità di posa, sia a secco (su erba, ghiaia, in pavimenti sopraelevati) che a colla, rendono le piastrelle in ceramica 20MM Love Tiles la migliore soluzione per la pavimentazione di spazi esterni, siano essi pubblici o privati, come giardini, garage, passaggi pedonali, terrazze, piscine, aree urbane, ecc.

È anche una buona soluzione per ottenere un ottimo coordinabilità tra interno ed esterno.

APLICAÇÃO SOBREELEVADA | ELEVATED FLOOR INSTALLATION | POSE SURÉLEVÉE | VERLEGUNG ALS DOPPELBODEN | УСТАНОВКА ФАЛЬШПОЛОВ | POSA SOPRAELEVATA

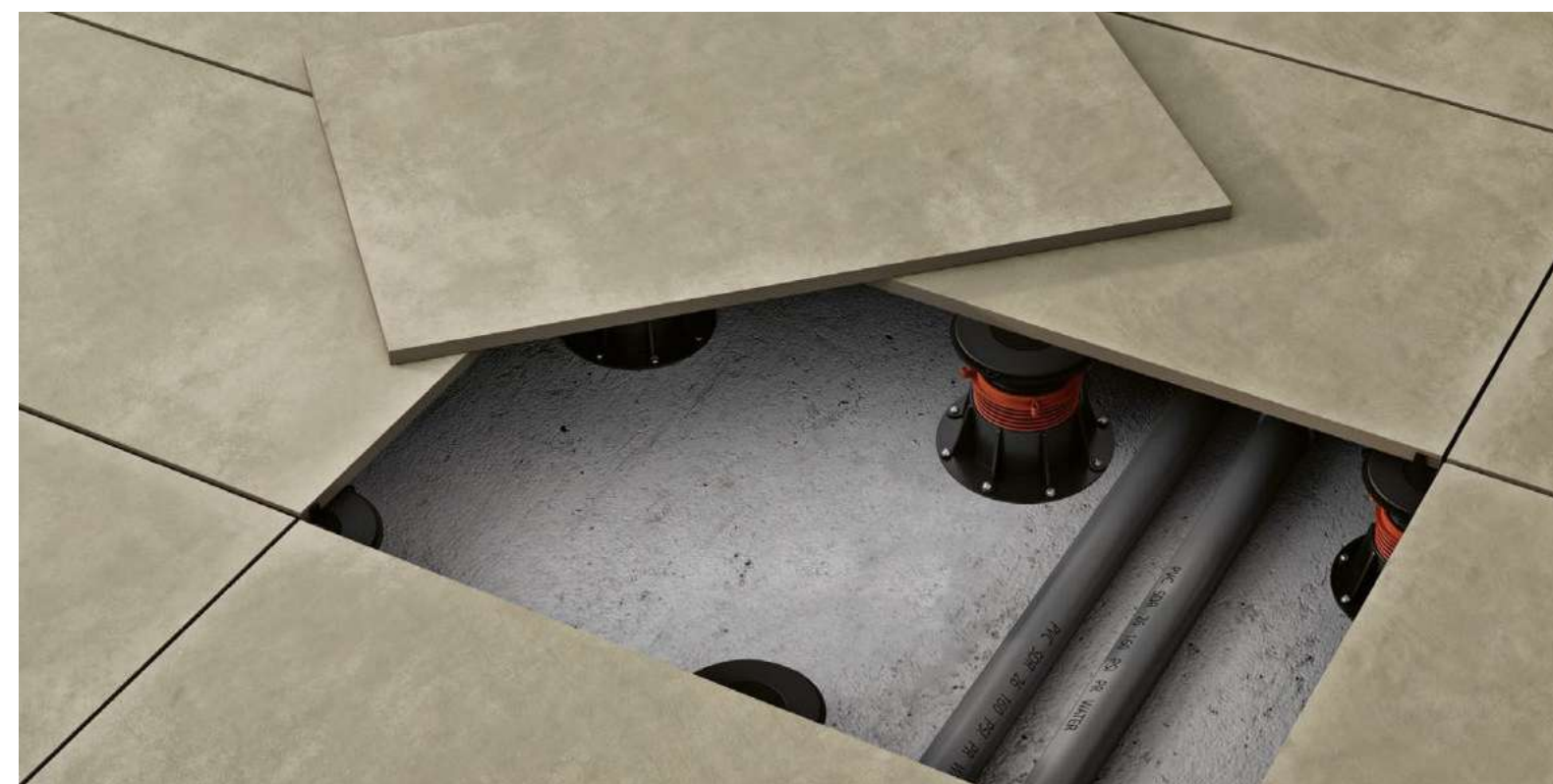

Technical Specifications

Calibers

Certification

General Sales Conditions

Laying Suggestions

Outdoor extra thick

Package

Pr(ect

Symbols

Technical Information

	Jardins e espaços públicos Gardens and public areas Jardins et espaces publics Gärten und öffentliche Anlagen Сады и общественные зоны Giardini e spazi pubblici
	Terraços Terraces Terrasses Terrassen Террасы Terrazze
	Complexos e estâncias balneares Seaside resorts Complexes balnéaires Badekomplexe und Seebäder Морские курорты Complessi e stabilimenti balneari
	Áreas urbanas Urban areas Zones urbaines Städtische Gebiete Городские районы Aree urbane

	Parques de estacionamento Parking lots Parkings Parkplätze Автомобильные стоянки Parcheggi auto
	Calçadas, acessos e zonas pedonais Sidewalks and pedestrian areas Zones piétonnes Bürgersteige, Zugänge und andere Fußgängerzonen Трогуары и пешеходные зоны Marciapiedi, ingressi e zone pedonali
	Envolventes de piscina Pool surrounding areas Contours de piscines Bereiche in der Umgebung von Schwimmbecken Зоны вокруг бассейна Bordi di piscine
	Zonas industriais Industrial areas Zones industrielles Industriegebiete Промышленные зоны Zone industriali

Instruções de combinação de tamanhos e suportes na aplicação sobreelevada
Instructions for matching sizes and pedestals in elevated floor installation
Instruction pour le couplage des formats et supports lors de la pose surélevée
Anweisungen für die Verbindung von Formaten und Auflagen bei der Verlegung von Doppelböden
Инструкции для комбинирования размеров и опор для навесных полов
Istruzioni per l'abbinamento di formati e supporti nella posa sopraelevata

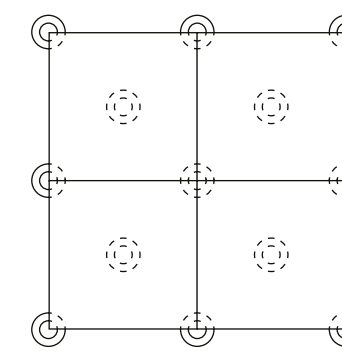

60x60

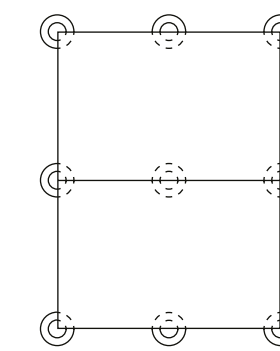

60x90

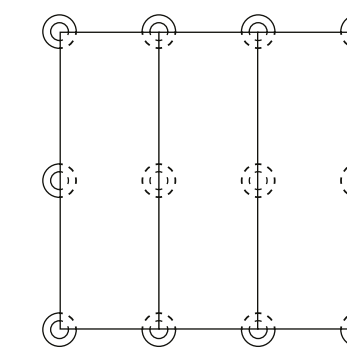

40x120

PEÇAS ESPECIAIS | SPECIAL PIECES | PIÈCES SPÉCIALES | SPEZIALTEILE | СПЕЦИАЛЬНЫЕ ИЗДЕЛИЯ | PEZZI SPECIALI - 20MM

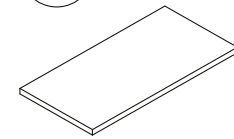

Base
Straight edge
Margelle
Stufenplatte
Ступень базовая
Gradino costa retta

30x60 20mm AS
30x60 Ret. 20mm AS

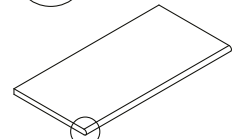

Base boleada
Bullnose
Margelle arrondie
Stufenplatte abgerundet
Ступень с закругленной фаской
Gradino costa toro

30x60 20mm AS
30x60 Ret. 20mm AS

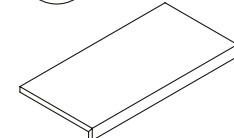

Degrau Espessurado 20mm
Step extra thick 20mm
Nez de marche forte épaisseur 20mm
Massive stufenplatte 20mm
Ступень утолщенная 20mm
Gradino spessorato 20mm

30x60 Ret. 20mm AS
30x90 Ret. 20mm AS **
30x120 Ret. 20mm AS ***

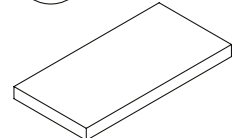

* Degrau Espessurado 20mm Canto
Step extra thick 20mm corner
Nez de marche forte épaisseur 20mm angle
Ecke massive stufenplatte 20mm
Угловая ступень утолщенная 20mm
Angolo gradino spessorato 20mm

30x60 Ret. 20mm AS
30x90 Ret. 20mm AS **
30x120 Ret. 20mm AS ***

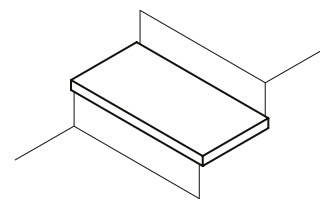
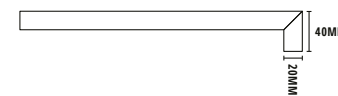

Canto direito
Right corner
Angle droit
Rechten ecke
Правый Угол
Angolo Destro

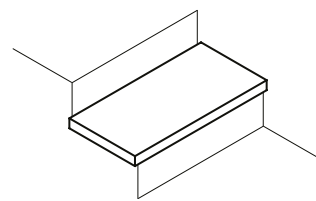

Canto esquerdo
Left corner
Angle gauche
Links ecke
Левый Угол
Angolo Sinistro

*Disponível no canto direito e esquerdo
Available in right and left corner
Disponível dans les coin droit et gauche
Erhältlich in der rechten Ecke und links
Доступна как правая так и левая угловая ступень
Disponibile nell'angolo destro e sinistro

**Available only on Avenue, Canyon, Ground and Mémorable collections
Disponible uniquement dans les collections Avenue, Canyon, Ground et Mémorable
Verfügbar nur in Serie Avenue, Canyon, Ground und Mémorable
Disponível apenas nas coleções Avenue, Canyon, Ground e Mémorable
Доступно только в коллекциях Avenue, Canyon, Ground и Mémorable
Disponibile solamente per le serie Avenue, Canyon, Ground e Mémorable

*** Available only on Native and Wooden collections
Disponible uniquement dans les collections Native et Wooden
Verfügbar nur in Serie Native und Wooden
Disponível apenas nas coleções Native e Wooden
Доступно только в коллекциях Native и Wooden
Disponibile solamente per le serie Native e Wooden

PEÇAS ESPECIAIS | SPECIAL PIECES | PIÈCES SPÉCIALES | SPEZIALTEILE | СПЕЦИАЛЬНЫЕ ИЗДЕЛИЯ | PEZZI SPECIALI - 20MM

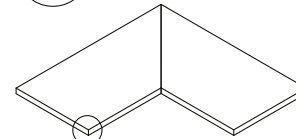

* Canto interior
Straight edge inner corner
Margelle angle bord droit intérieur
Eckstufe
Внутренний угол
Angolo interno

30x60 20mm AS
30x60 Ret. 20mm AS

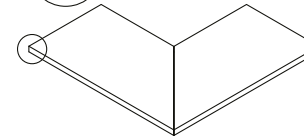

* Canto exterior
Straight edge outer corner
Margelle angle bord droit extérieur
Eckstufe Außenseite
Внешний угол
Angolo esterno

30x60 20mm AS
30x60 Ret. 20mm AS

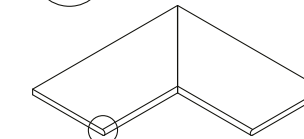

* Canto interior boleado
Bullnose inner corner
Margelle bord intérieur arrondi
Abgerundete Innenecke (Gärung)
Внутренний угол с фаской
Gradino con bordo interno a toro

30x60 20mm AS
30x60 Ret. 20mm AS

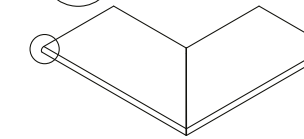

* Canto exterior boleado
Bullnose outer corner
Margelle bord extérieur arrondi
Abgerundete Aussenecke (Gärung)
Внешний угол с фаской
Gradino con bordo esterno a toro

30x60 20mm AS
30x60 Ret. 20mm AS

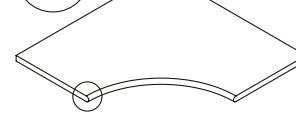

** Canto interior redondo boleado
Internal corner bullnose
Margelle angle rentrant arrondi
Abgerundete Innenecke
Угол внутренний округлый с фаской
Gradino ad angolo rientrante con toro

60x60 20mm AS
60x60 Ret. 20mm AS

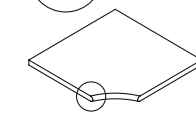

*** Canto interior redondo boleado
External corner bullnose
Margelle angle rentrant arrondi
Abgerundete Innenecke
Угол внутренний округлый с фаской
Gradino ad angolo rientrante con toro

40x40 Ret. 20mm AS

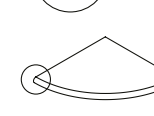

** Canto exterior redondo boleado
External corner bullnose
Margelle angle sortant arrondi
Abgerundete Aussenecke
Угол внешний округлый с фаской
Gradino ad angolo sporgente con toro

30x30 20mm AS
30x30 Ret. 20mm AS

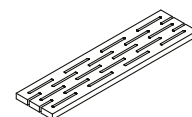

Grelha LT
Overflow grille LT
Grille LT
Überlauf LT
Решетка LT
Griglia LT

15x60 20mm AS
15x60 Ret. 20mm AS

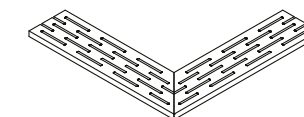

* Canto grelha LT
Overflow corner grille LT
Angle grille LT
Überlauf Ecke LT
Углы решетки LT
Griglia ad angolo LT

15x60 20mm AS
15x60 Ret. 20mm AS

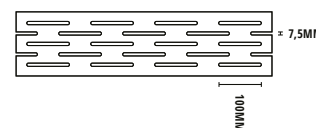

** Vendido ao par - Sold per two pieces set - Vendu à la paire
** Paarweise verkauft - Продается в комплекте состоящим из двух штук - Venduta a coppie

** Raio - Radius - Rayon - Radius - Radius - Радиус: 30cm
*** Raio - Radius - Rayon - Radius - Radius - Радиус: 10cm

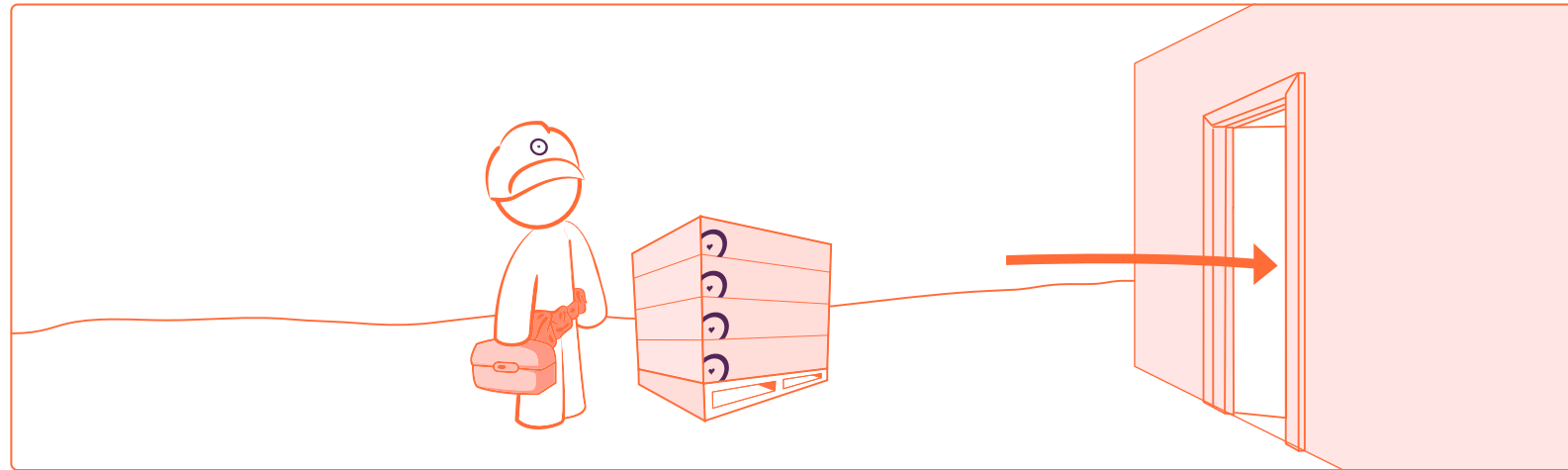

Antes de iniciar o assentamento do material cerâmico, deverá ter em consideração os seguintes aspetos:

- Verificar se o material cerâmico é indicado para utilizar no local selecionado de acordo com as suas especificações e características técnicas;
- Verificar se existe material suficiente para realizar a obra;
- Confirmar nas caixas se o produto é da mesma tonalidade, escolha e calibre.

O bom desempenho do material cerâmico depende fortemente das condições de aplicação pelo que é de extrema importância garantir os seguintes pressupostos:

Before (beginning the) laying (of) ceramic material, you should take the following aspects into account:

- Check if the ceramic material is suitable for (use at) the selected site, according to its specifications and technical characteristics;
- Check whether there is enough material to conclude the work;
- Check the boxes to see/confirm in the boxes if the product is in the same shade, choice and caliber.

The good performance of the ceramic material depends strongly on the conditions of application for which it is extremely important to ensure the following assumptions:

Avant de commencer la pose du matériau céramique, les aspects suivants devront être pris en considération:

- Vérifier si le matériau céramique est indiqué pour une utilisation dans le lieu choisi, conformément à ses spécifications et caractéristiques techniques;
- Vérifier s'il existe la quantité de matériau suffisante pour réaliser le chantier;
- Confirmer dans les boîtes si le produit est du même ton, de la même qualité, et du même calibre.

La bonne performance du matériau céramique dépend fortement des conditions d'application. Il est donc extrêmement important de garantir les conditions préalables suivantes:

Vor dem Beginn der Verlegearbeiten sollten Sie folgende Punkte berücksichtigen:

- Bitte überprüfen Sie, ob die gewählte Fliese laut ihrer Oberflächenbeschaffenheit und ihren technischen Eigenschaften geeignet für das Einsatzgebiet ist;
- Bitte prüfen Sie nach, ob die Menge der gewählten Fliese ausreicht, um das geplante Bauprojekt fertig zu stellen;
- Bitte prüfen Sie, ob die Fliesen aus verschiedenen Kartons dieselbe Beschaffenheit, (Ton, Wahl und Kaliber) haben.

- Die Leistungsfähigkeit der Fliese hängt stark davon ab, wie die Fliesen verlegt werden. Daher ist es sehr wichtig, die folgenden Punkte zu beachten:

Перед началом работ по укладке керамического материала необходимо учесть следующие моменты:

- Проверить, подходит ли керамический материал для использования в назначенном месте согласно его свойствам и техническим характеристикам;
- Проверить, имеется ли материал в количестве, достаточном для производства работ;
- Проверить по упаковкам, является ли продукция того же оттенка, ассортимента и размера.

Хорошие эксплуатационные показатели использования керамического материала сильно зависят от условий кладки, поэтому исключительно важно обеспечить следующие предпосылки:

Prima di iniziare la posa del materiale ceramico, occorre tener conto dei seguenti aspetti:

- Controllare che il materiale ceramico sia idoneo per l'uso nella posizione selezionata secondo le sue specifiche e caratteristiche tecniche;
- Verificare se c'è abbastanza materiale per eseguire il lavoro;
- Confermare sulle scatole se il prodotto è della stessa tonalità, selezione e calibre.

Le buone prestazioni del materiale ceramico dipendono in gran parte dalle condizioni di posa ed è quindi estremamente importante garantire i seguenti presupposti:

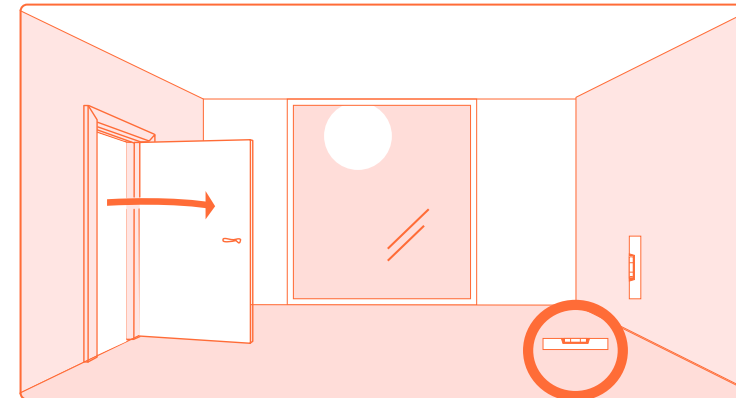

01

O SUPORTE

O suporte deve apresentar-se estável, limpo de resíduos, fendas e poeiras. Deverão ser respeitados os tempos de cura e estabilidade dos tratamentos a que possa ter sido sujeito. Deve fazer-se a verificação da planaridade do mesmo, procedendo à regularização, se necessário com a ajuda de produtos adequados a esse fim. Estes aspetos são vitais para pavimentos e revestimentos cerâmicos.

SUPPORT

The support must be stable, free of debris, dust and cracks. Curing times and stability of the treatments to which the support may have been subjected should be respected. You should check its flatness and stabilize it, if necessary with the help of products suitable for the purpose. These aspects are vital for wall and floor ceramic tiles.

LE SUPPORT

Le support doit être stable, exempt de résidus, fentes et poussières. Les temps de durcissement et de stabilité des traitements auxquels il doit être soumis devront être respectés. La planéité du support doit être vérifiée et le nivellement doit être réalisé si cela est nécessaire, à l'aide de produits appropriés. Ces aspects sont essentiels pour les revêtements de sol et muraux céramiques.

DER UNTERGRUND

Der Untergrund muss stabil, sauber, sowie frei von Rissen und Staub sein. Sollte der Untergrund vor dem Verlegen der Fliesen speziell behandelt werden müssen, so sollten Sie darauf achten, dass die Behandlung gut gelungen und abgeschlossen ist, bevor Sie die Fliesen verlegen. Sie sollten den Untergrund inspizieren. Falls er nicht eben ist, muss er mit Hilfe von passenden Produkten grundiert werden. Diese Vorsicht ist angebracht und eine unabdingbare Voraussetzung für das fachgerechte Verlegen von Boden- und Wandfliesen.

ОПОРНАЯ ОСНОВА

Опорная основа должна быть устойчивой, очищенной от отходов, трещин и пыли. Должны соблюдаться сроки полного высыхания и устойчивости процессов обработки, которым она может быть подвержена покрытия. Следует произвести проверку на плоскостность и, если нужно, отрегулировать ее с использованием предназначенных для этого материалы. Эти аспекты являются жизненно важными при установке керамических напольных покрытий и облицовке.

SUPPORTO

Il supporto deve essere stabile, privo di sporcizia, polvere e crepe. Le tempistiche di presa e di stabilità dei trattamenti a cui potrebbe essere stato sottoposto devono essere rispettate. Occorre controllare la sua planarità, livellandolo, se necessario, con l'aiuto di prodotti idonei a tale scopo. Questi aspetti sono fondamentali per pavimenti e rivestimenti in ceramica.

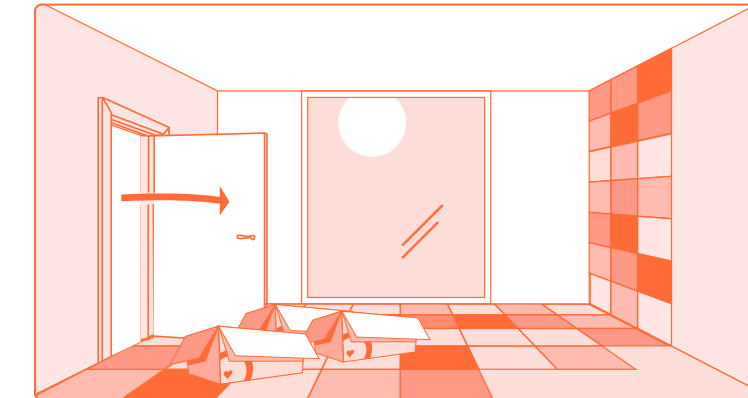

02

O MATERIAL

Para obter um melhor efeito visual do produto, aconselha-se a utilização, alternada, de peças cerâmicas retiradas de várias embalagens em simultâneo. Caso o produto seja desestabilizado ou tenha gráfica e tonalidade diferente, deverá ser aplicado de forma aleatória.

MATERIAL

For a better visual effect of the product, it is advisable to use alternating ceramic pieces taken from various packages simultaneously. If the product has shade variations or has different graphics and shades, it should be applied randomly.

LE MATÉRIAU

Pour obtenir un meilleur effet visuel avec le produit, il est conseillé d'utiliser de forme alternée des pièces céramiques retirées simultanément de plusieurs emballages. Si le produit est dénuancé ou a un aspect graphique différent et une tonalité différente, il devra être appliqué de forme aléatoire.

DAS MATERIAL

Damit Sie das beste Ergebnis erzielen, ist es ratsam, die Fliesen immer aus verschiedenen Paketen zu wählen und in regelmäßig abwechselnder Folge zu verlegen. Falls das Produkt diverse Farbschattierung, einen unterschiedliche Farbton oder grafisches Design aufweist, müssen die Fliesen auf diese Weise verlegt werden.

МАТЕРИАЛ

Для получения лучшего визуального эффекта советуем использовать попеременно керамические образцы, беря их из разных коробок одновременно. Если продукция без оттенков или с различающимися графическими изображениями и тональностью, установка должна осуществляться в произвольном порядке.

MATERIALE

Per ottenere un migliore effetto visivo del prodotto, si consiglia di utilizzare, in modo alternato, pezzi in ceramica prelevati contemporaneamente da diverse scatole. Se il prodotto è stonalizzato o ha una grafica e tonalità diversa, deve essere applicato in modo casuale.

Technical Specifications

Calibers

Certification

General Sales Conditions

Laying Suggestions

Outdoor extra thick

Package

Pr()tect

Symbols

Technical Information

Index

Colour Map

Collections

Informação Técnica

Technical Information | Information Technique | Technische Information | Техническая Информация | Informazione Tecnica

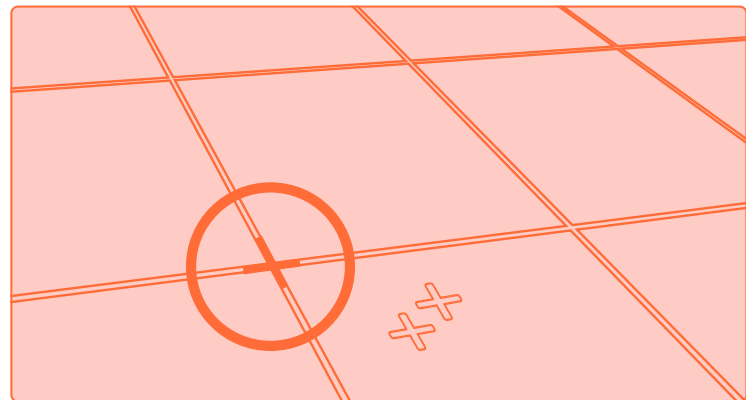

03



JUNTAS DE ASSENTAMENTO

Tendo em vista uma perfeita aplicação das peças cerâmicas, deve usar-se obrigatoriamente juntas de assentamento. Estas cumprem importantes funções estéticas e técnicas, facilitando o alinhamento dos materiais, absorvendo eventuais deformações que se possam fazer sentir na estrutura – chão e parede – e impedindo, assim, a transmissão destas deformações às peças cerâmicas.

Aconselhamos a utilização de niveladores aquando da aplicação de material de grandes formatos – 45x120, 35x100, 60x90 e 80x80.

Utilizar as juntas mínimas recomendadas de forma a garantir um bom aspeto estético das peças cerâmicas, bem como respeitar as normas de aplicação.

NOTA: independentemente dos valores aqui apresentados, o aplicador deverá sempre seguir as normativas dos países onde está a fazer este trabalho de aplicação.

JOINTS FOR TILE-LAYING

For a perfect application of the ceramic pieces, you should definitely use joints. They fulfill important aesthetic and technical functions, facilitating alignment of the materials, absorbing any possible deformation liable to be felt in the structure - floor and wall - thus preventing the transmission of deformations to the ceramic pieces.

We advise the use of leveling systems when applying big ceramic formats material – 45x120, 35x100, 60x90 and 80x80.

Use the minimum recommended joints so as to ensure a good aesthetic aspect of the ceramic pieces, and respect the rules of application as follows.

NOTE: Regardless of the values presented here, the person applying it should always follow the regulations of the countries where he is doing this application work.

JOINTS DE POSE

L'utilisation de joints de pose est obligatoire afin d'obtenir une pose parfaite des pièces céramiques., Ils remplissent une importante fonction esthétique et technique. Ils facilitent l'alignement des matériaux et absorbent d'éventuelles déformations qui peuvent se produire dans la structure – sols et murs – et empêchent donc la transmission de ces déformations aux pièces céramiques.

Nous recommandons l'utilisation de niveleurs lors de l'application de matériaux de grand format – 45x120, 35x100, 60x90 e 80x80.

Utiliser Les joints minimaux recommandés afin de garantir un bon aspect esthétique des pièces céramiques et respecter les normes d'application sont les suivants.

REMARQUE: Indépendamment des valeurs ici présentées, l'applicateur devra toujours suivre les réglementations du pays où il réalise ce travail d'application.

DAS VERFUGEN

Um die keramischen Platten perfekt zu verlegen, sollten Sie die Wand oder den Boden ordnungsgemäß verfugen. Die Fugen haben wichtige ästhetische und technische Funktionen. Sie erleichtern das Aufreihen der Fliesen; sie absorbieren eventuelle Verformungen der Wand oder des Bodens, und vermeiden dadurch die Übertragung dieser Verformungen auf die Fliesen.

Wir empfehlen die Benutzung von selbstnivellierenden Abstandhaltern, wenn es darum geht, Fliesen von grösseren Formaten zu verlegen, wie zum Beispiel (45x120, 35x100, 60x90, 80x80). Die empfohlenen Fugenbreiten, welche eine schöne Optik sowie eine regelgerechte Verlegung gewährleisten, sind nachfolgend angegeben.

WICHTIG: Abgesehen von den oben angegebenen Fugenbreiten, muss der Fliesenleger immer den jeweils geltenden landesspezifischen Vorschriften Folge leisten.

ПРОКЛАДКИ

Для получения безукоризненного результата при установке керамических деталей следует обязательно использовать прокладки. Они играют важную эстетическую и техническую роль, облегчая выравнивание материала, вбирая в себя возможную деформацию, которая может чувствоваться в структуре (пола и стены), препятствуя, таким образом, передаче этой деформации керамическим деталям.

Рекомендуем использовать системы выравнивания при укладке крупноформатной плитки - 45x120, 35x100, 60x90 и 80x80.

Использовать рекомендуемые минимальные прокладки, чтобы обеспечить отличный эстетический вид керамических деталей, а также соблюдать правила установки.

ПРИМЕЧАНИЕ: Независимо от приведённых здесь значений, специалист всегда должен соблюдать нормы той страны, в которой производит работы по укладке.

FUGHE

Per una perfetta posa delle piastrelle in ceramica, devono essere eseguite delle fughe. Queste svolgono importanti funzioni estetiche e tecniche, facilitando l'allineamento dei materiali, assorbendo eventuali deformazioni che potrebbero manifestarsi sulla struttura – pavimento e parete – e quindi prevenendo la trasmissione di queste deformazioni alle piastrelle in ceramica. Si consiglia l'uso di livellatori quando si applicano materiali di grande formato – 45x120, 35x100, 60x90 e 80x80.

Utilizzare le fughe minime raccomandate per garantire un buon aspetto estetico delle piastrelle in ceramica e rispettare le modalità di posa.

NOTA: indipendentemente dai valori sopra riportati, il posatore deve fare sempre riferimento alle specifiche normative vigenti nel paese in cui sta eseguendo questo lavoro di posa.

	aplicação application pose anwendung демонстрация posa		
acabamento finishing finition fertigung отделка finitura	interior indoor intérieur imen внутри помещения interno	exterior outdoor extérieur außen экстерьер externo	sobreelevado raised floor dalles sur plot doublebodem фальшпол piano rialzato
não retificado non rectified non rectifié presskante неректифицированный non rettificato	3mm	4mm *	–
retificado rectified rectifié rektifiziert ректифицированный rettificato	2mm	3mm *	–
20mm não retificado 20mm non rectified 20mm non rectifié 20mm presskante 20mm неректифицированный 20mm non rettificato	3mm	4mm *	3mm
20mm retificado 20mm rectified 20mm rectifié 20mm rektifiziert 20mm ректифицированный 20mm rettificato	2mm	3mm *	3mm

* para as cores escuras recomenda-se acrescentar 2mm à junta mínima. Consultar a ficha técnica do respetivo produto no site.

* it's recommended to increase in 2mm the minimum joint in the darker colours. For further information please go to our website and read product's technical data sheet.

* pour les couleurs foncées il est recommandé de rajouter 2mm au joint minimum. Consultez la fiche technique du produit respectif sur le site web.

* Bei dunklen Farben wird empfohlen, 2 mm zur Mindestfuge noch weiter hinzuzufügen. Konsultieren Sie das technische Datenblatt des Produkts auf der Website.

* для темных цветов рекомендуется добавить 2 мм к минимальному шву. Обратитесь к техническим данным соответствующего продукта на веб-сайте.

* Per i colori scuri si consiglia di aggiungere 2 mm al giunto minimo. Consultare la scheda tecnica del rispettivo prodotto sul sito web.

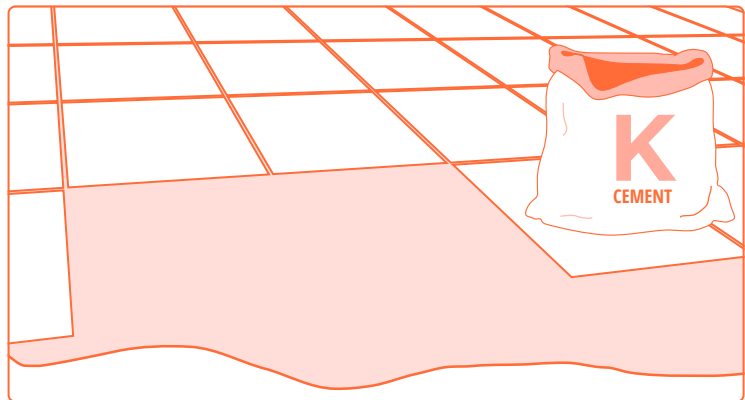

04

COLA E ARGAMASSAS

As argamassas, argamassas de rejuntamento, cimentos-colas e colas a utilizar deverão ter em conta o suporte e o fim a que se destinam as peças cerâmicas - interior, exterior, parede, pavimento - e a sua tipologia - monoporosa ou grés esmaltado.

Deverá seguir as instruções indicadas pelo fabricante sobre a sua utilização.

GLUE AND MORTAR

The mortars, grouting mortars, glue-cements, and glues to be used should take into account both the support and the intended purpose of the ceramic pieces - indoor, outdoor, wall, floor - and their typology – mono-porous / monoporosa or glazed stoneware.

You should follow the instructions provided by the manufacturer on its use.

COLLE ET MORTIERS

Les mortiers, mortiers de rejointoiement, ciments-colles et colles à utiliser devront tenir compte du support et de la fin à laquelle sont destinées les pièces céramiques - intérieur, extérieur, mur, plancher - ainsi que de leur typologie - monoporosa ou grés émaillé.

Vous devez suivre les instructions indiquées par le fabricant pour son utilisation.

KLEBER UND MÖRTEL

Welchen Mörtel, welchen Zementkleber oder welche andere Verbundmittel Sie am besten verwenden, hängt sowohl vom Untergrund als auch vom Material (Monoporosa, glasierte Fliesen) ab. Es kommt ebenso darauf an, ob die Fliesen im Außen- oder Innenbereich, an der Wand oder am Boden verlegt werden.

Bitte befolgen Sie die Herstellerangaben zum Gebrauch des Produktes.

КЛЕИ И РАСТВОРЫ

При выборе растворов, тампонажных растворов, цементных клеев и других видов клея необходимо учитывать основу и назначение керамических деталей – наружное, внутреннее, стены, напольное покрытие – и его типологию – монопористый или эмалированный керамогранит.

Необходимо соблюдать инструкции по их применению, разработанные производителем.

COLLE E MALTE

Le malte, malte fuganti, cementi-colla e colle da utilizzare devono tener conto del supporto e della destinazione delle piastrelle in ceramica – interno, esterno, parete, pavimento – e della loro tipologia – monoporosa o grés porcellanato smaltato.

Seguire le istruzioni per l'uso fornite dal fabbricante.

Informação Técnica

Technical Information | Information Technique | Technische Information | Техническая Информация | Informazione Tecnica

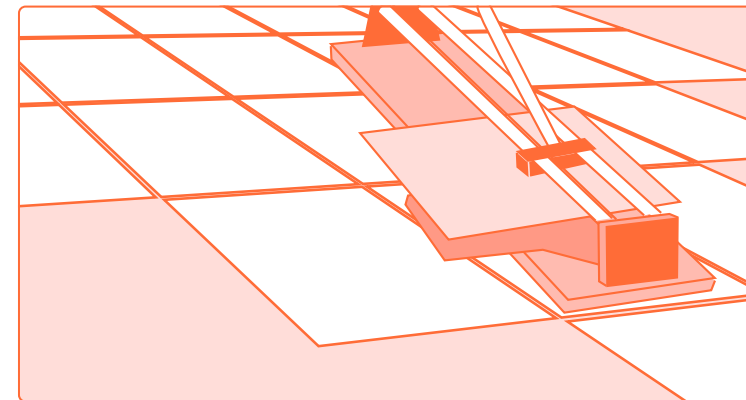

05

INSTRUÇÕES DE CORTE

Recomendamos o corte com arrefecimento de água ou utilização de cortador manual com método de marcação e corte durante o processo de instalação.

Não usar ferramentas elétricas com corte a seco durante o processo de instalação.

Técnicas de instalação impróprias poderão expor o instalador à poeira de sílica de forma prejudicial.

CUTTING INSTRUCTIONS

We recommend wet cutting or the score and snap method during the installation process.

Do not dry cut using power tools during the installation process.

Improper installation techniques could expose installer to harmful silica dust.

INSTRUCTIONS DE DÉCOUPE

Nous recommandons la découpe avec refroidissement d'eau ou usage d'un découpant manuel avec méthode de marçage et découpage pendant la pose.

Ne pas utiliser d'outils électriques ou de découpage à sec pendant la pose.

Des techniques de pose inadéquates pourront exposer le poseur à des poussières de silice et nuire à la santé.

SCHNEIDEEMPFEHLUNG

Wir empfehlen das Nassschneiden oder die Ritz- und Brechmethode während des Installationsprozesses.

Während des Installationsvorgangs nicht mit Elektrowerkzeugen trocken schneiden.

Durch unsachgemäße Installationstechniken kann der Installateur schädlichem Quarzstaub ausgesetzt werden.

ИНСТРУКЦИИ ПО РЕЗКЕ

Мы рекомендуем резку с водяным охлаждением или ручным плиткорезом с маркировкой и методом резки впроцессе установки.

Не используйте электроинструменты при сухой резке в процессе установки.

Неправильные методы укладки плитки зачастую сопровождаются выделением большого количества вредной кварцевой пыли, которое в свою очередь может отрицательно воздействовать на укладчика.

ISTRUZIONI PER IL TAGLIO

Si consiglia di utilizzare macchinari con raffreddamento ad acqua o utilizzare una taglierina manuale con un metodo di marcatura e taglio.

Non utilizzare utensili elettrici con taglio a secco.

Tecniche di installazione non corrette possono esporre l'installatore a polvere di silice dannosa per la salute.

Index

Colour Map

Collections

Technical Specifications

Calibers

Certification

General Sales Conditions

Laying Suggestions

Outdoor extra thick

Package

Pr(ect

Symbols

Technical Information

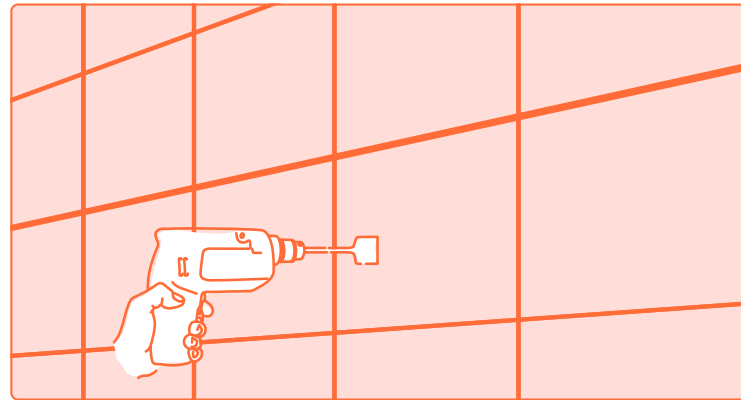

06

FUROS

Na furação deverão ser utilizadas brocas cranianas diamantadas com diâmetro adaptável ao furo pretendido.

HOLES

For drilling you should use diamond twist drills with a diameter adaptable to the desired hole.

PERÇAGES

Pour le perçage, utiliser des trépan diamantés avec un diamètre adapté au trou désiré.

LÖCHER

Löcher sollten im gewünschten Durchmesser mittels einer Diamanthammerbohrkrone in die Fliese gebohrt werden.

ОТВЕРСТИЯ

При сверлении отверстий необходимо использовать алмазные сверла диаметра, соответствующего предполагаемому отверстию.

FORI

Per realizzare fori circolari sulle piastrelle devono essere utilizzate delle frese a tazza diamantata con un diametro adattabile al foro stesso.



07

SEGURANÇA NA PREPARAÇÃO E ASSENTAMENTO DO MATERIAL

Aconselha-se a utilização de EPI (equipamento de proteção individual) adequado, nomeadamente, calçado de segurança, luvas de proteção e ainda óculos e proteção auditiva nas operações de corte do material.

Devem ser cumpridas as boas práticas a nível do levantamento e transporte manual de cargas.

SAFETY AND PREPARATION FOR LAYING THE MATERIAL

We advise the use of appropriate PPE (personal protective equipment), namely safety footwear, protective gloves and even goggles (safety glasses) and hearing protection in operations of cutting material.

Good practices must be followed in terms of lifting and carrying loads.

SÉCURITÉ LORS DE LA PRÉPARATION ET DE LA POSE DU MATÉRIAU

Il est conseillé d'utiliser un EPI (équipement de protection individuelle) approprié, notamment des chaussures de sécurité, des gants de protection, mais aussi des lunettes et une protection auditive lors des opérations de coupe du matériau.

Respectez les bonnes pratiques concernant le levage et le transport manuel de charges devront être appliquées.

SICHERHEITSHINWEISE FÜR DAS VERLEGEN VON FLIESEN

Wir empfehlen Ihnen, immer die passende Schutzkleidung zu tragen. Wir ermahnen Sie eindringlich, Schutzschuhe, -handschuhe, -brille sowie Gehörschutz zu benutzen, wenn Sie die Fliesen zuschneiden.

Achten Sie bitte auf die richtige Körperhaltung, wenn Sie Lasten heben und tragen.

ОХРАНА ТРУДА ПРИ ПОДГОТОВКЕ И УКЛАДКЕ МАТЕРИАЛА

Рекомендуется использование подходящих СИЗ (средств индивидуальной защиты), а именно, безопасной обуви, защитных перчаток, а также очков и средств звуковой защиты при резке материала.

Необходимо соблюдать правила безопасности при ручном подъеме и транспортировке грузов.

SICUREZZA NELLA PREPARAZIONE E POSA DEL MATERIALE

Si consiglia l'uso dei DPI (dispositivi di protezione individuale) idonei, quali scarpe antinfortunistiche, guanti di protezione e occhiali, nonché protezione dell'udito nelle operazioni di taglio del materiale.

Devono anche essere rispettate le buone pratiche a livello di sollevamento e movimentazione manuale dei carichi.

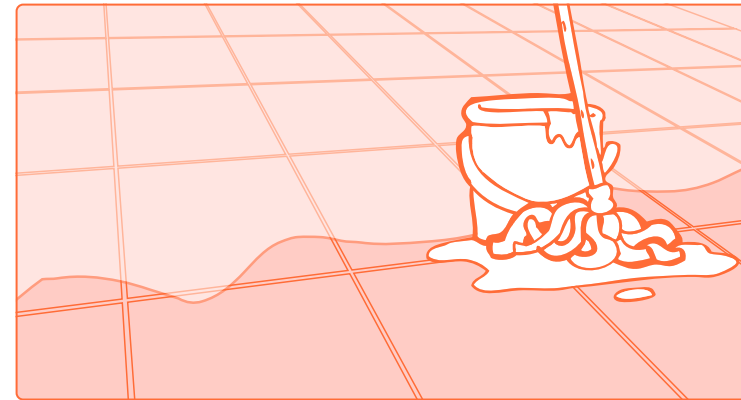

08

PROTEÇÃO E LIMPEZA

Imediatamente após o assentamento do material cerâmico recomenda-se que as peças cerâmicas sejam devidamente protegidas. Para remoção de sujidade pós-obra, tais como resto de junta, cimentos, etc, recomenda-se a utilização de um ácido desincrustante tamponado para remoção de todos os resíduos.

Na manutenção diária poderão ser utilizados detergentes comuns, respeitando as diluições recomendadas pelo respetivo fabricante.

Relativamente às peças decoradas, dever-se-á evitar a utilização de produtos de limpeza abrasivos, poderão danificar as peças.

As peças decoradas através da deposição de partículas de titânio - Genesis, acabamento gold, silver e copper - que lhe conferem um aspeto metálico deverão ser manuseadas com cuidado. A limpeza final e de manutenção deste tipo de produto deverá ser feita com detergentes próprios para metais - abrilhantador de aço inox - de forma a criar um efeito antiestático que possa repelir a sujidade e proteger o produto de gorduras e corrosão. A limpeza regular do produto deverá ser feita com um pano humedecido em água ou limpa-vidros, e após secagem deverá ser passado um pano seco.

PROTECTION AND CLEANING

All residues of glue and grout mortar should be cleaned from the surface of the parts immediately after application and in accordance with the manufacturer's instructions. Immediately after the laying of ceramic material it is recommended that the ceramic parts are / will be duly protected. For dirt removal after the work, such as left-over joints, cements, etc., it is recommended that you use a buffered descaling acid to remove all residues. In daily maintenance, ordinary detergents may be used, respecting the dilutions recommended by the respective manufacturer.

Regarding decorated pieces, you should avoid the use of abrasive cleansers that may damage the pieces. Pieces decorated through the depositing of titanium particles - Genesis: Gold, Silver, Copper - which give them a metallic aspect should be handled with care. The final cleaning and maintenance of this type of product should be made with detergents suitable for metals - stainless steel brightener - so as to create an antistatic effect that can repel dirt and protect the product from fats and corrosion. Regular cleaning of the product should be done with a damp cloth moisturized with water or window cleaner, and after it gets dry, a dry cloth shall be used.

PROTECTION ET NETTOYAGE

Tous les résidus de colle et de mortier de jointoiment doivent être nettoyés de la surface des pièces immédiatement après l'application et conformément aux instructions du fabricant. Immédiatement après la pose du matériau céramique, il est recommandé de protéger correctement les pièces céramiques. Pour l'élimination de la saleté résultant des travaux, comme les résidus de joints, ciments, etc., il est recommandé d'utiliser un acide tamponné désincrustant.

L'entretien quotidien pourra être réalisé avec des détergents ordinaires, en respectant les dilutions recommandées par le fabricant respectif.

Pour les pièces décorées, l'utilisation de produits de nettoyage abrasifs devra être évitée car ils pourront endommager les pièces.

Les pièces décorées grâce au dépôt de particules de titane - Genesis: Gold, Silver, Copper - qui lui confèrent un aspect métallique, devront être manipulées avec soin. Le nettoyage final et d'entretien de ce type de produit devra être réalisé avec des détergents spécifiques pour les métaux - agent de brillantage d'acier inox - afin de créer un effet antistatique qui puisse repousser la saleté et protéger le produit des graisses et de la corrosion. Le nettoyage régulier du produit doit être effectué avec un chiffon imbibé d'eau ou de nettoyant pour vitres et, après séchage, on doit passer un chiffon sec.

SCHUTZ UND REINIGUNG

Alle Rückstände von Klebstoff und Fugenmörtel sollten von der Oberfläche der Stücke unmittelbar nach dem Auftragen und in Übereinstimmung mit den Anweisungen des Herstellers gereinigt werden.

Bitte vergessen Sie nicht sofort nach Beendigung der Verlegearbeiten, die verflieste Fläche ordnungsgemäß zu schützen. Waschen Sie die verflieste Fläche mit Säure um etwaigen Schmutz (wie z.B.: Schlieren vom Fugenmaterial, Zement, etc.) zu beseitigen.

Für die alltägliche Pflege empfehlen wir die Verwendung von handelsüblichen Reinigungsmitteln. Beachten Sie bitte die Verdünnungsanweisung des Herstellers des Produktes.

Die Pflege und die Reinigung der keramischen Platten ist sehr einfach und sollte mit neutralen Putzmitteln durchgeführt werden.

Bitte befolgen Sie die Herstellerangaben zum Gebrauch des Produktes. Schleifmittel können zur Beschädigung der Dekore führen und sind daher zu vermeiden.

Genesis - Gold, Silver und Copper Stücke die durch die Ablagerung von Titanpartikeln - die ihnen einen metallischen Aspekt geben, verziert sind, sollten mit Vorsicht behandelt werden. Die Endreinigung und Wartung dieses Produkttyps sollte mit für Metalle geeigneten Reinigungsmitteln - Aufheller aus rostfreiem Stahl - durchgeführt werden, um eine antistatische Wirkung zu erzielen, die Schmutz abweisen und das Produkt vor Fetten und Korrosion schützen kann. Die regelmäßige Reinigung des Produkts sollte mit einem mit Wasser oder Glasreiniger angefeuchteten Tuch erfolgen. Nach dem Trocknen sollte man die Flächen mit einem trockenen Tuch abwischen.

ЗАЩИТА И ЧИСТКА

Все остатки клея и цементные затирки необходимо удалить с поверхности плиток сразу же после их нанесения и в соответствии с инструкциями производителя.

Непосредственно после укладки керамического материала рекомендуется принять меры по защите керамических изделий. После удаления загрязнений, возникших в ходе работы, таких как излишки прокладки, цементирования, и т.д., рекомендуется использовать буферную кислоту для удаления всех остатков.

В повседневной чистке можно использовать обычные моющие средства, соблюдая нормы разбавления, указанные изготовителем.

В том, что касается декорированных деталей, следует избегать использование абразивных моющих средств, поскольку они могут повредить детали.

С деталями, декорированными путем осаждения титановых частиц - коллекция Genesis, цвета gold, silver и соррер - придающих им металлический вид, необходимо обращаться осторожно. Их окончательная и повседневная мойка должна производиться моющими средствами, специально предназначенными для металлов (полирующий состав для нержавеющей стали), чтобы создать антистатический эффект для отражения грязи и защиты продукции от жирных веществ и коррозии. Регулярную очистку покрытия из керамогранита следует выполнять тряпкой, смоченной в воде или в чистящем средстве для стекол, а после того, как поверхность высохнет - протереть сухой тряпочкой.

ROTEZIONE E PULIZIA

Tutti i residui di adesivo e stucco devono essere rimossi dalla superficie delle piastrelle subito dopo l'applicazione e secondo le istruzioni del produttore.

Subito dopo la posa del materiale ceramico è consigliabile che le piastrelle in ceramica siano adeguatamente protette. Per rimuovere lo sporco di fine cantiere, come resti di fughe, cementi, ecc, si consiglia di utilizzare un disincrostante acido tamponato per rimuovere tutti i residui.

Nella manutenzione quotidiana possono essere utilizzati dei normali detergenti, secondo le diluizioni raccomandate dal rispettivo fabbricante.

Per quanto riguarda i pezzi decorati, evitare l'uso di detergenti abrasivi, poiché possono danneggiare i pezzi.

I pezzi decorati mediante la deposizione di particelle di titanio - Genesis: Gold, Silver, Copper - che danno loro un aspetto metallico devono essere maneggiati con cura. La pulizia finale e manutenzione di questo tipo di prodotto devono essere eseguite con detergenti per metalli - brillantante per acciaio inox - al fine di creare un effetto statico in grado di respingere la sporcizia e proteggere il prodotto dai grassi e dalla corrosione. La pulizia periodica del prodotto deve essere eseguita con un panno inumidito con acqua o detergente per vetri e, dopo l'asciugatura, passare un panno asciutto.

Para mais informações por favor consulte lovetiles.com

For further information please consult lovetiles.com

Pour plus d'informations consulter lovetiles.com

Weitere Informationen finden Sie unter: lovetiles.com

Для получения дополнительной информации заходите на lovetiles.com

Per ulteriori informazioni consultare lovetiles.com

Technical Specifications ▾

Calibers

Certification

General Sales Conditions

Laying Suggestions

Outdoor extra thick

Package

Pr(ect

Symbols

Technical Information

Informação Técnica

Technical Information | Information Technique | Technische Information | Техническая Информация | Informazione Tecnica

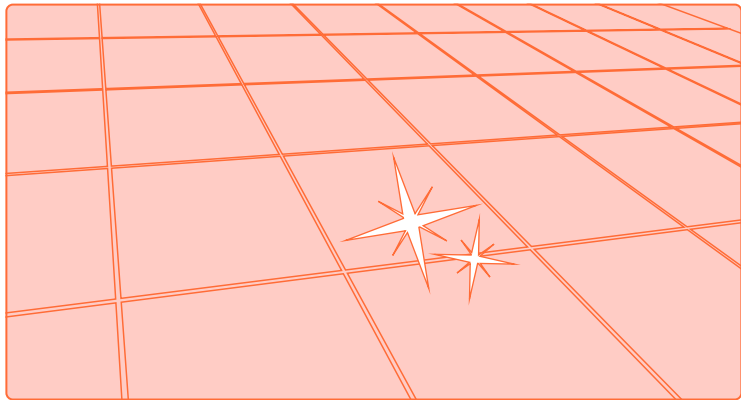

09

PRODUTOS POLIDOS

As peças das séries de acabamento polido e amaciado exigem um tratamento de aplicação e de manutenção especializadas.

O acabamento POLIDO, para além de ser aconselhado para revestimentos, é também indicado para pavimentos de ambientes residenciais ou comerciais de tráfego ligeiro, não sujeitos a elevada utilização, ou onde não sejam requeridas quaisquer prestações antiderrapantes. A presença esporádica de pequenas não uniformidades ou pontos na superfície deve ser considerada uma característica do material e do seu particular acabamento. Se o produto for colocado em contato direto com o exterior, recomenda-se o uso de soluções protetoras de modo a reduzir a possibilidade de formação de riscos. É da responsabilidade do instalador providenciar sempre a proteção das peças cerâmicas acabadas e limpas, antes da entrega ao cliente, utilizando materiais de proteção adequados (por ex. painéis de aglomerado, folhas de cartão, etc.).

Cola e Argamassa

Utilizar argamassas para betumação, de preferência de cor idêntica à cor do produto, e de acordo com a especificação do produto - grés.

Aplicação e primeira limpeza

Na sua aplicação deverá ter o máximo cuidado na remoção das argamassas utilizadas para rejuntar. A limpeza deve ser efetuada, enquanto as argamassas da junta ainda estiverem húmidas, com um pano ou esponja molhada, devendo-se evitar a utilização de detergentes abrasivos que poderão danificar as peças.

Caso as peças apresentem excesso seco de impermeabilizante, a melhor forma de o remover é, esfregando com papel ou pano limpo e seco, podendo essa limpeza ser realizada manualmente ou usando uma monoespátula apropriada.

Aconselhamos que esta limpeza seja realizada sem nenhum tipo de materiais abrasivos ou contaminantes. Uma eventual limpeza com produtos líquidos pode ser potenciadora na diminuição da eficácia do tratamento repelente e protetivo pretendido com a aplicação impermeabilizante.

Manutenção

A limpeza final e de manutenção do produto deverá ser feito com detergentes próprios para pavimento. Deverá ser usado detergente de alta concentração diluído conforme a indicação do fornecedor, e dependendo do grau de sujidade, a diluição do detergente poderá ter de ser bastante reduzida, podendo em alguns casos chegar à proporção de 1/3 (detergente/água).

Esfregar com um pano de limpeza de micro-fibra.

No caso de o produto apresentar muita sujidade, aconselhamos a que a limpeza seja feita manualmente. Em casos muito excecionais da não remoção da sujidade com o método apresentado acima, recomendamos o uso de uma espuma polimérica branca(1) usada apenas com água.

(1) Comercialmente conhecida como esponja mágica.

POLISHED PRODUCTS

The parts of POLISHED finishe series require specialized application and maintenance treatment. The POLISHED finishe are recommended, as well as for wall cladding, also for flooring in residential or light commercial areas that are not subjected to heavy traffic, where anti-slip characteristics are not required. The occasional presence of small inconsistencies or little spots on the surface is to be considered a characteristic of the material and of its unique production process. If the product is laid in direct contact with external environments, it is recommended to use protective solutions to reduce the formation of scratches.

Glue and Mortar

Preferably use mortars for grouting of color identical to the color of the product, and according to its specification - stoneware.

Application

In its application, you should take utmost care in removing the mortars used for grouting. Cleaning

must be carried out with a wet cloth or sponge while the joint mortars are still wet, and avoid the use of abrasive detergents that could damage the parts.

Protection and Cleaning

The final cleaning and maintenance of the product should be done with suitable detergents for floorings. Diluted highly concentrated detergent should be used in accordance with the supplier's instructions and, depending on the degree of dirt, dilution of the detergent may be greatly reduced and in some cases may reach the proportion of 1/3 (detergent / water).

Scrub with a micro-fiber cleaning cloth.

If the product is heavily soiled, we advise you to clean it manually.

In very exceptional cases of non-removal of dirt with the above presented method, we recommend the use of a white polymer foam (1) used only with water.

(1) Commercially known as magic sponge.

PRODUITS POLIS

Les pièces des séries à finition POLI nécessitent un traitement d'application et d'entretien spécialisé. En plus des revêtements, la finition POLI est également recommandée pour les sols dans les environnements résidentiels ou commerciaux légers peu soumis à des contraintes élevées, pour lesquels aucune prestation antidérapante n'est requise. La présence sporadique de petites irrégularités ou de points à la surface doit être considérée comme une caractéristique du matériau et de sa fabrication particulière. Si le produit est placé en contact direct avec l'extérieur, il est conseillé d'utiliser des solutions de protection afin d'éviter la formation de rayures. Dans les zones à passage de charges lourdes concentrées, l'utilisation de produits d'épaisseur réduite n'est pas recommandée.

Colle et mortier

Utilisez des mortiers pour le jointoiment, de préférence de couleur identique à celle du produit, et selon les spécifications du produit - grès.

Application

Lors de l'application, vous devez faire très attention à l'enlèvement des mortiers utilisés pour le jointement. Le nettoyage doit être effectué avec un chiffon humide ou une éponge, alors que les mortiers des joints sont encore humides, et on doit éviter l'utilisation de détergents abrasifs qui pourraient endommager les pièces.

Protection et nettoyage

Le nettoyage final et l'entretien du produit doivent être effectués avec des détergents appropriés pour les revêtements de sol.

On doit utiliser un détergent hautement concentré, dilué conformément aux instructions du fournisseur.

En fonction du degré de salissure, la dilution du détergent pourra être considérablement réduite et dans certains cas, elle peut atteindre la proportion de 1/3 (détergent/eau).

Frotter avec un chiffon de nettoyage en microfibre.

Si le produit est très sale, nous vous conseillons de le nettoyer à la main.

Dans les cas très exceptionnels de non-élimination de la saleté avec la méthode présentée ci-dessus, nous recommandons l'utilisation d'une mousse polymère blanche (1) utilisée uniquement avec de l'eau.

(1) Commerciallement appelée éponge magique.

POLIERE PRODUKTE

Die Serien Reihen mit POLIERTER Fertigstellung erfordern eine spezielle Anwendung und Wartung.

Die POLIERTEN Oberflächen werden nicht nur für Wandverkleidungen empfohlen, sondern auch für Böden in Wohn- bzw. Gewerbebereichen, die keiner hohen Belastung ausgesetzt sind und bei denen keine rutschhemmende Wirkung erforderlich ist. Das sporadische Vorhandensein von kleinen Unebenheiten oder Punkten auf der Oberfläche ist als ein Merkmal von Material und besonderer Verarbeitung zu betrachten. Wird das Produkt in direkten Kontakt mit der Außenseite gebracht, wird empfohlen, Schutzlösungen zu verwenden, um die Bildung von Kratzern zu vermeiden. In Bereichen, die schwerer Belastung ausgesetzt sind, ist die Verwendung von Produkten mit reduzierter Stärke nicht empfehlenswert.

Klebstoff und Mörtel

Verwenden Sie Betumenmasse, vorzugsweise mit einer Farbe, die mit der Farbe des Produkts identisch ist, und gemäß der Produktspezifikation - Steinzeug.

Anwendung und erste Reinigung

Sie sollten beim Entfernen des zur Ausfugung verwendeten Mörtels vorsichtig vorgehen. Die Reinigung sollte durchgeführt werden, solange der Fugenmörtel noch feucht ist. Verwenden Sie dazu ein feuchtes Tuch oder einen Schwamm und vermeiden Sie kratzenden oder scheuernden Mittel, die die Teile beschädigen könnten.

Wenn die Teile einen trockenen Überschuss an Abdichtung aufweisen, entfernen Sie sie am besten mit einem sauberen, trockenen Papiertuch oder einem Stofftuch. Diese Reinigung kann entweder manuell oder mit einem geeigneten Spatel erfolgen.

Wir empfehlen, bei dieser Reinigung keine Schleifmittel oder kontaminierenden Materialien zu verwenden. Wenn für die Reinigung flüssige Produkte verwendet werden, kann dies dazu führen, dass die gewünschte Wirksamkeit der abweisenden und schützenden Behandlung mit der wasserfesten Anwendung verringert wird.

Wartung

Die finale Reinigung und Pflege des Produkts muss mit für Fußböden geeigneten Reinigungsmitteln erfolgen. Es sollte ein hochkonzentriertes Reinigungsmittel verwendet werden, das gemäß den Anweisungen des Lieferanten verdünnt werden soll. Je nach Verschmutzungsgrad muss die Verdünnung des Waschmittels möglicherweise erheblich reduziert werden, in einigen Fällen mit einem Anteil von 1/3

(Reinigungsmittel / Wasser).

Mit einem Mikrofaser-Reinigungstuch einreiben.

Wenn das Produkt sehr schmutzig ist, empfehlen wir, es manuell zu reinigen.

In Ausnahmefällen, in denen mit der oben beschriebenen Methode der Schmutz nicht entfernt werden kann, empfehlen wir die Verwendung eines weißen Polymerschiums (1), der nur mit Wasser verwendet wird.

(1) Im Handel als magischer Schwamm bekannt.

ПОЛИРОВАННЫЕ ИЗДЕЛИЯ

Детали с полированной и отшлифованной поверхностью требуют специального применения и ухода. ПОЛИРОВАННАЯ поверхность, помимо того, что она идеально подходит для настенной плитки, также подходит и для напольной плитки в жилых или коммерческих помещениях с небольшой интенсивностью движения, не подверженных интенсивному использованию, где не требуются противоскользящая поверхность на полу. Незначительное присутствие мелких неровностей или пятен на поверхности следует рассматривать как характеристику материала и его особую отделку. Если продукт находится в прямом контакте с внешней средой, рекомендуется использовать защитные растворы, чтобы снизить вероятность возникновения микротрещин. Монтажник обязан всегда обеспечивать защиту керамических изделий, их чистоту перед доставкой их заказчику, используя подходящие защитные материалы (например, панели из ДСП, листы картона и т. д.).

Клей и цементный раствор

Использовать раствор для затирки швов желателно идентичному цвету материала и согласно спецификации продукции - керамограниту.

Нанесение материала и первая очистка

При его нанесении следует проявлять особую осторожность при удалении раствора, использованного для затирки швов. Очистку следует проводить влажной тканью или губкой, пока раствор для швов сохнет, избегая использования абразивных моющих средств, которые могут повредить поверхность материала.

Если на плитках обнаружен сухой излишек гидроизоляционного материала, то лучший способ удалить его - протереть чистой сухой бумагой или тканью. Это можно произвести вручную или с помощью подходящего моно шпателя.

Мы рекомендуем проводить эту очистку без использования каких-либо абразивных или загрязняющих средств.

Любая очистка жидкими средствами может снизить эффективность желаемого репеллента и защитной обработки с применением гидроизоляции.

Обслуживание

Окончательную очистку и уход за изделием следует проводить с помощью моющих средств, подходящих для напольных покрытий.

Следует использовать разбавленное моющее средство с высокой концентрацией, согласно указаниям поставщика, и, в зависимости от степени загрязнения, разбавление моющего средства может быть значительно уменьшено, в некоторых случаях достигая пропорции 1/3 (моющее средство/вода).

Протрите поверхность чистящей тканью из микрофибры.

Если материал окажется очень загрязненным, то советуем очистить его вручную.

В особо исключительных случаях, когда не удается удалить грязь описанным выше методом, мы рекомендуем использовать белую полимерную пену (1), применяемую исключительно с водой.

(1) Коммерчески известна как "волшебная" губка.

PRODOTTI LEVIGATI

La finitura LEVIGATI è consigliata, oltre che per rivestimenti, anche per pavimenti in ambienti residenziali o commerciale leggero non sottoposti ad elevate sollecitazioni, ove non siano richieste prestazioni antiscivolo. La presenza sporadica di piccole disuniformità o di puntini sulla superficie è da ritenersi come caratteristica del materiale e della particolare lavorazione. Qualora il prodotto sia posto a diretto contatto con l'esterno, si consiglia di utilizzare soluzioni protettive al fine di prevenire la formazione di graffi. E' responsabilità del posatore provvedere sempre alla protezione della piastrellatura finita e pulita, prima della consegna al committente, tramite appositi materiali protettivi (es. pannelli in truciolare, fogli di cartone, ecc.).

Colla e Malta

Utilizzare malta per stuccatura, preferibilmente dello stesso colore del prodotto e secondo le specifiche del prodotto - grés.

Posa

Nella posa, adottare la massima cura nel rimuovere la malta usata per la stuccatura. La pulizia deve essere eseguita mentre la malta del giunto è ancora umida, con una spugna o un panno bagnato, evitando l'uso di detergenti forti che possono danneggiare le parti.

Protezione e Pulizia

La pulizia finale e manutenzione del prodotto dovrebbero essere eseguite con l'apposito detergente per pavimenti.

Deve essere usato un detergente ad alta concentrazione diluito secondo le indicazioni del fornitore e, a seconda del grado di sporco, la diluizione del detergente può essere notevolmente ridotta e, in alcuni casi, può raggiungere un rapporto di 1/3 (detergente/acqua). Strofinare con un panno in microfibra. Se il prodotto è molto sporco, si consiglia una pulizia manuale.

In casi eccezionali, qualora non sia possibile rimuovere lo sporco con il metodo di cui sopra, si consiglia di utilizzare una schiuma polimerica bianca(1) solo con acqua.

(1) Commercialmente conosciuta come spugna magica

Technical Information | Information Technique | Technische Information | Техническая Информация | Informazione Tecnica

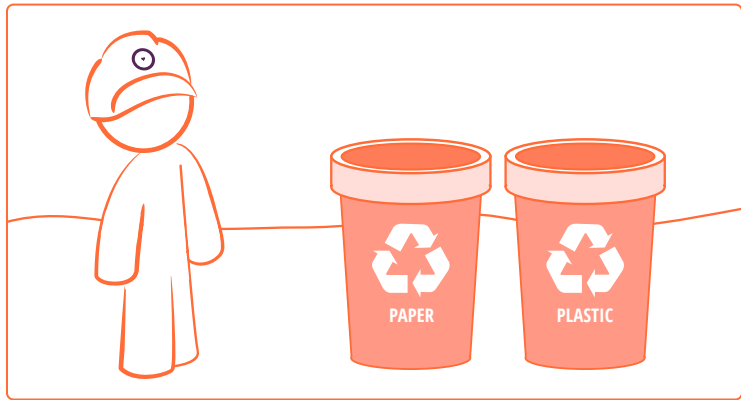

10

CICLO DE VIDA

Os impactos ambientais dos nossos produtos distribuem-se ao longo do seu ciclo de vida, nas etapas extração, transporte de matérias-primas, produção, distribuição, uso e fim de vida. A Love Tiles minimiza estes impactos ambientais, através de boas práticas de gestão ambiental.

No uso e fim de vida, apelamos à vossa melhor gestão, privilegiando a reutilização ou a reciclagem numa perspetiva de economia circular.

LIFE CYCLE

The environmental impacts of our products are distributed through their life cycle complying extraction, raw materials transport, production, distribution, use and end of life. Love Tiles minimize these impacts through good practices of environmental management. At the end of the product 's life cycle, Love Tiles asks for your best management, favoring the reuse or recycling in a perspective of a circular economy.

CYCLE DE VIE

Les impacts environnementaux de nos produits sont distribués tout au long de leur cycle de vie, dans les phases d'extraction, de transport des matières premières, de production, de distribution, d'utilisation et de fin de vie. Chez Love Tiles on minimise ces impacts environnementaux grâce aux bonnes pratiques de gestion de l'environnement.

Dans l'utilisation et la fin de vie, on appel à votre meilleure gestion en privilégiant la réutilisation ou le recyclage dans une perspective d'économie circulaire.

LEBENSZYKLUS

Die Umweltbelastung unserer Produkte prägt jede Phase ihres Lebenszyklus – die Gewinnung und das Transport der Rohstoffe, die Produktion, die Lieferung, der Gebrauch, die Entsorgung. Love Tiles verniedlicht durch gute Programme des Umweltmanagements die Umweltbelastung. In der Phase des Gebrauchs und der Entsorgung bitten wir Sie um eine bevorzugte Auswahl von Weiterverwenden oder Recycling.

ЖИЗНЕННЫЙ ЦИКЛ

Экологические воздействия влияют на нашу продукцию на протяжении всего жизненного цикла, на этапах добычи, транспортировки сырья, производства, дистрибуции, использования и окончания срока службы. Love Tiles минимизирует данные экологические воздействия и последствия благодаря хорошей практике управления окружающей средой. В использовании продукции мы призываем вас следить за окружающей средой, отдавая предпочтение повторному использованию материала или его переработке.

CICLO DI VITA

L'impatto ambientale dei nostri prodotti si distribuisce durante il loro ciclo di vita, nelle tappe di estrazione e trasporto delle materie prime, produzione, distribuzione, uso e smaltimento. La Love Tiles minimizza tutto ciò, attraverso buone pratiche di gestione ambientale.

Nell'uso e nello smaltimento, ci appelliamo alla vostra gestione, perché privilegiate il riuso o il riciclaggio in una prospettiva di economia circolare.

Index ▼

Colour Map ▼

Collections ▼

Technical Specifications

Calibers

Certification

General Sales Conditions

Laying Suggestions

Outdoor extra thick

Package

Pr(ect

Symbols

Technical Information

Informação Técnica

Technical Information | Information Technique | Technische Information | Техническая Информация | Informazione Tecnica

REVESTIMENTO MONOPOROSA | SINGLE FIRED WALL TILES | FAÏENCES MONOCOISSON
WEIßSCHERBIGE STEINGUTFLIESEN | ОБЛИЦОВОЧНАЯ ОДНОКРАТНОГО ОБЖИГА | RIVESTIMENTO MONOPOROSA

EN14411: ANEXO | ANNEX | ANNEXE | ANHANG | ПРИЛОЖЕНИЕ | ALLEGATO L GRUPO | GROUP | GROUPE | GRUPPE | КЛАСС | GRUPPO BIII
ISO 13006: ANEXO | ANNEX | ANNEXE | ANHANG | ПРИЛОЖЕНИЕ | ALLEGATO L GRUPO | GROUP | GROUPE | GRUPPE | КЛАСС | GRUPPO BIII

CARACTERÍSTICAS TÉCNICAS TECHNICAL FEATURES CARACTÉRISTIQUES TECHNIQUES TECHNISCHE EIGENSCHAFTEN ТЕХНИЧЕСКИЕ ХАРАКТЕРИСТИКИ CARATTERISTICHE TECNICHE	NORMA TEST METHOD MÉTHODE D'ESSAI PRUEFMETHODE NORMA METODO DI PROVA	VALOR PRESCRITO PRESCRIBED VALUE VALEUR PRESCRITE VORGESCHRIEBENER WERT ЗАВЯЛЕННЫЙ ОБЪЕМ VALORE PRESCRITTO	
Dimensão - Comprimento e largura Size - Length and width Dimension - Longueur et largeur Abmessungen - Länge und breite Размер - длина и ширина Dimensione - Lunghezza e larghezza	EN ISO 10545-2	Non Rect. ± 0,6%, max ± 2,0 mm Rect. ± 0,3%, max ± 1,0 mm	Conforme Conform Conforme Gemäß Соответствует Conforme
Rectilinearidade das arestas Side straightness Rectitude des arêtes Kantengeradheit Прямолинейность лицевых граней Rettilinearität spigoli		Non Rect. ± 0,5%, max ± 2 mm Rect. ± 0,3%, max ± 1,5 mm	Conforme Conform Conforme Gemäß Соответствует Conforme
Ortogonalidade Rectangularity Orthogonalité Rechtwinkligkeit Ортогональность (кривизна сторон) Ortogonalità		Non Rect. ± 0,5%, max ± 2,0 mm Rect. ± 0,3%, max ± 1,5 mm	Conforme Conform Conforme Gemäß Соответствует Conforme
Planariedade Warpage Planéité Ebenflächigkeit Планирность (кривизна поверхности) Planarità		Non Rect. ± 0,5%, max ± 2,0 mm Rect. ± 0,4%, max ± 1,8 mm	Conforme Conform Conforme Gemäß Соответствует Conforme
Empeno Warpage Gauchissement Krümmung Искривление Sghembo		Non Rect. ± 0,5%, max ± 2,0 mm Rect. ± 0,4%, max ± 1,8 mm	Conforme Conform Conforme Gemäß Соответствует Conforme
Espessura Thickness Épaisseur Dicke Толщина Spessore		± 10% , max ± 0,5 mm	Conforme Conform Conforme Gemäß Соответствует Conforme
Absorção de água (E) Water absorption (E) Absorption d'eau (E) Wasseraufnahme (E) Водопоглощение (E) Assorbimento d'acqua (E)	EN ISO 10545-3	E > 10%	Conforme Conform Conforme Gemäß Соответствует Conforme
Módulo de ruptura Modulus of rupture Module de rupture Biegung modul Предел прочности на изгиб Modulo di rottura	EN ISO 10545-4	≥ 12 N/mm ²	Conforme Conform Conforme Gemäß Соответствует Conforme
Resistência à flexão (S) Breaking strength (S) Résistance à la flexion (S) Biegefestigkeit (S) Прочность на изгиб Resistenza alla flessione		S ≥ 600 N	Conforme Conform Conforme Gemäß Соответствует Conforme
Dilatação térmica linear Linear thermal expansion Dilatation thermique linéaire Lineare Wärmeausdehnung Линейное тепловое расширение Dilatazione termica lineare	EN ISO 10545-8	Conforme indicado pelo fabricante As indicated by manufacturer Comme indiqué par le producteur Wie vom Hersteller angegeben В соответствии с указанием производителя Come indicato dal produttore	$\alpha \leq 7,5 \times 10^{-6} \text{ } ^\circ\text{C}^{-1}$ Valor máximo Maximum value Valeur maximum Maximalwert Максимальные показатели Valore massimo
Resistência ao choque térmico Thermal shock resistance Résistance aux chocs thermiques Temperaturwechselbeständigkeit Устойчивость к температурным перепадам Resistenza agli sbalzi termici	EN ISO 10545-9	Exigido Required Demandé Anforderung Востребовано Richiesto	Resistente Resistant Résistant Beständig Стойкий Resistente
Resistência ao fendilamento Cracking resistance Résistance aux tré sillures Haarriß Beständigkeit Устойчивость к растрескиванию Resistenza alla fessurazione	EN ISO 10545-11	Exigido Required Demandé Anforderung Востребовано Richiesto	Resistente Resistant Résistant Beständig Стойкий Resistente
Resistência aos ácidos e bases Resistance against acids and alkalis Résistance aux acides et aux alcalis Bestaend. Gegen saeuren u. Laugen Устойчивость к воздействию кислот и щелочей Resistenza agli acidi e alle basi	EN ISO 10545-13	Conforme indicado pelo fabricante As indicated by manufacturer Comme indiqué par le producteur Wie vom Hersteller angegeben В соответствии с указанием производителя Come indicato dal produttore	GLB
Resistência aos produtos de limpeza domésticos Resistance to household cleaning proucts Résistance aux produits domestiques de nettoyage Bestaendig. G.Haushaltsreinigungsprodukte Устойчивость к бытовой химии Resistenza ai prodotti di pulizia di uso domestico		Mínimo: GB Minimum: GB Minimum: GB Minimum: GB Минимум: GB Mínimo: GB	Conforme Conform Conforme Gemäß Соответствует Conforme
Resistência às manchas Stain Resistance Résistance aux taches Bestaendigkeit gegen flecken Устойчивость к появлению пятен Resistenza alle macchie	EN ISO 10545-14	Mínimo: classe 3 Minimum: class 3 Minimum: classe 3 Minimum: Klasse 3 Минимум: класс 3 Mínimo: classe 3	Conforme Conform Conforme Gemäß Соответствует Conforme

É garantido o cumprimento da norma EN 14411_Group BIII. O valor típico anunciado é meramente indicativo, podendo variar dos dados reais, não tendo a natureza de proposta negocial. | It is guaranteed the compliance with the values required by norm EN 14411_Group BIII. Typical Value is merely indicative, which can vary from real data, and does not have the purpose of any trading proposal. | Le respect de la norma EN14411_Group BIII est garanti. La valeur typique annoncée étant indicative, pouvant varier de la valeur réelle, n'ayant pas la nature d'une proposition à caractère. | Es wird die Einhaltung der in der Norm EN 14411_Group BIII geforderten Werte garantiert. Der angegebene Wert ist lediglich ein Richtwert, der von den tatsächlichen Daten abweichen kann und nicht Teil des Handelsvertrages darstellt. | Соответствие стандарту EN 14411_Group BIII гарантируется. Заявленное значение является лишь ориентировочным и может отличаться от фактических данных, без возможности согласования с коммерческим предложением. | È garantita la conformità secondo la norma EN 14411_Group BIII. Il valore tipico pubblicizzato è puramente indicativo, potendo variare rispetto ai dati reali, non avendo la natura di una proposta di negoziazione.

As características técnicas declaradas neste catálogo, não invalidam a consulta de informação atualizada no site e Fichas Técnicas. | The technical characteristics stated in this catalogue do not invalidate the consultation of updated information on the website and technical data sheets. | Les caractéristiques techniques déclarées dans ce catalogue n'empêchent pas la consultation de l'information à jour dans le site web et fiches techniques. | Die in diesem Katalog angegebenen technischen Eigenschaften verzichtet nicht auf das Lesen der aktualisierten Informationen und der technischen Datenblätter auf der Website. | Технические характеристики, заявленные в этом каталоге, не отменяют обновленную информацию на веб-сайте и в таблицах с техническими данными. | Le caratteristiche tecniche indicate nel presente catalogo non invalidano la consultazione delle informazioni aggiornate sul sito web e schede tecniche.

Informação Técnica

Technical Information | Information Technique | Technische Information | Техническая Информация | Informazione Tecnica

GRÉS VIDRADO | GLAZED PORCELAIN TILES | GRÈS CÉRAME ÉMAILLÉ
FEINSTEINZEUG GLASIERT | КЕРАМОГРАНИТ ГЛАЗУРОВАННЫЙ | GRES SMALTATO

EN14411: ANEXO | ANNEX | ANNEXE | ANHANG | ПРИЛОЖЕНИЕ | ALLEGATO G GRUPO | GROUP | GROUPE | GRUPPE | КЛАСС | GRUPPO BIA GL
ISO 13006: ANEXO | ANNEX | ANNEXE | ANHANG | ПРИЛОЖЕНИЕ | ALLEGATO G GRUPO | GROUP | GROUPE | GRUPPE | КЛАСС | GRUPPO BIA GL

CARACTERÍSTICAS TÉCNICAS TECHNICAL FEATURES CARACTÉRISTIQUES TECHNIQUES TECHNISCHE EIGENSCHAFTEN ТЕХНИЧЕСКИЕ ХАРАКТЕРИСТИКИ CARATTERISTICHE TECNICHE	NORMA TEST METHOD MÉTHODE D'ESSAI PRUEFMETHODE NORMA METODO DI PROVA	VALOR PRESCRITO PRESCRIBED VALUE VALEUR PRESCRITE VORGESCHRIEBENER WERT ЗАВЯЛЕННЫЙ ОБЪЕМ VALORE PRESCRITTO	
Dimensão - Comprimento e largura Size - Length and width Dimension - Longueur et largeur Abmessungen - Länge und breite Размер - длина и ширина Dimensione - Lunghezza e larghezza	EN ISO 10545-2	Non Rect. ± 0,6%, max ± 2,0 mm Rect. ± 0,3%, max ± 1,0 mm	Conforme Conform Conforme Gemäß Соответствует Conforme
Rectilinearidade das arestas Side straightness Rectitude des arêtes Kantengeradheit Прямолинейность лицевых граней Rettilinearität spigoli		Non Rect. ± 0,5%, max ± 2 mm Rect. ± 0,3%, max ± 1,5 mm	Conforme Conform Conforme Gemäß Соответствует Conforme
Ortogonalidade Rectangularity Orthogonalité Rechtwinkligkeit Ортогональность (кривизна сторон) Ortogonalità		Non Rect. ± 0,5%, max ± 2,0 mm Rect. ± 0,3%, max ± 1,5 mm	Conforme Conform Conforme Gemäß Соответствует Conforme
Planariedade Warpage Planéité Ebenflächigkeit Планирность (кривизна поверхности) Planarità		Non Rect. ± 0,5%, max ± 2,0 mm Rect. ± 0,4%, max ± 1,8 mm	Conforme Conform Conforme Gemäß Соответствует Conforme
Espessura Thickness Épaisseur Dicke Толщина Spessore			± 5% max ± 0,5 mm
Absorção de água (E) Water absorption (E) Absorption d'eau (E) Wasseraufnahme (E) Водопоглощение (E) Assorbimento d'acqua (E)	EN ISO 10545-3	E ≤ 0,5%	Conforme Conform Conforme Gemäß Соответствует Conforme
Módulo de ruptura Modulus of rupture Module de rupture Biegung modul Предел прочности на изгиб Modulo di rottura	EN ISO 10545-4	≥ 35 N/mm ²	Conforme Conform Conforme Gemäß Соответствует Conforme
Resistência à flexão (S) Breaking strength (S) Résistance à la flexion (S) Biegefestigkeit (S) Прочность на изгиб Resistenza alla flessione		S ≥ 1300 N	Conforme Conform Conforme Gemäß Соответствует Conforme
Resistência à abrasão Abrasion resistance Résistance à l'abrasion Abriebwiderstand Устойчивость Resistenza all'abrasione	EN ISO 10545-7	Conforme indicado pelo fabricante As indicated by manufacturer Comme indiqué par le producteur Wie vom Hersteller angegeben В соответствии с указанием производителя Come indicato dal produttore	2-4
Dilatação térmica linear Linear thermal expansion Dilatation thermique linéaire Lineare Wärmeausdehnung Линейное тепловое расширение Dilatazione termica lineare	EN ISO 10545-8	Conforme indicado pelo fabricante As indicated by manufacturer Comme indiqué par le producteur Wie vom Hersteller angegeben В соответствии с указанием производителя Come indicato dal produttore	$\alpha \leq 7,5 \times 10^{-6} \text{ } ^\circ\text{C}^{-1}$ Valor máximo Maximum value Valeur maximum Maximalwert Максимальные показатели Valore massimo
Resistência ao choque térmico Thermal shock resistance Résistance aux chocs thermiques Temperaturwechselbeständigkeit Устойчивость к температурным перепадам Resistenza agli sbalzi termici	EN ISO 10545-9	Exigido Required Demandé Anforderung Востребовано Richiesto	Resistente Resistant Résistant Beständig Стойкий Resistente
Resistência ao fendilamento Cracking resistance Résistance aux tré sillures Haarriß Beständigkeit Устойчивость к растрескиванию Resistenza alla fessurazione	EN ISO 10545-11	Exigido Required Demandé Anforderung Востребовано Richiesto	Resistente Resistant Résistant Beständig Стойкий Resistente
Resistência aos ácidos e bases Resistance against acids and alkalis Résistance aux acides et aux alcalis Bestaend. Gegen saeuren u. Laugen Устойчивость к воздействию кислот и щелочей Resistenza agli acidi e alle basi	EN ISO 10545-13	Conforme indicado pelo fabricante As indicated by manufacturer Comme indiqué par le producteur Wie vom Hersteller angegeben В соответствии с указанием производителя Come indicato dal produttore	GLB
Resistência aos produtos de limpeza domésticos Resistance to household cleaning proucts Résistance aux produits domestiques de nettoyage Bestaendig. G.Haushaltsreinigungsprodukte Устойчивость к бытовой химии Resistenza ai prodotti di pulizia di uso domestico		Mínimo: GB Minimum: GB Minimum: GB Minimum: GB Минимум: GB Mínimo: GB	Conforme Conform Conforme Gemäß Соответствует Conforme
Resistência às manchas Stain Resistance Résistance aux taches Bestaendigkeit gegen flecken Устойчивость к появлению пятен Resistenza alle macchie	EN ISO 10545-14	Mínimo: classe 3 Minimum: class 3 Minimum: classe 3 Minimum: Klasse 3 Минимум: класс 3 Mínimo: classe 3	Conforme Conform Conforme Gemäß Соответствует Conforme

É garantido o cumprimento da norma EN 14411_Group BIA GL. O valor típico anunciado é meramente indicativo, podendo variar dos dados reais, não tendo a natureza de proposta negocial. | It is guaranteed the compliance with the values required by norm EN 14411_Group BIA GL. Typical Value is merely indicative, which can vary from real data, and does not have the purpose of any trading proposal. | Le respect de la norma EN14411_Group BIA GL est garanti. La valeur typique annoncée étant indicative, pouvant varier de la valeur réelle, n'ayant pas la nature d'une proposition à caractère. | Es wird die Einhaltung der in der Norm EN 14411_Group BIA GL geforderten Werte garantiert. Der angegebene Wert ist lediglich ein Richtwert, der von den tatsächlichen Daten abweichen kann und nicht Teil des Handelsvertrages darstellt. | Соответствие стандарту EN 14411_Group BIA GL гарантируется. Заявленное значение является лишь ориентировочным и может отличаться от фактических данных, без возможности согласования с коммерческим предложением. | È garantita la conformità secondo la norma EN 14411_Group BIA GL. Il valore tipico pubblicizzato è puramente indicativo, potendo variare rispetto ai dati reali, non avendo la natura di una proposta di negoziazione.

As características técnicas declaradas neste catálogo, não invalidam a consulta de informação atualizada no site e Fichas Técnicas. | The technical characteristics stated in this catalogue do not invalidate the consultation of updated information on the website and technical data sheets. | Les caractéristiques techniques déclarées dans ce catalogue n'empêchent pas la consultation de l'information à jour dans le site web et fiches techniques. | Die in diesem Katalog angegebenen technischen Eigenschaften verzichtet nicht auf das Lesen der aktualisierten Informationen und der technischen Datenblätter auf der Website. | Технические характеристики, заявленные в этом каталоге, не отменяют обновленную информацию на веб-сайте и в таблицах с техническими данными. | Le caratteristiche tecniche indicate nel presente catalogo non invalidano la consultazione delle informazioni aggiornate sul sito web e schede tecniche.

Technical Specifications

Calibers

Certification

General Sales Conditions

Laying Suggestions

Outdoor extra thick

Package

Pr()tect

Symbols

Technical Information

Informação Técnica

Technical Information | Information Technique | Technische Information | Техническая Информация | Informazione Tecnica

GRÉS NÃO VIDRADO | UNGLAZED PORCELAIN TILES | GRÈS CÉRAME NON ÉMAILLÉ
FEINSTEINZEUG UNGLASIERT | НЕГЛАЗУРОВАННЫЙКЕРАМОГРАНИТ | GRES NON VIDRATO

EN14411: **ANEXO | ANNEX | ANNEXE | ANHANG | ПРИЛОЖЕНИЕ | ALLEGATO** **G** **GRUPO | GROUP | GROUPE | GRUPPE | КЛАСС | GRUPPO** **BIA UGL**
ISO 13006: **ANEXO | ANNEX | ANNEXE | ANHANG | ПРИЛОЖЕНИЕ | ALLEGATO** **G** **GRUPO | GROUP | GROUPE | GRUPPE | КЛАСС | GRUPPO** **BIA UGL**

CARACTERÍSTICAS TÉCNICAS TECHNICAL FEATURES CARACTÉRISTIQUES TECHNIQUES TECHNISCHE EIGENSCHAFTEN ТЕХНИЧЕСКИЕ ХАРАКТЕРИСТИКИ CARATTERISTICHE TECNICHE	NORMA TEST METHOD MÉTHODE D'ESSAI PRUEFMETHODE НОРМА METODO DI PROVA	VALOR PRESCRITO PRESCRIBED VALUE VALEUR PRESCRITE VORGESCHRIEBENER WERT ЗАВЯЛЕННЫЙ ОБЪЁМ VALORE PRESCRITTO	LOVE CERAMIC TILES
Dimensão - Comprimento e largura Size - Length and width Dimension - Longueur et largeur Abmessungen - Länge und breite Размер - длина и ширина Dimensione - Lunghezza e larghezza		Non Rect. ± 0,6% , max ± 2 mm Rect. ± 0,3% , max ± 1 mm	Conforme Conform Conforme Gemäß Соответствует Conforme
Rectilinearidade das arestas Side straightness Rectitude des arêtes Kantengeradheit Прямолнейность лицевых граней Rettilinearità spigoli		Non Rect. ± 0,5% , max ± 2 mm Rect. ± 0,3% , max ± 1,5 mm	Conforme Conform Conforme Gemäß Соответствует Conforme
Ortogonalidade Rectangularity Orthogonalité Rechtwinkligkeit Ортогoнальность (кривизна сторон) Ortogonalità	EN ISO 10545-2	Non Rect. ± 0,5% , max ± 2 mm Rect. ± 0,3% , max ± 1,5 mm	Conforme Conform Conforme Gemäß Соответствует Conforme
Planariedade Warpage Planéité Ebenflächigkeit Планирность (кривизна поверхности) Planarità		Non Rect. ± 0,5% , max ± 2 mm Rect. ± 0,4% , max ± 1,8 mm	Conforme Conform Conforme Gemäß Соответствует Conforme
Espessura Thickness Épaisseur Dicke Толщина Spessore		± 5% max ± 0,5 mm	Conforme Conform Conforme Gemäß Соответствует Conforme
Absorção de água (E) Water absorption (E) Absorption d'eau (E) Wasseraufnahme (E) Водопоглощение (E) Assorbimento d'acqua (E)	EN ISO 10545-3	E ≤ 0,5%	Conforme Conform Conforme Gemäß Соответствует Conforme
Módulo de ruptura Modulus of rupture Module de rupture Biegung modul Предел прочности на изгиб Modulo di rottura	EN ISO 10545-4	≥ 35 N/mm ² S ≥ 1300 N	Conforme Conform Conforme Gemäß Соответствует Conforme
Resistência à flexão (S) Breaking strength (S) Résistance à la flexion (S) Biegefestigkeit (S) Прочность на изгиб Resistenza alla flessione		S ≥ 1300 N	Conforme Conform Conforme Gemäß Соответствует Conforme
Resistência à abrasão Abrasion resistance Résistance à l'abrasion Abrieb widerstand Устойчивость Resistenza all'abrasione	EN ISO 10545-6	≤ 175mm ³	Conforme Conform Conforme Gemäß Соответствует Conforme
Dilatação térmica linear Linear thermal expansion Dilatation thermique linéaire Lineare Wärmeausdehnung Линейное тепловое расширение Dilatazione termica lineare	EN ISO 10545-8	Conforme indicado pelo fabricante As indicated by manufacturer Comme indiqué par le producteur Wie vom Hersteller angegeben В соответствии с указанием производителя Come indicato dal produttore	α ≤ 7,5x10 ⁻⁶ °C ⁻¹ Valor máximo Maximum value Valeur maximum Maximalwert Максимальные показатели Valore massimo
Resistência ao choque térmico Thermal shock resistance Résistance aux chocs thermiques Temperaturwechselbeständigkeit Устойчивость к температурным перепадам Resistenza agli sbalzi termici	EN ISO 10545-9	Exigido Required Demandé Anforderung Востребовано Richiesto	Resistente Resistant Résistant Beständig Стойкий Resistente
Resistência ao fendilhamento Crazying resistance Résistance aux trésaillures Haarriß Beständigkeit Устойчивость к растрескиванию Resistenza alla fessurazione	EN ISO 10545-11	Exigido Required Demandé Anforderung Востребовано Richiesto	Resistente Resistant Résistant Beständig Стойкий Resistente
Resistência ao gelo Frost resistance Résistance au gel Frostbeständigkeit Морозоустойчивость Resistenza al gelo	EN ISO 10545-12	Exigido Required Demandé Anforderung Востребовано Richiesto	Resistente Resistant Résistant Beständig Стойкий Resistente
Resistência aos ácidos e bases Resistance against acids and alkalis Résistance aux acides et aux alcalis Bestaend. Gegen saeuren u. Laugen Устойчивость к воздействию кислот и щелочей Resistenza agli acidi e alle basi	EN ISO 10545-13	Conforme indicado pelo fabricante As indicated by manufacturer Comme indiqué par le producteur Wie vom Hersteller angegeben В соответствии с указанием производителя Come indicato dal produttore	ULB
Resistência aos produtos de limpeza domésticos Resistance to household cleaning procuts Résistance aux produits domestiques de nettoyage Bestaendig. G.Haushaltsreinigungsprodukte Устойчивость к бытовой химии Resistenza ai prodotti di pulizia di uso domestico		Mínimo: UB Minimum: UB Minimum: UB Minimum: UB Минимум: UB Minimo : UB	Conforme Conform Conforme Gemäß Соответствует Conforme
Resistência às manchas Stain Resistance Résistance aux taches Bestaendigkeit gegen flecken Устойчивость к появлению пятен Resistenza alle macchie	EN ISO 10545-14	Conforme indicado pelo fabricante As indicated by manufacturer Comme indiqué par le producteur Wie vom Hersteller angegeben В соответствии с указанием производителя Come indicato dal produttore	Conforme Conform Conforme Gemäß Соответствует Conforme

É garantido o cumprimento da norma EN 14411_Group BIA UGL. O valor típico anunciado é meramente indicativo, podendo variar dos dados reais, não tendo a natureza de proposta negocial. | It is guaranteed the compliance with the values required by norm EN 14411_Group BIA UGL. Typical Value is merely indicative, which can vary from real data, and does not have the purpose of any trading proposal. | Le respect de la norme EN14411_Group BIA UGL est garanti. La valeur typique annoncée étant indicative, pouvant varier de la valeur réelle, n'ayant pas la nature d'une proposition à caractère. | Es wird die Einhaltung der in der Norm EN 14411_Group BIA UGL geforderten Werte garantiert. Der angegebene Wert ist lediglich ein Richtwert, der von den tatsächlichen Daten abweichen kann und nicht Teil des Handelsvertrages darstellt. | Соответствие стандарту EN 14411_Group BIA UGL гарантируется. Заявленное значение является лишь ориентировочным и может отличаться от фактических данных, без возможности согласования с коммерческим предложением. | È garantita la conformità secondo la norma EN 14411_Group BIA UGL. Il valore tipico pubblicizzato è puramente indicativo, potendo variare rispetto ai dati reali, non avendo la natura di una proposta di negoziazione.

As características técnicas declaradas neste catálogo, não invalidam a consulta de informação atualizada no site e Fichas Técnicas. | The technical characteristics stated in this catalogue do not invalidate the consultation of updated information on the website and technical data sheets. | Les caractéristiques techniques déclarées dans ce catalogue n'empêchent pas la consultation de l'information à jour dans le site web et fiches techniques. | Die in diesem Katalog angegebenen technischen Eigenschaften verzichtet nicht auf das Lesen der aktualisierten Informationen und der technischen Datenblätter auf der Website. | Технические характеристики, заявленные в этом каталоге, не отменяют обновленную информацию на веб-сайте и в таблицах с техническими данными. | Le caratteristiche tecniche indicate nel presente catalogo non invalidano la consultazione delle informazioni aggiornate sul sito web e schede tecniche.

Informação Técnica

Technical Information | Information Technique | Technische Information | Техническая Информация | Informazione Tecnica

RESISTÊNCIA AO ESCORREGAMENTO | SLIPPING RESISTANCE | RÉSISTANCE À LA GLISSANCE | RUTSCHFESTIGKEIT | СОПРОТИВЛЕНИЕ СКОЛЬЖЕНИЮ | RESISTENZA ALLO SCIVOLAMENTO

	R9	R10	R11	R12	R13
---	-----------	------------	------------	------------	------------

ANTIDERRAPANTE
Em zonas de risco de escorregamento, a aplicação de material antiderrapante reduz consideravelmente o risco de escorregamento.
Alguns dos indicadores usados na medida do coeficiente de fricção são:

DIN EN 16165
ANEXO B – o ângulo de inclinação atingido durante o teste de resistência ao escorregamento. Esta norma determina as propriedades antiderrapantes dos pavimentos utilizados em lugares onde se transita com pés calçados.
ANEXO A - norma que se utiliza para zonas húmidas com possibilidade de circular de pé descalço (zonas de piscina, balneários, etc)
ANEXO C - o teste é feito na forma horizontal pois foi desenhado para replicar o contacto do pé com o solo até ao ponto onde o maior escorregamento pode ocorrer.

ANTI-SLIP
In areas at risk of slipping, the application of non-slip / anti-slip material greatly reduces the risk of slipping.
Some (of the) indicators used in the measurement of coefficient of friction are:

DIN EN 16165
ANNEX B - the angle of inclination achieved/reached during the slip resistance test. This standard determines the properties of non-slip/anti-slip flooring used in places where one walks with shod feet.
ANNEX A - standard that is used for wetland areas with the possibility of one walking barefoot (pool areas, changing rooms, etc.)
ANNEX C - the test is done horizontally because it was designed to replicate a pedestrian heel strike, the point at which most slips occur.

ANTIDÉRAPANT
Dans des zones présentant un risque de glissement, l'application de matériau antidérapant réduit considérablement ce risque.
Certains des indicateurs utilisés pour la mesure du coefficient de frottement sont:

DIN EN 16165
ANNEXE B – l'angle d' inclinaison atteint pendant le test de résistance au glissement
Cette norme détermine les propriétés antidérapantes des revêtements de sols utilisés dans des lieux de circulation avec les pieds chaussés.
ANNEXE A - norme qui est utilisée pour les zones humides où il est possible de circuler pieds nus (zones de piscine, vestiaires, etc.)
ANNEXE C - ce test est fait à l'horizontale puisqu'il a été conçu pour repliquer le contact du pied avec le sol jusqu'au point où le plus de glissance peut survenir.

RUTSCHSICHERE FLIESEN
In Räumen und Bereichen mit Rutschgefahr ist der Einsatz von rutschsicheren Fliesen ratsam, da diese das Rutschrisiko beträchtlich hemmen.
Bei der Prüfung der rutschhemmenden Eigenschaft gelten die folgenden Begriffe:
DIN EN 16165
ANHANG B - akzeptanzwinkel, d.h. Neigungswinkel der schiefen Ebene, bei dem die Prüfung bestanden wird. Die Norm bestimmt die rutschhemmende Eigenschaft von Bodenbelägen in Bereichen, in denen man Schuhe trägt.
ANHANG A - norm für nassbelastete Barfußbereiche (Schwimmbad, Umkleieräume, etc)
ANHANG C - er wird in der Waagerechten durchgeführt, weil er den Fußkontakt eines Fußgängers an dem Punkt mit der höchsten Rutschgefahr simulieren soll.

ПРЕДОХРАНЕНИЕ ОТ СКОЛЬЖЕНИЯ
В местах с риском скольжения использование материала против скольжения значительно уменьшает риск скольжения.
При измерении коэффициента трения используют также следующие показатели:
DIN EN 16165
ПРИЛОЖЕНИЕ В – максимальный угол наклона, достигнутый при тесте на сопротивление скольжению. Этот стандарт определяет свойства сопротивления скольжению покрытий, используемых на площадях, где происходит передвижение в обуви.
ПРИЛОЖЕНИЕ А - Стандарты, применяемые для влажных поверхностей, где возможно передвижение босиком (бассейны, сауны, итд.)
ПРИЛОЖЕНИЕ С - Данное испытание имитирует движения скользящей ноги. Оно основано на скольжении мятника по поверхности пола и измеряет коэффициент трения.

Informação Técnica

Technical Information | Information Technique | Technische Information | Техническая Информация | Informazione Tecnica

RESISTÊNCIA AO ESCORREGAMENTO | SLIPPING RESISTANCE | RÉSISTANCE À LA GLISSANCE | RUTSCHFESTIGKEIT | СОПРОТИВЛЕНИЕ СКОЛЬЖЕНИЮ | RESISTENZA ALLO SCIVOLAMENTO

	R9	R10	R11	R12	R13
---	-----------	------------	------------	------------	------------

ANTISCIVOLO
Nelle zone a rischio di scivolamento, l'applicazione di materiale antidrucciolo riduce notevolmente il rischio di scivolamento.
Alcuni degli indicatori utilizzati per misurare il coefficiente di attrito sono:

DIN EN 16165
ALLEGATO B - l'angolo d'inclinazione raggiunto durante la prova di resistenza allo scivolamento. Questa norma determina le caratteristiche antiscivolo dei rivestimenti per pavimento destinati ad essere calpestati a piedi calzati.
ALLEGATO A – norma applicabile a zone bagnate dove il transito si effettua a piedi nudi (zone di piscine, spogliatoi, ecc.)
ALLEGATO C - il test è fatto orizzontalmente dato che è stato concepito per replicare il contatto del piede con il suolo fino al punto in cui può verificarsi lo scivolamento maggiore.

	R9	R10	R11	R12	R13
---	-----------	------------	------------	------------	------------

ANEXO B | ANNEX B

	≥ 6° - 10°	≥ 10° - 19°	≥ 19° - 27°	≥ 27° - 35°	≥ 35°
	R9	R10	R11	R12	R13

**RESISTENTE AO ESCORREGAMENTO
RESISTANT TO SLIPPAGE
RÉSISTANT À LA GLISSANCE
RUTSCHSICHERHEIT
СОПРОТИВЛЕНИЕ СКОЛЬЖЕНИЮ
RESISTENTE ALLO SCIVOLAMENTO**

	A	B	C
--	----------	----------	----------

ANEXO A | ANNEX A

	≥ 12°	≥ 18°	≥ 24°
	A	B	C

**RESISTENTE AO ESCORREGAMENTO
RESISTANT TO SLIPPAGE
RÉSISTANT À LA GLISSANCE
RUTSCHSICHERHEIT
СОПРОТИВЛЕНИЕ СКОЛЬЖЕНИЮ
RESISTENTE ALLO SCIVOLAMENTO**

	A	B	C
---	----------	----------	----------

ANEXO C | ANNEX C

	>36	35 - 25	24 - 0
---	---------------	----------------	---------------

**BAIXO RISCO DE ESCORREGAMENTO
LOW SLIP POTENTIAL
BAS RISQUE DE GLISSANCE
NÖNE RUTSCHGEFAHR
НИЗКИЙ РИСК СКОЛЬЖЕНИЯ
BASSO RISCHIO DI SCIVOLAMENTO**

**ALTO RISCO DE ESCORREGAMENTO
HIGH SLIP POTENTIAL
HAUT RISQUE DE GLISSANCE
GERINGE RUTSCHGEFAHR
ВЫСОКИЙ РИСК СКОЛЬЖЕНИЯ
ALTO RISCHIO DI SCIVOLAMENTO**

Index ▼

Colour Map ▼

Collections ▼

Technical Specifications

Calibers

Certification

General Sales Conditions

Laying Suggestions

Outdoor extra thick

Package









Pr(ect

Symbols









Technical Information

REVESTIMENTOS | WHITE BODY WALL TILES | FAÏENCES MONOCOUISSON | WEISSCHERBIGE | НАСТЕННАЯ | RIVESTIMENTO

NÃO RETIFICADO | NON RECTIFIED | NON RECTIFIÉ | NICHT REKIFIZIERT | НЕРЕКТИФИЦИРОВАННЫЙ | NON RETTIFICATO









FORMATO (CM) SIZE (CM) FORMAT (CM) FORMAT (CM) РАЗМЕР (CM) FORMATO (CM)	ESPESSURA THICKNESS ÉPAISSEUR DICKE ПРОДУКТ SPESSORE	PZ x 	M² x 	KG x 	 x 	M² x 	KG x 	 C A x B x C cm
31 x 62	7,0 mm	8	1,54	18,26 Kg	40	61,50	751 Kg	80 x 120 x 77
20 x 60	8,0 - 10,0 mm Slide Freefall	13	1,56	21,97 Kg	40	62,40	899 Kg	80 x 120 x 95
	9,0 mm	14	1,68	23,24 Kg	40	67,20	950 Kg	80 x 120 x 95
	8,0 mm	15	1,80	24,13 Kg	40	72,00	985 Kg	80 x 120 x 95

RETIFICADO | RECTIFIED | RECTIFIÉ | RECTIFIZIERT | РЕКТИФИЦИРОВАННЫЙ | RETTIFICATO









FORMATO (CM) SIZE (CM) FORMAT (CM) FORMAT (CM) РАЗМЕР (CM) FORMATO (CM)	ESPESSURA THICKNESS ÉPAISSEUR DICKE ПРОДУКТ SPESSORE	PZ x 	M² x 	KG x 	 x 	M² x 	KG x 	 C A x B x C cm
45 x 120	9,5 mm	3	1,62	26,00 kg	21	34,02	566 kg	80 x 125 x 60
	10,1 - 11,4 mm Chess	3	1,62	29,80 kg	18	29,16	557 kg	80 x 125 x 60
	10,0 - 10,4 mm Palm	3	1,62	27,32 kg	21	29,16	512 kg	80 x 125 x 60
	9,5 - 12,0 mm Stellar	3	1,62	27,95 kg	18	29,16	523 kg	80 x 125 x 60
	9,5 - 10,7 mm Desert	3	1,62	27,00 kg	18	29,16	506 kg	80 x 125 x 60
45 x 119	9,0 - 11,9 mm Float	3	1,62	28,27 kg	18	29,16	529 kg	80 x 125 x 60
	9,5 mm	3	1,61	25,20 kg	21	33,81	549 kg	80 x 125 x 60
	9,8 - 11,6 mm Flux	3	1,61	27,76 kg	18	28,97	520 kg	80 x 125 x 60
	8,0 mm	4	1,40	19,35 kg	26	36,40	523 kg	105 x 120 x 50
	10,0 - 10,6 mm Net	3	1,05	19,43 kg	26	27,30	525 kg	105 x 120 x 50
	9,9 - 10,8 mm Leaf	3	1,05	16,91 kg	26	27,30	460 kg	105 x 120 x 50
	9,1-9,9 mm Coastal	3	1,05	17,29 kg	26	27,30	470 kg	105 x 120 x 50
	9,0 - 10,0 mm Wind	3	1,05	17,35 kg	26	27,30	472 kg	105 x 120 x 50
	9,0 - 9,3 mm Flow Precious	3	1,05	17,80 kg	26	27,30	483 kg	105 x 120 x 50
	8,9 - 10,5 mm Shape Precious Marble	3	1,05	17,84 kg	26	27,30	484 kg	105 x 120 x 50
35 x 100	8,8 - 10,5 mm Rise	3	1,05	16,38 kg	26	27,30	446 kg	105 x 120 x 50
	8,8 - 10,1 mm Dune	3	1,05	16,10 kg	26	27,30	439 kg	105 x 120 x 50
	8,7 - 9,9 mm Grain	3	1,05	16,12 kg	26	27,30	439 kg	105 x 120 x 50
	8,5 - 10,0 mm Waterfall	3	1,05	15,68 kg	26	27,30	428 kg	105 x 120 x 50
	8,5 - 9,0 mm Shell	3	1,05	16,01 kg	26	27,30	436 kg	105 x 120 x 50
	8,2 - 9,0 mm Restful	4	1,40	19,57 kg	26	36,40	529 kg	105 x 120 x 50
	7,7 - 8,1 mm Scratch	4	1,40	17,78 kg	26	36,40	482 kg	105 x 120 x 50
	7,6 - 7,8 mm Amazon	4	1,40	17,94 kg	26	36,40	486 kg	105 x 120 x 50
	8,0 mm	6	1,47	19,90 kg	48	70,56	975 kg	105 x 120 x 85
	8,5 - 10,1 mm Match	5	1,23	20,20 kg	48	58,80	990 kg	105 x 120 x 85
35 x 70	7,5 - 8,9 mm Curl	5	1,23	17,10 kg	48	58,80	841 kg	105 x 120 x 85
	7,3 - 8,8 mm Elevation	5	1,23	15,70 kg	48	58,80	773 kg	105 x 120 x 85
	7,2 - 8,7 mm Botanic	6	1,47	19,67 kg	48	70,56	964 kg	105 x 120 x 85
	7,0 mm	8	1,44	18,10 kg	40	57,60	744 kg	80 x 120 x 75
30 x 60	7,5 - 8,5 mm Skin	7	1,26	18,38 kg	40	50,40	755 kg	80 x 120 x 75
	7,2 - 8,5 mm Rise	7	1,26	15,41 kg	40	50,40	637 kg	80 x 120 x 75
	7,1 - 8,5 mm Reef	7	1,26	16,77 kg	40	50,40	690 kg	80 x 125 x 75
	7,0 - 7,3 mm Arid	8	1,44	20,83 kg	40	57,60	853 kg	80 x 125 x 75
	6,9 - 8,1 mm Leaf	7	1,26	15,46 kg	40	50,40	638 kg	80 x 120 x 75

PAVIMENTOS | FLOOR TILES | CARREAUX SOL | BODENFLIESEN | НАПОЛЬНЫЕ ПОКРЫТИЯ | PAVIMENTO







NÃO RETIFICADO | NON RECTIFIED | NON RECTIFIÉ | NICHT REKIFIZIERT | НЕРЕКТИФИЦИРОВАННЫЙ | NON RETTIFICATO

FORMATO (CM) SIZE (CM) FORMAT (CM) FORMAT (CM) РАЗМЕР (CM) FORMATO (CM)	ESPESSURA THICKNESS ÉPAISSEUR DICKE ПРОДУКТ SPESSORE	PZ x 	M² x 	KG x 	 x 	M² x 	KG x 	 C A x B x C cm
61 x 61	8,0 mm	4	1,48	25,53 Kg	36	53,23	940 Kg	80 x 120 x 75,8
60 x 60	20 mm	2	0,72	31,20 Kg	32	23,04	1018 Kg	80 x 120 x 75
45 x 45	8,0 mm	7	1,42	25,90 Kg	34	48,20	901 Kg	80 x 120 x 60
31 x 61	8,0 mm	8	1,50	25,56 Kg	40	59,92	1042 Kg	80 x 120 x 76,6
20 x 100	8,0 mm	7	1,40	25,98 Kg	54	75,60	1423 Kg	105 x 120 x 75
20 x 80	8,0 mm	6	0,96	17,00 Kg	24	23,04	428 Kg	—

RETIFICADO | RECTIFIED | RECTIFIÉ | RECTIFIZIERT | РЕКТИФИЦИРОВАННЫЙ | RETTIFICATO

FORMATO (CM) SIZE (CM) FORMAT (CM) FORMAT (CM) РАЗМЕР (CM) FORMATO (CM)	ESPESSURA THICKNESS ÉPAISSEUR DICKE ПРОДУКТ SPESSORE	PZ x 	M² x 	KG x 	 x 	M² x 	KG x 	 C A x B x C cm
40 x 120	20,0 mm	2	0,96	43,50 kg	24	23,04	1069 kg	86 x 124 x 55
80 x 80	9,0 mm	2	1,28	25,45 kg	42	53,76	1089 kg	85 x 120 x 95
79 x 79	9,0 mm	2	1,25	24,81 kg	42	52,42	1062 kg	85 x 120 x 94
60 x 90	20,0 mm	1	0,54	25,00 kg	40	21,60	1000 kg	94 x 122 x 74
	8,0 mm	2	1,08	19,16 kg	45	48,49	882 kg	94 x 120 x 75
60 x 60	20,0 mm	2	0,71	30,68 kg	32	22,66	1002 kg	80 x 120 x 74,5
	9,0 mm Marble Precious Light	3	1,08	21,10 kg	36	38,75	780 kg	80 x 120 x 74,9
	8,0 mm	4	1,44	24,77 kg	36	51,67	912 kg	80 x 120 x 74,9
30 x 60	8,0 mm	8	1,43	24,40 Kg	40	57,22	996 Kg	80 x 120 x 74,7

RODAPÉ | SKIRTING | PLINTHE | SOCKET | ПЛИТУСА | BATTISCOPA

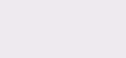
FORMATO (CM) SIZE (CM) FORMAT (CM) FORMAT (CM) РАЗМЕР (CM) FORMATO (CM)	ESPESSURA THICKNESS ÉPAISSEUR DICKE ПРОДУКТ SPESSORE	PZ x 	M² x 	KG x 	 x 	M² x 	KG x 	 C A x B x C cm
8 x 100	8,0 mm	13	—	18,57 Kg	24	—	465,68 Kg	80 x 120 x 50
8 x 90	8,0 mm	12	—	17,20 Kg	30	—	536,00 Kg	80 x 120 x 90
8 x 80	9,0 mm	12	—	17,40 Kg	21	—	385,40 Kg	80 x 120 x 90
8 x 61	8,0 mm	19	—	16,44 Kg	56	—	940,64 Kg	80 x 120 x 72
8 x 60	9 mm Marble Precious Light	17	—	17,82 Kg	56	—	1017,92 Kg	80 x 120 x 72
	8,0 mm	19	—	16,24 Kg	56	—	929,44 Kg	80 x 120 x 72
8 x 45	8,0 mm	31	—	19,24 Kg	49	—	962,76 Kg	80 x 120 x 72

Technical Specifications

Calibers

Certification

General Sales Conditions

Laying Suggestions

Outdoor extra thick

Package

Pr(ect

Symbols

Technical Information

Tabela de Calibres

Calibers | Tableau des calibres | Kaliber | Таблица по калибрам | Tabella Calibri

REVESTIMENTOS | WHITE BODY WALL TILES | FAÏENCES MONOCUISSON | WEISSCHERBIGE | ПЛИТКА ОБЛИЦОВОЧНАЯ ОДНОКРАТНОГО ОБЖИГА | RIVESTIMENTI MONOPOROSA

DIMENSÃO NOMINAL (CM) NOMINAL DIMENSION (CM) DIMENSION Nominale (CM) NENNMASS(CM) РАЗМЕР (CM) DIMENSIONE Nominale (CM)	ESPESSURA THICKNESS ÉPAISSEUR DICKE ПРОДУКТ SPESSORE	C	D	E	H	L
45 x 120 RET.	9,5 mm	-	-	450,0 x 1200,0	-	-
45 x 119 RET.	9,5 mm	-	-	450,0 x 1192,0	-	-
35 x 100 RET.	8,0 mm	-	-	350,0 x 1000,0	-	-
35 x 70 RET.	8,0 mm	-	-	350,0 x 700,0	-	-
31 x 62	7,0 mm	308,6 x 618,0	309,3 x 619,0	310,0 x 620,0	310,7 x 621,0	311,4 x 622,0
30 x 60 RET.	7,0 mm	-	-	300,0 x 600,0	-	-
20 x 60	9,0 mm 8,0 mm	198,6 x 598,0	199,3 x 599,0	200,0 x 600,0	200,7 x 601,0	201,4 x 602,0



PAVIMENTOS | FLOOR TILES | CARREAUX SOL | BODENFLIESEN | НАПОЛЬНЫЕ ПОКРЫТИЯ | PAVIMENTO

DIMENSÃO NOMINAL (CM) NOMINAL DIMENSION (CM) DIMENSION Nominale (CM) NENNMASS(CM) РАЗМЕР (CM) DIMENSIONE Nominale (CM)	ESPESSURA THICKNESS ÉPAISSEUR DICKE ПРОДУКТ SPESSORE	B	C	D	E	H	L	P
80 x 80 RET.	9,0 mm	-	-	-	800,0 x 800,0	-	-	-
79 x 79 RET.	9,0 mm	-	-	-	790,0 x 790,0	-	-	-
61 x 61	8,0 mm	603,5 x 603,5	605,0 x 605,0	606,5 x 606,5	608,0 x 608,0	609,5 x 609,5	611,0 x 611,0	-
60 x 90 RET.	20,0 mm	-	-	-	-	-	-	598,0 x 898,0
	8,0 mm	-	-	-	599,0 x 899,5	-	-	-
60 x 60	20,0 mm	-	597,0 x 597,0	598,5 x 598,5	600,0 x 600,0	601,5 x 601,5	603,0 x 603,0	-
60 x 60 RET.	20,0 mm	595,0 x 595,0	-	-	-	-	-	598,0 x 598,0
	9,0 mm Marble Precious	595,0 x 595,0	-	-	-	-	-	-
	8,0 mm	-	-	-	599,0 x 599,0	-	-	-
45 x 45	8,0 mm	445,8 x 445,8	447,2 x 447,2	448,6 x 448,6	450,0 x 450,0	451,4 x 451,4	452,8 x 452,8	-
40 x 120 RET.	20,0 mm	-	-	-	-	-	-	398,0 x 1198,0
31 x 61	8,0 mm	305,0 x 604,1	306,0 x 605,4	307,0 x 606,7	308,0 x 608,0	309,0 x 609,3	310,0 x 610,6	-
30 x 60 RET.	8,0 mm	-	-	-	298,5 x 599,0	-	-	-
20 x 100	8,0 mm	-	199,2 x 997,4	199,7 x 998,7	200,2 x 1000,0	200,7 x 1001,3	201,2 x 1002,6	-

Simbologia

Symbols | Symbologie | Zeichen | Символика | Simbologia

	Revestimento com acabamento mate Matt wall tiles Faïences en finition mat Wandfliesen - matt oberfläche Настенная керамическая плитка с матовым покрытием Rivestimento con finitura opaca
	Revestimento com acabamento brilho Glossy wall tiles Faïences avec finition brillant Wandfliesen - glänzend oberfläche Настенная керамическая плитка с глянцевым покрытием Rivestimento con finitura lucida
	Revestimento estruturado com acabamento mate Matt structured wall tiles Faïences structurée en finition mat Strukturierte wandfliesen - matt oberfläche Настенная структурированная плитка с матовым покрытием Rivestimento strutturato con finitura opaca
	Revestimento estruturado com acabamento brilho Glossy structured wall tiles Faïences structurée en finition brillant Strukturierte wandfliesen - glänzend oberfläche Настенная структурированная плитка с глянцевым покрытием Rivestimento strutturato con finitura lucida
	Pavimento com acabamento mate Matt floor tiles Carreaux sol en finition mat Bodenfliesen - matt oberfläche Напольная плитка с матовым покрытием Pavimento con finitura opaca
	Pavimento com acabamento polido Floor tiles with polished finish Revêtement de sol avec finition polie Bodenbelag mit polierter oberfläche Полированная поверхность Pavimento con finitura levigata
	Antiderrapante (DIN 51097) Anti-slip (DIN 51097) Antidérapant (DIN 51097) Rutschfest (DIN 51097) Противоскользящий (DIN 51097) Antiscivolo (DIN 51097)
	Antiderrapante (DIN 51130) Anti-slip (DIN 51130) Antidérapant (DIN 51130) Rutsicher (DIN 51130) Противоскользящий (DIN 51130) Antiscivolo (DIN 51130)
	Antiderrapante (BS 7976) Anti-slip (BS 7976) Antidérapant (BS 7976) Rutschfest (BS 7976) Противоскользящий (BS 7976) Antiscivolo (BS 7976)
	Pavimento e revestimento com acabamento mate Matt floor and wall tiles Faïences et carreaux sol en finition mat Wandfliesen und bodenfliesen - matt oberfläche Напольная и настенная плитка с матовым покрытием Pavimento e rivestimento con finitura opaca
	Acabamento brilho Glossy finishing Finition brillant Glanz oberfläche Глянцевое покрытие Finitura lucida
	Produto Antibacteriano Antibacterial product Produit antibactérien Antibakterielle Produkte Антибактериальный продукт Prodotto antibatterico

	Não vidrado Unglazed Non-émailés Unglasiertes Fliesen Неглазурованный Non smaltato
	Espessura Thickness Épaisseur Dicke Толщина Spessore
	Decorações/peças especiais vendidas a m² Decorations/ special pieces sold per m² Décorations/pièces spéciales vendues au m² Dekorationen/sonderposten verkauft pro m² Декорации/специальные изделия продаваемые по м² Decorazioni / pezzi speciali venduti al m²
	40% Desconto adicional 40% Desconto adicional 40% De remise extra 40% Extra-rabatt 40% Дополнительная скидка 40% sconto extra
	Destonização nula Shade variation none Non dénuancé Farbspiel null Различия отсутствуют Stonizzazione nulla
	Destonização ligeira Shade variation slight Légerement dénuancé Farbspiel gering Минимальные различия Stonizzazione leggera
	Destonização baixa Shade variation low Peu dénuancé Farbspiel mittel Небольшие различия Stonizzazione bassa
	Destonização média Shade variation moderate Moynment dénuancé Farbspiel stark Средние различия Stonizzazione media
	Destonização alta Shade Variation high Fortement dénuancé Farbspiel sehr stark Большие различия Stonizzazione alta
	Baixo tráfego Low traffic Faible passage Leicht Frequentiert Движение небольшой интенсивности Traffico leggero
	Médio tráfego Medium traffic Passage modéré Mittlere Frequentierung Движение средней интенсивности Traffico Medio
	Médio alto tráfego Medium high traffic Passage modéré à élevé Mittlere bis starke Frequentierung Интенсивность движения от средней до высокой Traffico Medio Alto

Sugestões de Aplicação

Laying suggestions | Suggestions de pose | Anwendungsvorschläge | Советы по укладке | Suggestimenti di posa



Timber Light Beige
20 x 100

Sugestões de Aplicação

Laying suggestions | Suggestions de pose | Anwendungsvorschläge | Советы по укладке | Suggestimenti di posa

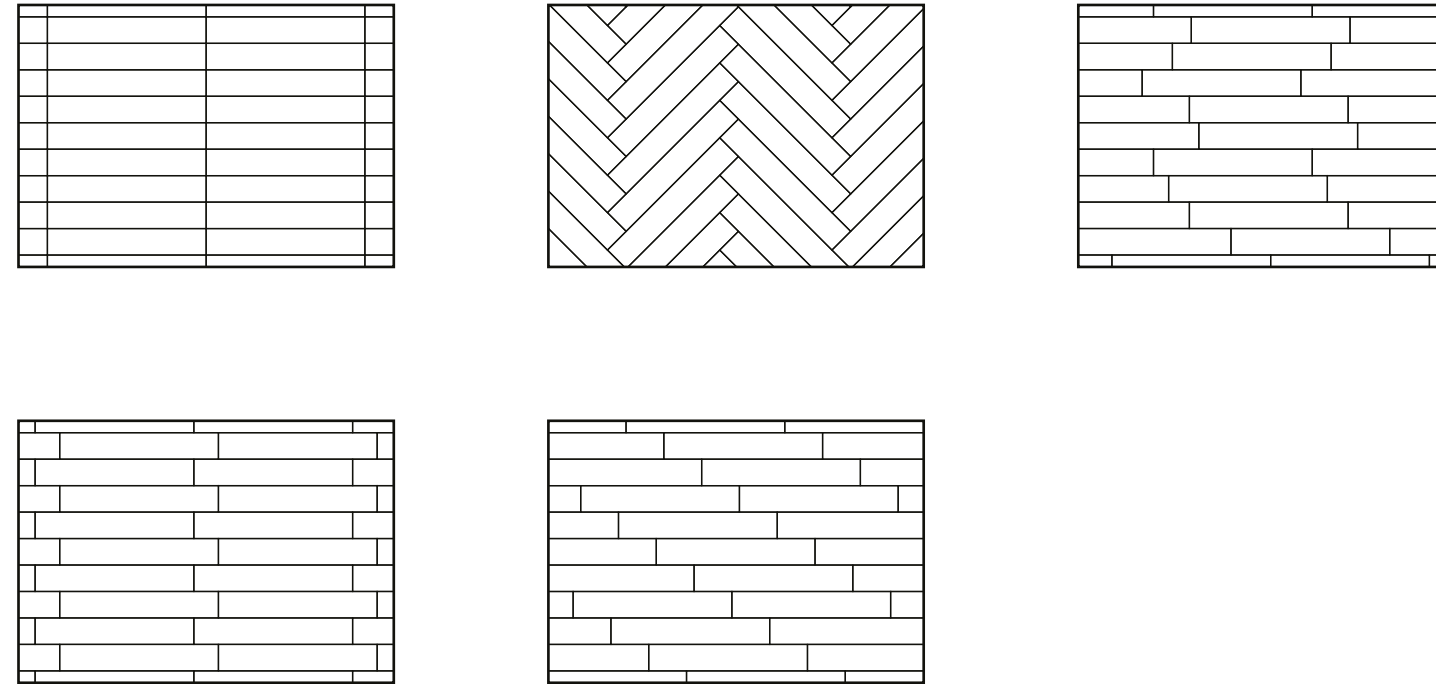

NOT RECOMMENDED | NON RECOMMENDÉ | NICHT EMPFOHLEN | NÃO RECOMENDADO | NICHT EMPFOHLEN | НЕ РЕКОМЕНДУЕТСЯ

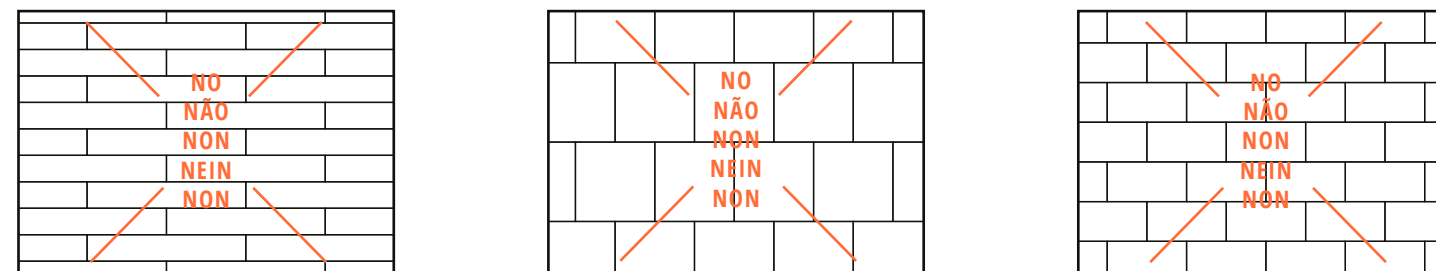

Technical Specifications

Calibers

Certification

General Sales Conditions

Laying Suggestions

Outdoor extra thick

Package

Pr(ect)

Symbols

Technical Information

Condições Gerais de Venda

1 - Aplicabilidade das Condições

1.1. As condições gerais em seguida elencadas e especificadas - de ora em diante denominadas "CONDIÇÕES" -, constituem parte integrante do contrato de compra e venda de mosaicos e outros produtos cerâmicos - de ora em diante designados como o "PRODUTO" ou os "PRODUTOS" - fabricados pela Love Tiles - Gres Panaria Portugal, S.A., também designado como o "FABRICANTE".

1.2. Salvo casos específicos ou excepcionais, em que a aplicação destas condições seja expressamente alterada através de acordo escrito e assinado pelo FABRICANTE, elas representam as condições exclusivas aplicadas a essa venda. Se uma ou mais partes das presentes CONDIÇÕES ou contratos, individualmente considerados e dos quais elas façam parte, forem alguma forma julgadas nulas, inválidas ou inaplicáveis por razões de força maior, as CONDIÇÕES gerais ou particulares permanecerão válidas no seu conjunto, sendo que as condições inválidas serão substituídas por novas disposições que reproduzirão, tanto quanto possível, a intenção original das partes.

2 - Execução do Contrato de Venda - Entrega dos Produtos

2.1. O contrato é celebrado quando a parte proponente ou o comprador tiver conhecimento da aceitação escrita do mesmo pela contraparte.

2.2. Uma encomenda que não tiver sido confirmada por escrito não pode, em nenhuma circunstância, ser considerada como não sido aceite, excepto se tiver sido executada pelo FABRICANTE através do envio ou da entrega dos PRODUTOS. A entrega parcial dos PRODUTOS encomendados não implica a aceitação da totalidade da encomenda, mas apenas da parte dos PRODUTOS que tenham sido efectivamente entregue.

2.3. Excepto se o contrário for prévia e expressamente acordado por escrito, a entrega dos PRODUTOS será efectuada exclusivamente no território de Portugal Continental e na condição de que seja possível e permitido o acesso ao local da entrega de veículo pesado com semi-reboque de 24 (vinte e quatro) toneladas de peso bruto.

2.4. Excepto se o contrário for expressamente acordado por escrito, a entrega dos PRODUTOS apenas será efectuada em obra se a encomenda a entregar for superior a 100m2 (cem metros quadrados).

2.5. Salvo acordo expresso em contrário, todas as datas que forem indicadas para efeitos de entrega, serão consideradas como datas aproximadas.

3 - Características dos Produtos - Garantia - Reclamações

3.1. Os PRODUTOS fabricados pela Love Tiles - Gres Panaria Portugal, S.A. são produzidos em conformidade com as normas europeias aplicáveis. O FABRICANTE vende preferencialmente a revendedores profissionais, sendo estes os responsáveis por prestarem informações técnicas correctas e adequadas aos utilizadores finais ou aos retalhistas.

A classificação dos PRODUTOS é indicada pelo FABRICANTE no material publicitário e/ou nas tabelas de preços. Em consequência, o comprador deverá usar os PRODUTOS em conformidade com as especificações do FABRICANTE.

Para facilitar a sugestão de uso e adaptar a especificação standard à produção específica do FABRICANTE, sobre todos os produtos, listas de preços ou catálogos existem símbolos específicos que indicam a utilização aconselhada para cada produto por parte do FABRICANTE.

3.2. As diferenças de tonalidade ou crominância eventualmente constáveis não decorrem de defeitos do PRODUTO, sendo sim uma característica específica do material cerâmico que foi submetido a czedura a altas temperaturas. A característica especial de "resistência à congelação" apenas se aplica aos produtos que o FABRICANTE tenha especificamente garantido para esse efeito através de uma indicação expressa no seu material publicitário e/ou nas tabelas de preços. No caso de inexistência desta indicação, os produtos serão considerados única e exclusivamente para utilização em interior ou, em qualquer caso, para utilização em locais que não estejam expostos a elementos atmosféricos que alterem as características de resistência ou aparência original do PRODUTO (ex.: precipitação atmosférica, sol, humidade, temperaturas baixas, etc.).

3.3. Os mosaicos com as faces polidas podem alterar o seu aspecto quando utilizados no pavimento de divisões que tenham acesso a partir do exterior, ou divisões onde se preveja intensa circulação pedonal. Os mosaicos polidos podem também ser escorregadios, especialmente quando estiverem molhados ou sob o efeito de humidade. Atento a este motivo o FABRICANTE desaconselha a utilização destes PRODUTOS em locais públicos. Para os locais de circulação intensa de pessoas, o comprador apenas deverá adquirir PRODUTOS classificados pelo FABRICANTE como "PEI V" ou "Grés Porcelânico Toda-à-Massa", em particular os PRODUTOS que o FABRICANTE recomendar especificamente para utilização em locais públicos.

3.4. As apresentações dos PRODUTOS em folhetos ou em qualquer outro material promocional do FABRICANTE são meramente ilustrativos e não representam necessariamente o resultado final estético decorrente da instalação desse produto específico.

3.5. O FABRICANTE garante a boa qualidade e a ausência de defeitos nos PRODUTOS fornecidos.

A garantia não se aplica aos PRODUTOS classificados pelo FABRICANTE como inferiores à qualidade de 1ª escolha, ou aos stocks de produtos que tenham sido descontinuados, quando forem vendidos a granel ou indicados como lote especial.

3.6. O FABRICANTE não é responsável por quaisquer defeitos e/ou anomalias existentes nos PRODUTOS que não derivem das especificações técnicas dos mesmos, mas antes decorram de uma utilização inadequadas dos PRODUTOS por parte dos adquirentes e/ou de terceiros que actuem em seu nome. Em particular, o FABRICANTE não aceita quaisquer reclamações ou litígios ligados às situações anteriormente descritas.

3.7. As reclamações decorrentes da existência de defeitos patentes ou ocultos terão de ser efectuados por escrito ao FABRICANTE pelo comprador no prazo de 60 dias a contar da data de entrega das mercadorias. A responsabilidade do Fabricante por defeitos inerentes aos produtos entregues ao comprador fica expressamente limitado ao prazo de 2 anos a contar da data de recepção do bem pelo comprador.

3.8. Em geral, a garantia apenas se aplica aos defeitos detectados em produtos que ainda não foram aplicados. Relativamente aos defeitos detectados após os PRODUTOS terem sido aplicados, a garantia apenas pode aplicar-se se o FABRICANTE tiver confirmado que a colocação do PRODUTO foi efectuada em conformidade com as melhores regras da actividade (DIN 18352), bem como de acordo com os procedimentos descritos no manual de aplicação e manutenção do FABRICANTE.

3.9. A garantia concedida pelo FABRICANTE limita-se à substituição dos produtos defeituosos por outros produtos do mesmo tipo sem defeito, acrescida das despesas de transporte. É expressamente excluído o reembolso de quaisquer outros custos e/ou despesas e em particular os custos de demolição e recolocação. Em qualquer caso, a garantia do FABRICANTE não pode ultrapassar em cinco vezes o valor do material reclamado, até um valor máximo de 10.000 Euros.

3.10. O FABRICANTE não é responsável por quaisquer reclamações devidas a uma classificação de materiais cerâmicos efectuada por organismos de certificação e controlo e diferentes dos europeus indicados no artigo 3.1, com base em especificações técnicas que não correspondam às indicadas pelo FABRICANTE. Qualquer eventual análise técnica especializada solicitada pelo comprador será baseada na correspondência dos materiais vendidos com as características técnicas indicadas pelo FABRICANTE, nesse momento em vigor em Portugal.

4 - Preços e Condições de Pagamento

4.1 Os preços de venda dos PRODUTOS são os indicados na tabela de preços do FABRICANTE vigente à data de confirmação da encomenda. Para contratos de venda com entregas separadas, o preço será o constante da tabela de preços em vigor à data de cada uma das entregas, excepto se as partes contraentes dispuserem por escrito em sentido diverso.

Para os PRODUTOS destinados a mercados estrangeiros o preço será calculado, por indicação do FABRICANTE, na moeda estrangeira do país de destino ou em Euros.

4.2. Excepto se o contrário for expressamente acordado, os pagamentos serão efectuados através de transferência bancária, no prazo de 30 dias a contar da data da factura. Todas as despesas bancárias e de transferência correm por conta do comprador. No caso de atraso na realização do pagamento o FABRICANTE, juntamente com quaisquer outros prejuízos, terá direito, sem necessidade de aviso prévio ao comprador, a aplicar uma taxa de juros de mora e punitivos equivalente à taxa EURIBOR a 6 meses acrescida de 5%.

5 - Agentes do Fabricante

5.1. Os agentes do FABRICANTE promovem a venda dos PRODUTOS e não estão autorizados a agir em nome e por conta do FABRICANTE, excepto no caso de obterem autorização específica expressa para o efeito.

5.2. As encomendas recebidas pelos agentes não vinculam o FABRICANTE e deverão, portanto, ser expressamente aceites por escrito pelo próprio FABRICANTE.

6 – Reserva de Propriedade

6.1. É acordado entre as partes que a venda dos PRODUTOS seja efectuada com reserva de propriedade por parte do FABRICANTE até que o pagamento integral do preço acordado esteja integralmente saldado por parte do comprador. No entanto, o risco de perda das mercadorias é transferido para o comprador no momento da entrega dos PRODUTOS.

6.2. No caso de vendas para países estrangeiros, quando as mercadorias são vendidas e entregues a terceiros no âmbito das actividades comerciais normais do Comprador e a propriedade das mercadorias ainda não tiver sido transferida, o direito de reserva de propriedade do FABRICANTE permanece válido perante terceiros.

6.3. No caso de atrasos no pagamento o FABRICANTE tem o direito, sem necessidade de recorrer a qualquer formalidade, incluindo qualquer aviso prévio ao comprador, a recolher todas as mercadorias sujeitas a reserva de propriedade e, se legalmente consagrado, todos os títulos de crédito perante terceiros, ficando expressamente reservado o direito do FABRICANTE recorrer a todos os meios legais ao seu dispor tendo em vista o ressarcimento dos prejuízos que tiver sofrido ou que vier a sofrer em consequência da conduta inadimplente do Comprador.

7 – Caso de Força Maior

7.1. O FABRICANTE não será responsável perante o comprador por qualquer incumprimento do contrato, incluindo a falta de entrega ou a entrega com atraso do PRODUTO, causada por factos que estão fora do seu controlo, como por exemplo, a não entrega ou entrega com atraso de materiais por parte de fornecedores, avarias nas instalações, greves, factos da natureza, interrupções no fornecimento de energia eléctrica, suspensão ou dificuldades de transporte.

8 – Legislação Aplicável - Foro Competente

8.1. Na interpretação, integração ou rectificação das presentes condições vigorarão as disposições constantes do Decreto-Lei Nº 67/2003, de 8 de Abril, que não tenham sido afastadas por acordo das partes.

1 - Applicability of Conditions

1.1 The general conditions listed and specified below - hereinafter referred to as the "CONDITIONS" - form an integral part of the contract for the purchase and sale of mosaics and other ceramic products - hereinafter referred to as the "PRODUCT" or the "PRODUCTS" - manufactured by Love Tiles - Gres Panaria Portugal, S.A., also referred to as the "MANUFACTURER".

1.2 Except in specific or exceptional cases, in which the application of these conditions is expressly modified by written agreement and signed by the MANUFACTURER, they represent the exclusive conditions applied to such sale. If one or more parts of these CONDITIONS or contracts, individually considered and of which they form part, are in any way deemed null and void, invalid or unenforceable by reason of force majeure, the general or particular CONDITIONS shall remain valid as a whole and the invalid conditions shall be replaced by new provisions reproducing, as far as possible, the original intention of the parties.

2 - Execution of the Sales Contract - Delivery of Products

2.1. The contract shall be signed when the proposing party or the purchaser becomes aware of its written acceptance by the counterpart.

2.2 An order which has not been confirmed in writing shall under no circumstances be deemed as not having been accepted unless it has been carried out by the MANUFACTURER by sending or delivering the PRODUCTS. The partial delivery of the ordered PRODUCTS does not imply acceptance of the entire order, but only of the part concerning the PRODUCTS that have actually been delivered.

2.3 Unless otherwise expressly agreed in writing and in advance, the delivery of the PRODUCTS shall be made exclusively Ex-works.

2.4 Unless otherwise expressly agreed, all dates indicated for delivery purposes shall be considered as approximate dates.

3 - Product Characteristics - Guarantee - Complaints

3.1. The PRODUCTS manufactured by Love Tiles - Gres Panaria Portugal, S.A. are produced in accordance with the applicable European standards. The MANUFACTURER preferably sells to professional resellers, who are responsible for providing correct and appropriate technical information to end users or retailers.

The classification of the PRODUCTS is indicated by the MANUFACTURER in advertising material and/or price lists. Consequently, the buyer must use the PRODUCTS in accordance with the MANUFACTURER's specifications.

To facilitate the suggestion of use and adapt the standard specification to the specific production of the MANUFACTURER, all products, price lists or catalogues contain specific symbols indicating the recommended use for each product by the MANUFACTURER.

3.2 Differences in tonality or chrominance, if any, do not result from defects in the PRODUCT, rather being a specific characteristic of the ceramic material that has been subjected to firing at high temperatures. The special characteristic of "freezing resistance" only applies to products which the MANUFACTURER has specifically guaranteed for that purpose by means of express indication in its advertising material and/or price lists. In case of absence of this indication , the products will be solely and exclusively considered for indoor use or, in any case, for use in places that are not exposed to atmospheric elements that alter the resistance characteristics or the original look of the PRODUCT (e.g. atmospheric precipitation, sun, humidity, low temperatures, etc.).

3.3 Mosaics with polished faces may change their appearance when used on the floor of rooms that have access from the outside, or rooms where intense pedestrian traffic is expected. Polished tiles can also be slippery, especially when wet or damp. For this reason, the MANUFACTURER advises against the use of these PRODUCTS in public places. For places where people circulate intensively, the buyer should only purchase PRODUCTS classified by the MANUFACTURER as "PEI V" or "Full Body Porcelain Stoneware", in particular those PRODUCTS that the MANUFACTURER specifically recommends for use in public places.

3.4 The presentations of the PRODUCTS in leaflets or in any other promotional material by the MANUFACTURER are merely illustrative and do not necessarily represent the aesthetic end-result arising from the installation of that specific product.

3.5. The MANUFACTURER guarantees the good quality and the absence of defects in the PRODUCTS supplied.

The guarantee does not apply to PRODUCTS classified by the MANUFACTURER as inferior to the 1st. choice quality, or to the stocks of products that have been discontinued, when they are sold in bulk or indicated as special lot.

3.6. The MANUFACTURER shall not be liable for any defects and/or anomalies existing in the PRODUCTS that do not result from their technical specifications but rather arise from the improper use of the PRODUCTS by the purchasers and/or third parties acting on their behalf. In particular, the MANUFACTURER does not accept any complaints or disputes related to the above described situations.

General Sales Conditions

3.7. Complaints arising from the existence of evident or hidden defects must be made to the MANUFACTURER in writing by the purchaser within 60 days from the date of delivery of the goods. The Manufacturer's liability for defects inherent in the products delivered to the Buyer is expressly limited to 2 years from the date of receipt of the goods by the Buyer.

3.8 In general, the guarantee only applies to defects found in products which have not yet been applied. For defects detected after the PRODUCTS have been applied, the guarantee can only apply if the MANUFACTURER has confirmed that the installation of the PRODUCT has been carried out in accordance with the best rules of the activity (DIN 18352), as well as in accordance with the procedures described in the MANUFACTURER's application and maintenance manual.

3.9. The guarantee granted by the MANUFACTURER is limited to the replacement of the defective products with other products of the same type without defect, plus transport costs. The reimbursement of any other costs and/or expenses, in particular demolition and relocation costs, is expressly excluded. In any case, the MANUFACTURER's guarantee does not exceed five times the value of the material claimed, up to a maximum of 10,000 Euros.

3.10. The MANUFACTURER is not responsible for any claims due to a classification of ceramic materials made by certification and control bodies other than the European ones, indicated in article 3.1, based on technical specifications that do not correspond to those indicated by the MANUFACTURER. Any specialised technical analysis requested by the buyer will be based on the correspondence of the materials sold with the technical characteristics indicated by the MANUFACTURER, at that time in force in Portugal.

4 - Prices and Payment Conditions

4.1 The sale prices of the PRODUCTS are those indicated in the MANUFACTURER's price list in force on the date of confirmation of order. For sales contracts with separate deliveries, the price shall be the one set out in the price list in force on the date of each delivery, unless the contracting parties have stipulated differently.

For PRODUCTS aimed at foreign markets the price will be calculated, by indication of the MANUFACTURER, in the foreign currency of the country of destination or in Euros.

4.2 Unless otherwise expressly agreed, payments shall be made by bank transfer within 30 days from the date of invoice. All bank and transfer charges shall be borne by the purchaser. In the event of delay in making payment, the MANUFACTURER, together with any other losses, shall be entitled, without prior notice to the purchaser, to apply a default and punitive interest rate equivalent to the 6-month EURIBOR tax plus 5%.

5 - Manufacturer's Agents

5.1. The MANUFACTURER's agents promote the sale of the PRODUCTS and are not authorised to act in the name and on behalf of the MANUFACTURER, unless they obtain express specific authorisation to do so.

5.2 Orders received by agents are not binding on the MANUFACTURER and must therefore be expressly accepted in writing by the MANUFACTURER itself.

6 – Ownership Reservation

6.1 It is agreed between the parties that the sale of the PRODUCTS shall be made with ownership reservation by the MANUFACTURER until full payment of the agreed price is entirely made by the purchaser. However, the risk of loss of the goods is transferred to the purchaser upon delivery of the PRODUCTS.

6.2 In case of sales to foreign countries, when the goods are sold and delivered to third parties within the framework of the Buyer's normal business activities and the ownership of the goods has not yet been transferred, the MANUFACTURER's ownership reservation remains valid vis-à-vis third parties.

6.3 In the event of delays in payment the MANUFACTURER has the right, without the need for any formality including any prior notice to the purchaser, to collect all goods subject to ownership reservation and if legally enshrined, all credit titles to third parties, and the MANUFACTURER expressly reserves the right to use all legal means at its disposal to recover damages it has suffered or may suffer as a result of defaulting conduct of the purchaser.

7 - Case of Force Majeure

7.1. The MANUFACTURER shall not be liable to the purchaser for any breach of contract, including the non-delivery or late delivery of the PRODUCT, caused by facts beyond its control, such as the non-delivery or late delivery of materials by suppliers, facilities breakdowns, strikes, facts of nature, interruptions in power supply, suspension or transport difficulties.

8 - Applicable Law - Competent Jurisdiction

8.1. In the interpretation, integration or rectification of these conditions, the provisions contained in Decree-Law No. 67/2003 of 8 April 2003 which have not been removed by agreement of the parties, shall apply.

Index ▼

Colour Map ▼

Collections ▼

Technical Specifications

Calibers

Certification

General Sales Conditions

Laying Suggestions

Outdoor extra thick

Package

Pr()tect

Symbols

Technical Information

Conditions Générales de Vente

1 - Conditions applicables

1.1. Les conditions générales, précisées et énumérées ci-après, dénommées les « CONDITIONS », font partie intégrante du contrat de vente de carrelages et autres produits céramiques - ci-après dénommés le « PRODUIT » ou les « PRODUITS » - fabriqués par Love Tiles - Gres Panaria Portugal, S.A., également dénommé le « FABRICANT ».

1.2. Sauf cas particuliers ou exceptionnels, où l'application de ces conditions générales est expressément modifiée par un accord écrit et signé par le FABRICANT, celles-ci représentent les conditions exclusives appliquées à cette vente. Si une ou plusieurs parties de ces CONDITIONS ou contrats, individuellement considérés et dont elles en font partie, sont de quelque manière que ce soit considérées comme nulles, invalides ou inapplicables pour des raisons de force majeure, les CONDITIONS générales ou particulières resteront valables dans leur ensemble, les conditions invalides étant remplacées par de nouvelles dispositions qui reproduiront, autant que possible, l'intention initiale des parties.

2 - Exécution du contrat de vente - Livraison des produits

2.1. Le contrat est conclu lorsque le vendeur ou l'acquéreur prend connaissance de l'acceptation écrite du contrat par l'autre partie.

2.2. Une commande non confirmée par écrit ne pourra en aucun cas être considérée comme non acceptée, sauf lorsqu'elle est exécutée par le FABRICANT via l'envoi ou la livraison des PRODUITS. La livraison partielle des PRODUITS commandés n'implique pas l'acceptation de l'intégralité de la commande, mais uniquement de la partie des PRODUITS effectivement livrée.

2.3. Sauf accord contraire préalable et exprés par écrit, la livraison des PRODUITS sera effectuée exclusivement Ex-works.

2.4. Sauf convention contraire expresse fixée par écrit, toutes les dates indiquées aux fins de la livraison seront considérées comme des dates approximatives.

3 - Caractéristiques des produits - Garantie - Réclamations

3.1. LES PRODUITS fabriqués par Love Tiles - Gres Panaria Portugal, S.A. sont produits conformément aux normes européennes applicables. Le FABRICANT vend de préférence à des revendeurs professionnels, qui sont responsables de fournir des informations techniques correctes et appropriées aux utilisateurs finaux ou aux détaillants.

Le classement des PRODUITS est indiqué par le FABRICANT dans le matériel publicitaire et / ou dans les listes de prix. En conséquence, l'acquéreur doit utiliser les PRODUITS conformément aux spécifications du FABRICANT.

Afin de faciliter la suggestion d'utilisation et d'adapter la spécification standard à la production spécifique du FABRICANT, en ce qui concerne tous les produits, listes de prix ou catalogues, des symboles spécifiques sont ajoutés, indiquant l'utilisation recommandée de chaque produit par le FABRICANT.

3.2. Les différences de tonalité ou de chrominance qui peuvent être constables ne sont pas dues à des défauts du PRODUIT, mais si à une caractéristique spécifique du matériau céramique après avoir été soumis à une cuisson à haute température. La particularité de « résistance au gel » ne s'applique qu'aux produits spécifiquement garantis par le FABRICANT à cet effet, tel qu'indiqué dans son matériel publicitaire et / ou dans les listes de prix. Cette indication n'étant pas présente, les produits sont uniquement et exclusivement conçus pour être utilisés en intérieur ou, dans tous les cas, dans des lieux non exposés à des éléments atmosphériques qui altèrent les caractéristiques de résistance ou l'aspect d'origine du PRODUIT (par exemple : précipitations atmosphériques, soleil, humidité, basses températures, etc.).

3.3. Les carreaux aux faces polies peuvent changer d'apparence lorsqu'elles sont utilisées sur le sol des pièces avec accès à l'extérieur ou des espaces où une circulation piétonne régulière est prévue. Les carreaux polis peuvent également être glissantes, surtout lorsqu'elles sont mouillées ou sous l'effet de l'humidité. Compte tenu de cette caractéristique, le FABRICANT déconseille d'utiliser ces PRODUITS dans les lieux publics. Pour les espaces avec une circulation intense de personnes, l'acquéreur doit acheter exclusivement les PRODUITS classés par le FABRICANT comme « PEI V » ou le « Grès cérame pleine masse », en particulier les PRODUITS que le FABRICANT recommande spécifiquement pour une utilisation dans les espaces publics.

3.4. La présentation des PRODUITS sur des dépliants ou tout autre matériel promotionnel du FABRICANT est purement illustrative et ne représente pas nécessairement le résultat esthétique final de la pose de ce produit spécifique.

3.5. Le FABRICANT garantit la bonne qualité et l'absence de défauts dans les PRODUITS fournis.

La garantie ne s'applique pas aux PRODUITS classés par le FABRICANT comme inférieurs à la qualité de 1er choix, ni aux stocks de produits dont la production est abandonnée, lorsqu'ils sont vendus en vrac ou indiqués comme lot spécial.

3.6. Le FABRICANT n'est pas responsable des défauts et / ou anomalies existant dans les PRODUITS pouvant découler du non-respect des spécifications techniques de ceux-ci, résultant d'une mauvaise utilisation des PRODUITS par les acheteurs et / ou des tiers agissant en leur nom. En particulier, le FABRICANT n'accepte aucune réclamation ou contestation liée aux situations décrites ci-dessus.

3.7. Les réclamations résultant de l'existence de défauts évidents ou cachés doivent être adressées par écrit au FABRICANT par l'acquéreur dans un délai de 60 jours à compter de la date de livraison des marchandises. La responsabilité du fabricant à l'égard des défauts inhérents aux produits livrés à l'acquéreur est expressément limitée à une période de 2 ans à compter de la date de réception des marchandises par l'acquéreur.

3.8. En général, la garantie ne s'applique qu'aux défauts constatés dans les produits qui n'ont pas encore été appliqués. En ce qui concerne les défauts détectés après la pose des PRODUITS, la garantie ne peut s'appliquer que lorsque le FABRICANT confirme que celle-ci a été réalisée conformément aux meilleures règles du métier (DIN 18352) et aux procédures décrites dans le manuel de pose et d'entretien du FABRICANT.

3.9. La garantie accordée par le FABRICANT est limitée au remplacement des produits défectueux par d'autres produits du même type sans défaut, majoré des frais de port. Le remboursement de tous autres frais et / ou dépenses et notamment des frais de démolition et de remplacement est expressément exclu. Dans tous les cas, la garantie du FABRICANT ne peut excéder cinq fois la valeur du matériau réclamé, jusqu'à un montant de 10 000 euros maximum.

3.10. Le FABRICANT ne peut pas être tenu responsable des réclamations dues à tout classement des matériaux céramiques effectué par des organismes de certification et de contrôle différents des organismes européens indiqués à l'article 3.1, sur la base des spécifications techniques qui ne correspondent pas à celles indiquées par le FABRICANT. Toute analyse technique spécialisée éventuelle, demandée par l'acquéreur, sera basée sur la correspondance des matériaux vendus avec les caractéristiques techniques indiquées par le FABRICANT, à présent applicables au Portugal.

4 - Prix et modalités de paiement

4.1 Les prix de vente des PRODUITS sont indiqués dans la liste de prix du FABRICANT, en vigueur à la date de confirmation de la commande. Pour les contrats de vente avec des livraisons séparées, le prix sera celui indiqué dans la liste de prix en vigueur à la date de chaque livraison, sauf si les parties contractantes en ont convenu autrement par écrit.

Pour les PRODUITS destinés aux marchés étrangers, le prix sera calculé, comme indiqué par le FABRICANT, dans la devise étrangère du pays de destination ou en Euros.

4.2. Sauf convention contraire expresse, les paiements seront effectués par virement bancaire, dans les 30 jours suivant la date de facturation. Tous les frais bancaires et de transfert sont à la charge de l'acquéreur. En cas de retard de paiement, le FABRICANT est en droit d'appliquer, sans mise en demeure adressée à l'acquéreur, et outre toutes autres pertes, un taux d'intérêt de retard et punitif équivalent au taux EURIBOR 6 mois majoré de 5%.

5 - Agents du fabricant

5.1. Les agents du FABRICANT doivent promouvoir la vente des PRODUITS, mais ne sont pas autorisés à agir pour le compte du FABRICANT, sauf s'ils obtiennent une autorisation expresse spécifique à cet effet.

5.2. Les commandes reçues par les agents n'engagent pas le FABRICANT. Elles doivent donc être expressément acceptées par écrit par le FABRICANT lui-même.

6 - Réserve de propriété

6.1. Les parties conviennent que la vente des PRODUITS est effectuée sous réserve de propriété par le FABRICANT jusqu'au paiement intégral du prix convenu, par l'acquéreur. Cependant, le risque de perte de la marchandise est transféré à l'acquéreur lors de la livraison des PRODUITS.

6.2. Dans le cas de ventes à l'étranger, lorsque les marchandises sont vendues et livrées à des tiers dans le cadre des activités commerciales normales de l'acquéreur et que le transfert de propriété des marchandises n'a pas encore eu lieu, le droit de réserve de propriété du FABRICANT reste valable à l'égard des tiers.

6.3. En cas de retard de paiement, le FABRICANT a le droit, sans avoir recours à aucune formalité, y compris à toute mise en demeure adressée à l'acquéreur, de retirer toutes les marchandises sous réserve de propriété et, lorsque légalement prévu, tous titres de crédit auprès de tiers. Le FABRICANT est en droit, qui lui est expressément réservé, de recourir à tous les moyens juridiques à sa disposition en vue de compenser les pertes qu'il a subies ou subira du fait du comportement fautif de l'acquéreur.

7 - Force majeure

7.1. Le FABRICANT ne sera pas responsable envers l'acquéreur de toute rupture de contrat, y compris la non-livraison ou la livraison en retard du PRODUIT, causée par des faits indépendants de sa volonté, tels que la non-livraison ou la livraison retardée des matériaux, de la part des fournisseurs, dysfonctionnements des locaux, grèves, faits de la nature, interruptions de l'approvisionnement en électricité, suspension ou difficultés de transport.

8 - Loi applicable - Juridiction compétente

8.1. Les dispositions fixées au décret-loi n° 67/2003, du 8 avril 2003, qui n'aient pas été rejetées par accord entre les parties, s'appliquent dans l'interprétation, l'intégration ou la rectification des présentes conditions.

1 - Anwendbarkeit der Bedingungen

1.1. Die nachstehend aufgeführten und definierten allgemeinen Bedingungen - im Folgenden als "BEDINGUNGEN" bezeichnet - sind integraler Bestandteil des Vertrags für den Kauf und Verkauf von Mosaikfliesen und anderen keramischen Produkten - im Folgenden als "PRODUKT" oder "PRODUKTE" bezeichnet - hergestellt von Love Tiles - Gres Panaria Portugal, S.A., auch als "HERSTELLER" bezeichnet.

1.2. Außer in besonderen oder außergewöhnlichen Fällen, in denen die Anwendung dieser Bedingungen ausdrücklich durch eine schriftliche Vereinbarung geändert und vom HERSTELLER unterzeichnet wurden, stellen sie die ausschließlichen Bedingungen dar, die in Verbindung mit einem solchen Verkauf geltend gemacht werden können. Wenn ein oder mehrere Teile dieser BEDINGUNGEN oder Verträge einzeln betrachtet werden und Bestandteil dieser sind, aufgrund höherer Gewalt in irgendeiner Weise als nichtig, ungültig oder nicht durchsetzbar gelten, bleiben die allgemeinen oder besonderen BEDINGUNGEN als Ganzes gültig. Die ungültigen Bedingungen werden durch neue Bestimmungen ersetzt, die so weit wie möglich die ursprüngliche Absicht der Parteien wiedergeben.

2 - Ausführung des Kaufvertrags - Lieferung von Produkten

2.1. Der Vertrag ist abgeschlossen, wenn der vorschlagenden Partei oder dem Käufer die schriftliche Annahme durch die Gegenpartei bekannt ist.

2.2. Eine Bestellung, die nicht schriftlich bestätigt wurde, kann unter keinen Umständen als nicht angenommen betrachtet werden, es sei denn, sie wurde vom HERSTELLER durch Versand oder Lieferung der PRODUKTE ausgeführt. Die Teillieferung der bestellten PRODUKTE bedeutet nicht die Annahme der gesamten Bestellung, sondern nur des Teils der PRODUKTE, der tatsächlich geliefert worden ist.

2.3. Sofern nicht ausdrücklich schriftlich und im Voraus anders vereinbart, erfolgt die Lieferung der PRODUKTE ausschließlich ab Werk.

2.4. Sofern nicht ausdrücklich anders vereinbart, gelten alle für Lieferzwecke angegebenen Daten als ungefähre Daten.

3 - Eigenschaften der Produkte - Garantie - Reklamationen

3.1. Die von Love Tiles - Gres Panaria Portugal, S.A. hergestellten PRODUKTE werden in Übereinstimmung mit den geltenden europäischen Normen hergestellt. Der HERSTELLER verkauft vorzugsweise an professionelle Wiederverkäufer. Diese sind für die Bereitstellung korrekter und angemessener technischer Informationen für Endbenutzer oder Einzelhändler verantwortlich.

Die Klassifizierung der PRODUKTE wird vom HERSTELLER auf Werbematerial und/oder Preislisten angegeben. Folglich muss der Käufer die PRODUKTE in Übereinstimmung mit den Spezifikationen des HERSTELLERS verwenden.

Um den Verwendungsvorschlag zu erleichtern und die Standardspezifikation an die spezifische Produktion des HERSTELLERS anzupassen, sind auf allen Produkten, Preislisten oder Katalogen spezifische Symbole angebracht, die die vom HERSTELLER empfohlene Verwendung für jedes Produkt angeben.

3.2. Die Unterschiede in Tonalität oder Farbe , wenn überhaupt, sind nicht auf Fehler im PRODUKT zurückzuführen, sondern eine spezifische Eigenschaft des keramischen Materials, das bei hohen Temperaturen gebrannt wurde. Die besondere Eigenschaft der "Frostbeständigkeit" gilt nur für Produkte, für die der HERSTELLER ausdrücklich in seinen Werbematerialien und/oder in den Preislisten diese Garantie gibt. Fehlt diese Angabe, werden die Produkte nur und ausschließlich für die Verwendung in Innenräumen oder jedenfalls für die Verwendung an Orten betrachtet, die nicht atmosphärischen Elementen ausgesetzt sind, die die Haltbarkeitseigenschaften oder das ursprüngliche Aussehen des PRODUKTES verändern (z. B. atmosphärischer Niederschlag, Sonne, Feuchtigkeit, niedrige Temperaturen, etc.).

3.3. Die Fliesen mit den polierten Oberflächen können ihr Aussehen verändern, wenn sie als Bodenbelag in Räumen verwendet werden, die von außen zugänglich sind, oder in Räumen, in denen intensiver Fußgängerverkehr erwartet wird. Polierte Fliesen können auch rutschig sein, insbesondere wenn sie nass oder feucht sind. Aus diesem Grund rät der HERSTELLER davon ab, diese PRODUKTE an öffentlichen Orten zu verwenden. Für Orte, an denen intensiver Fußgängerverkehr zu erwarten ist, sollte der Käufer nur PRODUKTE kaufen, die vom HERSTELLER als "PEI V" oder "Vollmassiges Feinsteinzeug" klassifiziert werden, insbesondere solche PRODUKTE, die der HERSTELLER speziell für die Verwendung an öffentlichen Orten empfiehlt.

3.4. Die Präsentationen der PRODUKTE in Broschüren oder in anderem Werbematerial des HERSTELLERS dienen lediglich der Veranschaulichung und stellen nicht unbedingt das ästhetische Endergebnis dar, das sich aus der Installation dieses spezifischen Produkts ergibt.

3.5. Der HERSTELLER garantiert die gute Qualität und die Mängelfreiheit der gelieferten PRODUKTE.

Die Garantie gilt nicht für PRODUKTE, die vom HERSTELLER als minderwertig gegenüber der Qualität der 1. Wahl eingestuft werden, oder für die Lagerbestände von Produkten, die eingestellt wurden, wenn sie lose verkauft oder als Sonderposten angegeben werden.

3.6. Der HERSTELLER haftet nicht für Mängel und/oder Anomalien der PRODUKTE, die sich nicht aus den technischen Spezifikationen derselben ableiten, sondern aus der unangemäßen Verwendung der PRODUKTE durch die Käufer und/oder in ihrem Namen handelnde Dritte entstehen. Insbesondere akzeptiert der HERSTELLER keine Beschwerden oder Streitigkeiten im Zusammenhang mit den oben beschriebenen Situationen.

Allgemeine Verkaufsbedingungen

1.1. Les conditions générales, précisées et énumérées ci-après, dénommées les « CONDITIONS », font partie intégrante du contrat de vente de carrelages et autres produits céramiques - ci-après dénommés le « PRODUIT » ou les « PRODUITS » - fabriqués par Love Tiles - Gres Panaria Portugal, S.A., également dénommé le « FABRICANT ».

1.2. Sauf cas particuliers ou exceptionnels, où l'application de ces conditions générales est expressément modifiée par un accord écrit et signé par le FABRICANT, celles-ci représentent les conditions exclusives appliquées à cette vente. Si une ou plusieurs parties de ces CONDITIONS ou contrats, individuellement considérés et dont elles en font partie, sont de quelque manière que ce soit considérées comme nulles, invalides ou inapplicables pour des raisons de force majeure, les CONDITIONS générales ou particulières resteront valables dans leur ensemble, les conditions invalides étant remplacées par de nouvelles dispositions qui reproduiront, autant que possible, l'intention initiale des parties.

1.3. Les réclamations résultant de l'existence de défauts évidents ou cachés doivent être adressées par écrit au FABRICANT par l'acquéreur dans un délai de 60 jours à compter de la date de livraison des marchandises. La responsabilité du fabricant à l'égard des défauts inhérents aux produits livrés à l'acquéreur est expressément limitée à une période de 2 ans à compter de la date de réception des marchandises par l'acquéreur.

1.4. En général, la garantie ne s'applique qu'aux défauts constatés dans les produits qui n'ont pas encore été appliqués. En ce qui concerne les défauts détectés après la pose des PRODUITS, la garantie ne peut s'appliquer que lorsque le FABRICANT confirme que celle-ci a été réalisée conformément aux meilleures règles du métier (DIN 18352) et aux procédures décrites dans le manuel de pose et d'entretien du FABRICANT.

1.5. La garantie accordée par le FABRICANT est limitée au remplacement des produits défectueux par d'autres produits du même type sans défaut, majoré des frais de port. Le remboursement de tous autres frais et / ou dépenses et notamment des frais de démolition et de remplacement est expressément exclu. Dans tous les cas, la garantie du FABRICANT ne peut excéder cinq fois la valeur du matériau réclamé, jusqu'à un montant de 10 000 euros maximum.

1.6. Le FABRICANT ne peut pas être tenu responsable des réclamations dues à tout classement des matériaux céramiques effectué par des organismes de certification et de contrôle différents des organismes européens indiqués à l'article 3.1, sur la base des spécifications techniques qui ne correspondent pas à celles indiquées par le FABRICANT. Toute analyse technique spécialisée éventuelle, demandée par l'acquéreur, sera basée sur la correspondance des matériaux vendus avec les caractéristiques techniques indiquées par le FABRICANT, à présent applicables au Portugal.

1.7. Les prix de vente des PRODUITS sont indiqués dans la liste de prix du FABRICANT, en vigueur à la date de confirmation de la commande. Pour les contrats de vente avec des livraisons séparées, le prix sera celui indiqué dans la liste de prix en vigueur à la date de chaque livraison, sauf si les parties contractantes en ont convenu autrement par écrit.

1.8. Pour les PRODUITS destinés aux marchés étrangers, le prix sera calculé, comme indiqué par le FABRICANT, dans la devise étrangère du pays de destination ou en Euros.

1.9. Sauf convention contraire expresse, les paiements seront effectués par virement bancaire, dans les 30 jours suivant la date de facturation. Tous les frais bancaires et de transfert sont à la charge de l'acquéreur. En cas de retard de paiement, le FABRICANT est en droit d'appliquer, sans mise en demeure adressée à l'acquéreur, et outre toutes autres pertes, un taux d'intérêt de retard et punitif équivalent au taux EURIBOR 6 mois majoré de 5%.

4 - Preise und Zahlungsbedingungen

4.1. Die Verkaufspreise der PRODUKTE sind diejenigen, die in der am Datum der Auftragsbestätigung gültigen Preisliste des HERSTELLERS angegeben sind. Bei Kaufverträgen mit getrennten Lieferungen gilt der Preis, der in der am Tag der jeweiligen Lieferung gültigen Preisliste angegeben ist, sofern die Vertragsparteien nichts anderes schriftlich vereinbart haben.

Für PRODUKTE, die für ausländische Märkte bestimmt sind, wird der Preis nach Angaben des HERSTELLERS in der Fremdwährung des Bestimmungslandes oder in Euro berechnet.

4.2. Sofern nicht ausdrücklich anders vereinbart, sind Zahlungen per Banküberweisung innerhalb von 30 Tagen ab Rechnungsdatum zu leisten. Alle Bank- und Überweisungsgebühren gehen zu Lasten des Käufers. Bei Zahlungsverzug ist der HERSTELLER berechtigt, zusammen mit allen anderen Verlusten und ohne vorherige Benachrichtigung des Käufers, einen Verzugs- und Strafzinssatz in Höhe des EURIBOR sechs Monate plus 5% anzuwenden.

5 - Vertreter des Herstellers

5.1. Die Vertreter des HERSTELLERS werben für den Verkauf der PRODUKTE und sind nicht befugt, im Namen und im Auftrag des HERSTELLERS zu handeln, es sei denn, sie erhalten dafür eine ausdrückliche Sondergenehmigung.

5.2. Aufträge, die von Vertretern entgegengenommen werden, sind für den HERSTELLER nicht bindend und müssen daher vom HERSTELLER selbst ausdrücklich und schriftlich angenommen werden.

6 – Eigentumsvorbehalt

6.1. Es wird zwischen den Parteien vereinbart, dass der Verkauf der PRODUKTE unter Eigentumsvorbehalt seitens des HERSTELLERS erfolgt, bis der Käufer den vereinbarten Preis vollständig bezahlt hat. Das Verlustrisiko der Waren geht jedoch mit der Lieferung der PRODUKTE auf den Käufer über.

6.2. Im Falle von Verkäufen ins Ausland bleibt der Eigentumsvorbehalt des HERSTELLERS gegenüber dem Dritten bestehen, wenn die Waren im Rahmen der normalen Geschäftstätigkeit des Käufers an einen Dritten verkauft und geliefert werden und das Eigentumsrecht an den Waren noch nicht übertragen wurde.

6.3. Bei Zahlungsverzug hat der HERSTELLER das Recht, ohne jegliche Formalität, einschließlich irgendwelcher vorherigen Benachrichtigung des Käufers, alle unter Eigentumsvorbehalt stehenden Waren und, falls gesetzlich erlaubt, alle Kredittitel vor Dritten einzuziehen, wobei dem HERSTELLER ausdrücklich das Recht vorbehalten bleibt, alle ihm zur Verfügung stehenden rechtlichen Mittel einzusetzen, um den Schaden, den er aufgrund des säumigen Verhaltens des Käufers erlitten hat oder erleiden wird, wieder gutzumachen.

7 – Fall von höherer Gewalt

7.1. Der HERSTELLER haftet dem Käufer gegenüber nicht für Vertragsverletzungen, einschließlich der Nichtlieferung oder verspäteten Lieferung des PRODUKTES, die durch Tatsachen verursacht werden, die sich seiner Kontrolle entziehen, wie z.B. Nichtlieferung oder verspätete Lieferung von Materialien durch Lieferanten, Betriebsstörungen, Streiks, Naturkatastrophen, Unterbrechungen der Stromversorgung, Aussetzung oder Transportschwierigkeiten.

8 – Anwendbares Recht - Zuständiges Gericht

8.1. Bei der Auslegung, Umsetzung oder Berichtigung dieser Bedingungen gelten die im Gesetzesdekret Nr. 67/2003 vom 8. April 2003 enthaltenen Bestimmungen, wenn sie nicht durch Vereinbarung der Parteien aufgehoben wurden.

Index ▾

Colour Map ▾

Collections ▾

Technical Specifications

Calibers

Certification

General Sales Conditions

Laying Suggestions

Outdoor extra thick

Package

Pr()tect

Symbols

Technical Information

Основные условия продаж

1 – Применимость условий

1.1. Перечисленные и указанные ниже общие условия, в дальнейшем именуемые «УСЛОВИЯ», составляют неотъемлемую часть договора купли-продажи мозаики и других керамических изделий, именуемых в дальнейшем «ПРОДУКТ» или «ПРОДУКЦИЯ», производства Love Tiles - Gres Panaria Portugal, S.A., также известного как “ПРОИЗВОДИТЕЛЬ”.

1.2. За исключением особых или исключительных случаев, когда применение этих условий конкретно изменяется посредством письменного соглашения, составленного и подписанного ПРОИЗВОДИТЕЛЕМ, они представляют собой исключительные условия, применяемые к данной продаже. Если одна или несколько частей настоящих УСЛОВИЙ или договоров, рассматриваемых индивидуально и являющихся неотъемлемой их частью, каким-либо образом считается недействительной или неприемимой по причинам форс-мажора, общие или частные УСЛОВИЯ, в целом, будут оставаться в силе, а недействительные условия будут заменены новыми положениями, которые будут максимально воспроизводить первоначальные намерения сторон.

2 – Оформление договора купли-продажи – Доставка товара

2.1. Контракт считается заключенным, когда предлагающая сторона или покупатель узнает о письменном принятии контракта контрагентом.

2.2. Заказ, не подтвержденный в письменной форме, ни при каких обстоятельствах не может считаться принятым, если он не был выполнен ПРОИЗВОДИТЕЛЕМ путем отправки или доставки ПРОДУКЦИИ. Частичная доставка заказанных ТОВАРОВ не подразумевает принятие всего заказа, а только той части ТОВАРОВ, которая была фактически доставлена.

2.3. За исключением случаев, когда иное явно оговорено в письменной форме, доставка ПРОДУКЦИИ будет производиться исключительно на условиях Ex-works (франко-завод).

2.4. Если прямо не согласовано иное, все даты, указанные для целей доставки, будут рассматриваться как приблизительные.

3 – Характеристика продукции - Гарантия - Претензии

3.1. ПРОДУКЦИЯ, производимая Love Tiles - Gres Panaria Portugal, S.A., производится в соответствии с действующими европейскими стандартами. ПРОИЗВОДИТЕЛЬ предпочитает продавать свою продукцию профессиональным посредникам, которые несут ответственность за предоставление правильной и соответствующей технической информации конечным пользователям, или продавцам розничной торговли. Классификация ТОВАРОВ указывается ПРОИЗВОДИТЕЛЕМ в рекламных материалах и/или в прайс-листах. Следовательно, покупатель должен применять ТОВАР в соответствии со спецификациями ПРОИЗВОДИТЕЛЯ.

Для облегчения предложения по использованию и адаптации стандартной спецификации к конкретной продукции ПРОИЗВОДИТЕЛЯ, на всех продуктах, прайс-листах или каталогах есть специальные символы, указывающие на рекомендуемое ПРОИЗВОДИТЕЛЕМ использование для каждого продукта.

3.2. Различия в тональности или в ценности, которые могут оставаться неизменными, не связаны с дефектами ИЗДЕЛИЯ, а являются специфической характеристикой керамического материала, который был подвергнут высокотемпературному обжигу. Особенность «морозостойкости» применима только к продукции, которую ПРОИЗВОДИТЕЛЬ гарантировал специально для этой цели, посредством прямого указания в своих рекламных материалах и/или в прайс-листах. При отсутствии этого указания продукты будут рассматриваться исключительно для использования внутри помещений или, в любом случае, для использования в местах, которые не подвергаются воздействию атмосферных элементов, которые изменяют характеристики сопротивления или первоначальный внешний вид ПРОДУКТА (например: атмосферные осадки, солнце, влажность, низкие температуры и др.).

3.3. Мозаика с полированными поверхностями может изменить свой внешний вид при использовании на полу в помещениях, имеющих доступ снаружи, или в помещениях, где предполагается интенсивное движение пешеходов. Полированная мозаика также может быть скользкой, особенно когда она влажная или находится под воздействием влаги. По этой причине, ПРОИЗВОДИТЕЛЬ не рекомендует использовать эту ПРОДУКЦИЮ в общественных местах. Для пространств с интенсивным движением людей покупатель должен приобретать только ПРОДУКЦИЮ, классифицированную ПРОИЗВОДИТЕЛЕМ, как "PEI V" или "универсальный Керамогранит", в частности ту ПРОДУКЦИЮ, которую ПРОИЗВОДИТЕЛЬ рекомендует использовать в общественных местах.

3.4. Представление ПРОДУКЦИИ в брошюрах или в любых других рекламных материалах ПРОИЗВОДИТЕЛЯ носит исключительно иллюстративный характер и не обязательно отражает конечный эстетический результат установки этого конкретного продукта.

3.5. ПРОИЗВОДИТЕЛЬ гарантирует хорошее качество и отсутствие брака поставляемой ПРОДУКЦИИ. Гарантия не распространяется на ТОВАРЫ, классифицированные ПРОИЗВОДИТЕЛЕМ, как худшие по качеству, по 1-му выбору, или на те запасы продукции, которые были сняты с производства, когда они продаются оптом или указаны как специальные партии.

3.6. ПРОИЗВОДИТЕЛЬ не несет ответственности за любые дефекты и/или аномалии, обнаруженные в ПРОДУКЦИИ, которые не являются следствием технических характеристик этих материалов, а являются результатом неправильного использования ПРОДУКЦИИ покупателями и/или третьими лицами, действующими от их имени. В частности, ПРОИЗВОДИТЕЛЬ не принимает никаких претензий или споров, связанных с ситуациями, описанными выше.

3.7. Претензии, связанные с наличием патентных или скрытых дефектов, должны быть предъявлены покупателем в письменной форме в адрес ПРОИЗВОДИТЕЛЯ в течение 60 дней с даты доставки товара. Ответственность ПРОИЗВОДИТЕЛЯ за дефекты, присущие товарам, доставленных покупателю, конкретно ограничена сроком в 2 года с даты получения товара покупателем.

3.8. Как правило, гарантия распространяется только на дефекты, обнаруженные в продукции, которая еще не была применена. В отношении дефектов, обнаруженных после применения ПРОДУКТОВ, гарантия действует только в том случае, если ПРОИЗВОДИТЕЛЬ подтвердил, что применение ПРОДУКТА было выполнено в соответствии с лучшими правилами деятельности (DIN 18352), а также в соответствии с процедурами, описанными ПРОИЗВОДИТЕЛЕМ в руководстве по применению и эксплуатации.

3.9. Гарантия, предоставляемая ПРОИЗВОДИТЕЛЕМ, ограничивается заменой дефектных продуктов на другие продукты того же типа, без дефектов, включая стоимость доставки. Возмещение любых других затрат и/или расходов и, в частности, затрат на снос и замену, категорически исключается. В любом случае, гарантия ПРОИЗВОДИТЕЛЯ не может превысить пятикратную стоимость востребованного продукта, до максимальной стоимости 10.000 евро.

3.10. ПРОИЗВОДИТЕЛЬ не несет ответственности за какие-либо претензии в связи с классификацией керамических материалов, проводимой органами сертификации и контроля, отличной от европейской, указанной в статье 3.1, на основании технических характеристик, не соответствующих указанным ПРОИЗВОДИТЕЛЕМ. Любой, возможный специализированный технический анализ, запрошенный покупателем, будет основан на соответствии продаваемых материалов техническим характеристикам, указанных ПРОИЗВОДИТЕЛЕМ, действующих, в настоящее время, в Португалии.

4 – Цены и условия оплаты

4.1 Продажные цены на ПРОДУКТЫ указаны в прейскуранте ПРОИЗВОДИТЕЛЯ, действующем на день подтверждения заказа. Для договоров купли-продажи с отдельными поставками стоимость будет соответствовать цене, указанной в прейскуранте, действующем на дату каждой поставки, если договаривающиеся стороны не указали иное направление.

Для ТОВАРОВ, предназначенных для зарубежных рынков, цена будет рассчитываться, по указанию ПРОИЗВОДИТЕЛЯ, в иностранной валюте страны назначения или в евро.

4.2. За исключением случаев, когда прямо оговорено иное, платежи будут производиться банковским переводом в течение 30 дней с даты выставления счета. Все банковские сборы и комиссии за перевод оплачивает покупатель. В случае задержки платежа ПРОИЗВОДИТЕЛЬ, совместно с любыми другими убытками, будет иметь право без предварительного уведомления покупателя, применить штрафную процентную ставку, эквивалентную 6-месячной ставке EURIBOR плюс 5%.

5 - Представители производителя

5.1. Агенты ПРОИЗВОДИТЕЛЯ способны продать ПРОДУКТОВ и не имеют права действовать от имени ПРОИЗВОДИТЕЛЯ, если только они не получают для этой цели специальное прямое разрешение.

5.2. Заказы, полученные агентами фирмы, не являясь обязательными для ПРОИЗВОДИТЕЛЯ и поэтому должны быть письменно подтверждены самим ПРОИЗВОДИТЕЛЕМ.

6 – Право собственности

6.1. Между сторонами согласовано, что продажа ПРОДУКЦИИ осуществляется с правом собственности со стороны ПРОИЗВОДИТЕЛЯ до полной оплаты покупателем по согласованной цене. Однако риск потери товара переходит к покупателю при доставке ТОВАРА.

6.2. В случае продаж за границу, когда товары продаются и доставляются третьими лицами в рамках обычной коммерческой деятельности Покупателя и право собственности на товары еще не передано, право собственности ПРОИЗВОДИТЕЛЯ остается в силе с третьими сторонами.

6.3. В случае просрочки платежа, ПРОИЗВОДИТЕЛЬ имеет право, без необходимости прибегать к каким-либо формальностям, включая какое-либо предварительное уведомление покупателю, получить обратно все товары, подлежащие сохранению его праву собственности, и, если это законодательно закреплено, - все кредитные документы перед третьими лицами, сохраняя за собой право ПРОИЗВОДИТЕЛЯ, защищенное законом и имеющихся в распоряжении правовых средств, с целью компенсации понесенных убытков или возможных убытков, возникших в результате неисполнения обязательств Покупателем.

7 – Форс-мажорная ситуация

7.1. ПРОИЗВОДИТЕЛЬ не несет ответственности перед покупателем за любое нарушение контракта, включая непоставку или задержку доставки ТОВАРА, вызванные фактами, которые находятся вне его контроля, например, недоставкой или задержкой доставки материалов от поставщиков, поломки оборудования, забастовок, стихийных бедствий, перебоев в подаче электроэнергии, приостановки или транспортных затруднений.

8 – Применимое законодательство – Компетентный Трибунал

8.1. При толковании, интеграции или исправлении данных условий применяются положения, содержащиеся в Декрете-Законе № 67/2003, от 8 апреля, которые не были отменены соглашением сторон.

1 - Applicabilità delle condizioni

1.1. Le condizioni generali ivi riportate e specificate - di seguito denominate “CONDIZIONI” - formano parte integrante del contratto di compravendita di piastrelle e altri prodotti ceramici - di seguito denominati “PRODOTT0” o “PRODOTTI” - realizzati da Love Tiles - Gres Panaria Portugal, S.A., denominata anche “PRODUTTORE”.

1.2. Salvo casi specifici o eccezionali, in cui l'applicazione di queste condizioni è espressamente modificata per accordo scritto e firmato dal PRODUTTORE, esse rappresentano le condizioni esclusive applicate a tale vendita. Se una o più parti delle presenti CONDIZIONI o dei contratti, considerate singolarmente e di cui fanno parte, dovessero risultare in qualche modo nulle, invalide o inapplicabili per cause di forza maggiore, le CONDIZIONI generali o particolari rimarranno valide nella loro interezza e le condizioni invalide saranno sostituite da nuove disposizioni che riproducano, per quanto possibile, l'intenzione originaria delle parti.

2 - Esecuzione del contratto di vendita - Consegna dei prodotti

2.1. Il contratto è concluso quando la parte offerente o l'acquirente è a conoscenza dell'accettazione scritta della controparte.

2.2. Un ordine che non sia stato confermato per iscritto non può in nessun caso essere considerato come non accettato, a meno che non sia stato eseguito dal PRODUTTORE inviando o consegnando i PRODOTTI. La consegna parziale dei PRODOTTI ordinati non implica l'accettazione dell'intero ordine, ma solo della parte dei PRODOTTI effettivamente consegnati.

2.3. Se non diversamente ed espressamente concordato per iscritto in anticipo, la consegna dei PRODOTTI avverrà esclusivamente Ex-works.

2.4. Se non espressamente concordato diversamente, tutte le date indicate per la consegna sono da considerarsi date approssimative.

3 - Caratteristiche dei prodotti - Garanzia - Reclami

3.1. I PRODOTTI realizzati da Love Tiles - Gres Panaria Portugal, S.A. sono realizzati in conformità alle norme europee applicabili. Il PRODUTTORE vende preferibilmente a rivenditori professionali, che hanno la responsabilità di fornire informazioni tecniche corrette e appropriate agli utenti finali o ai rivenditori.

La classificazione dei PRODOTTI è indicata dal PRODUTTORE nel materiale pubblicitario e/o nei listini prezzi. Di conseguenza, l'acquirente utilizzerà i PRODOTTI in conformità alle specifiche del PRODUTTORE.

Per facilitare il suggerimento d'uso e adattare la specifica standard alla specifica produzione del PRODUTTORE, su tutti i prodotti, listini prezzi o cataloghi sono presenti simboli specifici che indicano l'uso consigliato per ogni prodotto dal PRODUTTORE.

3.2. Eventuali differenze di tonalità o cromaticanza non sono dovute a difetti del PRODOTTO, ma sono una caratteristica specifica del materiale ceramico che è stato sottoposto a cottura ad alte temperature. La particolare caratteristica della “resistenza al congelamento” si applica solo ai prodotti che il PRODUTTORE ha espressamente garantito a tale scopo mediante un'espressa indicazione nel suo materiale pubblicitario e/o nei listini prezzi. In assenza di tale indicazione, i prodotti saranno considerati solo ed esclusivamente per uso interno o, comunque, per uso in luoghi non esposti ad elementi atmosferici che alterino le caratteristiche di resistenza o l'aspetto originale del PRODOTTO (ad es. precipitazioni atmosferiche, sole, umidità, basse temperature, ecc.)

3.3. Le piastrelle lucide possono cambiare il loro aspetto se utilizzate sul pavimento di ambienti che hanno accesso dall'esterno, o di ambienti soggetti a calpestio intenso. Le piastrelle lucide possono anche essere scivolose, soprattutto se bagnate o umide. Per questo motivo, il PRODUTTORE sconsiglia l'utilizzo di questi PRODOTTI in luoghi pubblici. Per gli ambienti soggetti a calpestio intenso, l'acquirente deve acquistare solo PRODOTTI classificati dal PRODUTTORE come “PEI V” o “Gres Porcellanato a Tutta Massa”, in particolare quei PRODOTTI che il PRODUTTORE raccomanda specificamente per l'uso in luoghi pubblici.

3.4. Le presentazioni dei PRODOTTI nelle brochure o in qualsiasi altro materiale promozionale del PRODUTTORE sono puramente illustrative e non rappresentano necessariamente il risultato estetico finale risultante dalla posa di questo specifico prodotto.

3.5. Il PRODUTTORE garantisce la buona qualità e l'assenza di difetti nei PRODOTTI forniti.

La garanzia non si applica ai PRODOTTI classificati dal PRODUTTORE come inferiori alla qualità di prima scelta, né alle scorte di prodotti fuori produzione, se venduti sfusi o indicati come lotti speciali.

3.6. Il PRODUTTORE non sarà responsabile di eventuali difetti e/o anomalie dei PRODOTTI che non derivino dalle specifiche tecniche dei PRODOTTI, ma che derivino piuttosto dall'uso improprio dei PRODOTTI da parte degli acquirenti e/o di terzi che agiscono per loro conto. In particolare, il PRODUTTORE non accetta reclami o controverse relative alle situazioni sopra descritte.

3.7. Le richieste di risarcimento per vizi di brevetto o per vizi occulti devono essere presentate per iscritto dall'acquirente al PRODUTTORE entro 60 giorni dalla data di consegna della merce. La responsabilità del produttore per i difetti inerenti alla merce consegnata al cliente è espressamente limitata a 2 anni dalla data di ricevimento della merce da parte del cliente.

Condizioni Generali di Vendita

3.8. In generale, la garanzia è valida solo per i difetti riscontrati sui prodotti che non sono ancora stati applicati. Per i difetti rilevati dopo l'applicazione del PRODOTTO, la garanzia può essere applicata solo se il PRODUTTORE ha confermato che la posa del PRODOTTO è stata eseguita a regola d'arte (DIN 18352), oltre che secondo le procedure descritte nel manuale di posa e manutenzione del PRODUTTORE.

3.9. La garanzia concessa dal PRODUTTORE è limitata alla sostituzione dei prodotti difettosi con altri prodotti dello stesso tipo senza difetti, più le spese di trasporto. È espressamente escluso il rimborso di eventuali altri costi e/o spese, in particolare le spese di demolizione e di trasloco. In ogni caso, la garanzia del PRODUTTORE non può superare il quintuplo del valore del materiale richiesto, fino ad un massimo di 10.000 euro.

3.10. Il PRODUTTORE non è responsabile di eventuali reclami dovuti ad una classificazione dei materiali ceramici effettuata da enti di certificazione e controllo diversi da quelli europei di cui all'art. 3.1 sulla base di specifiche tecniche che non corrispondono a quelle indicate dal PRODUTTORE. Qualsiasi analisi tecnica specialistica richiesta dall'acquirente si baserà sulla corrispondenza dei materiali venduti con le caratteristiche tecniche indicate dal PRODUTTORE, all'epoca in vigore in Portogallo.

4 - Prezzi e condizioni di pagamento

4.1 I prezzi di vendita dei PRODOTTI sono quelli indicati nel listino prezzi del PRODUTTORE in vigore alla data della conferma d'ordine. Per i contratti di vendita con consegne separate, il prezzo è quello indicato nel listino prezzi in vigore alla data di ciascuna delle consegne, a meno che le parti contraenti non abbiano scritto diversamente.

Per i PRODOTTI destinati ai mercati esteri il prezzo sarà calcolato, con indicazione del PRODUTTORE, nella valuta estera del paese di destinazione o in euro.

4.2 Se non espressamente concordato diversamente, i pagamenti devono essere effettuati tramite bonifico bancario entro 30 giorni dalla data della fattura. Tutte le spese bancarie e di bonifico sono a carico dell'Acquirente. In caso di ritardo nel pagamento, il FORNITORE, insieme a qualsiasi altra perdita, avrà il diritto, senza preavviso all'acquirente, di applicare un tasso di interesse di mora e punitivo pari all'EURIBOR a 6 mesi più il 5%.

5 – Agenti del Produttore

5.1. Gli agenti del PRODUTTORE promuovono la vendita dei PRODOTTI e non sono autorizzati ad agire in nome e per conto del PRODUTTORE, a meno che non ottengano un'espressa autorizzazione specifica in tal senso.

5.2. Gli ordini ricevuti dagli agenti non sono vincolanti per il PRODUTTORE e devono quindi essere espressamente accettati per iscritto dal PRODUTTORE stesso.

6 - Prenotazione di immobili

6.1. Le parti concordano che la vendita dei PRODOTTI verrà effettuata con riserva di proprietà da parte del PRODUTTORE fino al completo pagamento del prezzo concordato da parte dell'Acquirente. Tuttavia, il rischio di perdita della merce viene trasferito all'acquirente al momento della consegna dei PRODOTTI.

6.2. Nel caso di vendite all'estero, quando la merce viene venduta e consegnata a terzi nel normale corso della normale attività commerciale dell'Acquirente e la proprietà della merce non è ancora stata trasferita, la riserva di proprietà del PRODUTTORE rimane valida nei confronti del terzo.

6.3. In caso di ritardo nei pagamenti, il PRODUTTORE ha il diritto, senza alcuna formalità, compreso qualsiasi preavviso all'acquirente, di ritirare tutti i beni soggetti a riserva di proprietà e, se previsto dalla legge, tutti i titoli di credito di fronte a terzi, essendosi espressamente riservato il diritto del PRODUTTORE di utilizzare tutti i mezzi legali a sua disposizione al fine di recuperare i danni che ha subito o subirà a causa del comportamento inadempiente dell'acquirente.

7 - Caso di forza maggiore

7.1. Il PRODUTTORE non sarà responsabile nei confronti dell'acquirente per qualsiasi violazione del contratto, inclusa la mancata o ritardata consegna del PRODOTTO, causata da fatti al di fuori del suo controllo, come la mancata o ritardata consegna dei materiali da parte dei fornitori, guasti agli impianti, scioperi, forze della natura, interruzioni dell'alimentazione elettrica, sospensione o difficoltà di trasporto.

8 - Legge applicabile - Foro competente

8.1. Per l'interpretazione, l'integrazione o la rettifica delle presenti condizioni, valgono le disposizioni contenute nel D.L. 8 aprile 2003, n. 67/2003, che non siano state rimosse di comune accordo tra le parti.

Index ▾

Colour Map ▾

Collections ▾

Technical Specifications

Calibers

Certification

General Sales Conditions

Laying Suggestions

Outdoor extra thick

Package

Pr()tect

Symbols

Technical Information

Condiciones Generales de Venta

1 - Aplicabilidad de las Condiciones

1.1. Las condiciones generales enumeradas y especificadas a continuación –en adelante denominadas “CONDICIONES” -, constituyen parte integrante del contrato de compraventa de baldosas y de otros productos cerámicos – en adelante designados como el “PRODUCTO” o los “PRODUCTOS” o los “PRODUCTOS” - fabricados por Love Tiles - Gres Panaria Portugal, S.A., también designado como el “FABRICANTE”.

1.2. Salvo casos específicos o excepcionales, en los que la aplicación de estas condiciones sea expresamente alterada a través de un acuerdo por escrito y firmado por el FABRICANTE, las mismas representan las condiciones exclusivas aplicadas a esta venta. Si una o más partes de las presentes CONDICIONES o contratos, individualmente considerados y de los cuales formen parte, fuesen consideradas nulas, inválidas o inaplicables, por razones de fuerza mayor, las CONDICIONES generales o particulares permanecerán válidas en su conjunto, sustituyéndose las condiciones inválidas por nuevas disposiciones que reproducirán, lo mejor posible, la intención original de las partes.

2 – Ejecución del Contrato de Venta - Entrega de los Productos

2.1. El contrato se celebra cuando la parte proponente o el comprador tenga conocimiento de la aceptación escrita del mismo por la contraparte.

2.2. Un pedido que no haya sido confirmado por escrito no puede ser considerado, bajo ninguna circunstancia, como no habiendo sido aceptado, excepto cuando haya sido ejecutado por el FABRICANTE, a través del envío o de la entrega de los PRODUCTOS. La entrega parcial de los PRODUCTOS del pedido no implica la aceptación de la totalidad del pedido, sino tan solo la parte de los PRODUCTOS que efectivamente han sido entregados.

2.3. Excepto cuando, previa y expresamente se haya acordado lo contrario, por escrito, la entrega de los PRODUCTOS se efectuará exclusivamente Exwoks.

2.4. Salvo acuerdo expreso en contrario, todas las fechas que se indiquen a efectos de entrega serán consideradas como fechas aproximadas.

3 - Características de los Productos - Garantía - Reclamaciones

3.1. Los PRODUCTOS fabricados por Love Tiles - Gres Panaria Portugal, S.A. se elaboran de acuerdo con las normas europeas aplicables. El FABRICANTE vende, de preferencia, a revendedores profesionales, que son responsables de prestar las informaciones técnicas correctas y adecuadas a los utilizadores finales o a los minoristas.

El FABRICANTE indicará la clasificación de los PRODUCTOS en el material publicitario y/o en las listas de precios. Así, el comprador deberá usar los PRODUCTOS conforme las especificaciones del FABRICANTE.

Para facilitar la sugerencia de utilización y adaptar la especificación estándar a la producción específica del FABRICANTE, existen, en todos los productos, listas de precios o catálogos, símbolos específicos que indican la utilización aconsejada para cada producto, por parte del FABRICANTE.

3.2. Las diferencias de tonalidad o crominancia que eventualmente puedan constar, no se deben a defectos del PRODUCTO, sino que es una característica específica del material cerámico que ha sido sometido a cocción, a altas temperaturas. La característica especial de “resistencia a la congelación” apenas se aplica a los productos garantizados como tales por el FABRICANTE, a través de una indicación expresada en su material publicitario y/o en las listas de precios. Cuando no exista esta indicación, los productos serán considerados única y exclusivamente para utilización en interior o, en cualquier caso, para ser utilizados en lugares que no se encuentren expuestos a los elementos atmosféricos que puedan alterar las características de resistencia o apariencia original del PRODUCTO (ej.: precipitación atmosférica, sol, humedad, bajas temperaturas, etc.).

3.3. Las baldosas de caras pulidas pueden sufrir alteraciones de aspecto cuando se utilicen como pavimento de estancias cuyo acceso se realice a partir del exterior, o estancias en las que se prevea una intensa circulación peatonal. Las baldosas pulidas también pueden resultar escurridizas, especialmente cuando están mojadas o por efecto de la humedad. Considerando este último aspecto, el FABRICANTE no recomienda utilizar estos PRODUCTOS en locales públicos. Para aquellos lugares con una circulación intensa de personas, el comprador apenas deberá adquirir PRODUCTOS clasificados por el FABRICANTE como “PEIV” o “Gres Porcelánico Todo Masa”, en particular los PRODUCTOS recomendados por el FABRICANTE específicamente para ser utilizados en lugares públicos.

3.4. Las presentaciones de los PRODUCTOS en folletos o en cualquier otro material promocional del FABRICANTE son meramente ilustrativos y, no tienen por qué representar el resultado final estético tras la instalación de ese producto específico.

3.5. El FABRICANTE garantiza la buena calidad y la ausencia de defectos en los PRODUCTOS suministrados.

La garantía no se aplica a los PRODUCTOS clasificados por el FABRICANTE como inferiores a los de 1ra calidad, o a los stocks de productos discontinuados, cuando se vendan a granel o estén indicados como lote especial.

3.6. El FABRICANTE no se responsabiliza por cualquier defectos y/o anomalías existentes en los PRODUCTOS que no resulten de las especificaciones técnicas de los mismos, sino que se deban a un uso inadecuado de los PRODUCTOS por parte de los adquirentes y/o de terceros que actúen en su nombre. En concreto, el FABRICANTE no acepta ninguna reclamación o litigio relacionada con las situaciones anteriormente descritas.

3.7. Las reclamaciones resultantes de la existencia de defectos patentes u ocultos tendrán que ser efectuadas por el comprador, por escrito, dirigidas al FABRICANTE, en un plazo de 60 días a partir de la fecha de entrega de las mercancías. La responsabilidad del Fabricante por defectos inherentes a los productos entregados al comprador queda expresamente limitada al plazo de 2 años a partir de la fecha de recepción de los bienes por parte del comprador.

3.8. En general, la garantía apenas se aplica a los defectos detectados en productos que aún no han sido aplicados. En relación a los defectos detectados tras la aplicación de los PRODUCTOS, la garantía apenas se podrá aplicar si el FABRICANTE hubiera confirmado que la instalación del PRODUCTO fue realizada de acuerdo con las mejores reglas de la actividad (DIN 18352), así como conforme a los procedimientos descritos en el manual de aplicación y mantenimiento del FABRICANTE.

3.9. La garantía concedida por el FABRICANTE se limita a la sustitución de los productos defectuosos por otros productos del mismo tipo, sin defecto, más gastos de transporte. Queda expresamente excluido el reembolso de cualquier otros costes y/o gastos, y en particular los costes con demoliciones y reinstalaciones. De cualquier manera, la garantía del FABRICANTE no podrá superar cinco veces el valor del material reclamado, hasta un valor máximo de 10.000 Euros.

3.10. El FABRICANTE no se responsabiliza de ninguna reclamación causada por una clasificación de materiales cerámicos efectuada por organismos de certificación y control diferentes de los europeos, indicados en el artículo 3.1, con base en especificaciones técnicas que no correspondan a las indicadas por el FABRICANTE. Cualquier eventual análisis técnico especializado, solicitado por el comprador se basará en la correspondencia de los materiales vendidos con las características técnicas indicadas por el FABRICANTE, vigentes en Portugal en ese momento.

4 – Precios y condiciones de pago

4.1 Los precios de venta de los PRODUCTOS están indicados en la lista de precios del FABRICANTE, vigente en la fecha de confirmación del pedido. Para contratos de venta con entregas separadas, el precio será el que conste en la lista de precios en vigor en la fecha de cada una de las entregas, excepto cuando las partes contratantes dispongan, por escrito, lo contrario.

Para los PRODUCTOS destinados a mercados extranjeros, el precio se calculará, por indicación del FABRICANTE, en la moneda extranjera del país de destino o en euros.

4.2. Excepto cuando se acuerde expresamente lo contrario, los pagos se efectuarán a través de transferencia bancaria, en un plazo de 30 días a partir de la fecha de la factura. Todos los gastos bancarios y de transferencias correrán por cuenta del comprador. En caso de atraso en la realización del pago, el FABRICANTE, además de cualquier otros perjuicios, sin necesidad de aviso previo al comprador, tendrá derecho a aplicar un tipo de interés de demora y punitivos equivalente al EURIBOR a 6 meses, más un 5%.

5 - Agentes del Fabricante

5.1. Los agentes del FABRICANTE promueven la venta de los PRODUCTOS y no están autorizados a actuar en nombre y por cuenta del FABRICANTE, excepto cuando obtengan autorización específica expresa al efecto.

5.2. Los pedidos recibidos por los agentes no vinculan al FABRICANTE y, por lo tanto, deberán ser expresamente aceptados, por escrito, por el propio FABRICANTE.

6 – Reserva de Propiedad

6.1. Se acuerda entre las partes que la venta de los PRODUCTOS se efectuará con reserva de propiedad por parte del FABRICANTE, hasta que el pago integral del precio acordado haya sido completamente saldado por parte del comprador. No obstante, el riesgo de pérdida de las mercancías será transferido al comprador en el acto de la entrega de los PRODUCTOS.

6.2. En caso de ventas a países extranjeros, cuando las mercancías son vendidas y entregadas a terceros, en el ámbito de las actividades comerciales normales del Comprador y la propiedad de las mismas aún no haya sido transferida, el derecho de reserva de propiedad del FABRICANTE permanece válido ante terceros.

6.3. En caso de atraso en el pago, el FABRICANTE, sin necesidad de recurrir a cualquier formalidad, incluyendo cualquier aviso previo al comprador, tiene derecho a recoger todas las mercancías sujetas a reserva de propiedad y, si estuviera legalmente consagrado, todos los títulos de crédito ante terceros, quedando reservado expresamente el derecho del FABRICANTE de recurrir a todos los medios legales a su disposición para resarcirse de los perjuicios que haya sufrido o que llegue a sufrir como consecuencia de la conducta incumplidora del Comprador.

7 – Caso de fuerza mayor

7.1. El FABRICANTE no se responsabilizará, ante el comprador, por cualquier incumplimiento del contrato, incluyendo la falta de entrega o la entrega con atraso del PRODUCTO, causada por situaciones que no están bajo su control, como por ejemplo, la no entrega o entrega con atraso de materiales por parte de proveedores, averías en las instalaciones, huelgas, fenómenos de la naturaleza, interrupciones en el suministro de la energía eléctrica, suspensión o dificultad en el transporte.

8 – Legislación aplicable - Fuero competente

8.1. Para la interpretación, integración o rectificación de las presentes condiciones estarán vigentes las disposiciones constantes en el Decreto Ley N.º 677/2003, de 8 de abril, que no hayan sido rechazadas por acuerdo de las partes.

GRES PANARIA

Portugal S.A.

© COPYRIGHT GRES PANARIA PORTUGAL S.A.

© 2015

© 2015

© 2015

© 2015

© 2015

© 2015

© 2015

© 2015

© 2015

© 2015

© 2015

© 2015

© 2015

© 2015

© 2015

© 2015

© 2015

© 2015

© 2015

© 2015

© 2015

© 2015

© 2015

© 2015

© 2015

© 2015

© 2015

© 2015

© 2015

© 2015

© 2015

© 2015

© 2015

© 2015

© 2015

© 2015

© 2015

© 2015

© 2015

© 2015

© 2015

© 2015

© 2015

© 2015

© 2015

© 2015

© 2015

© 2015

© 2015

© 2015

© 2015

© 2015

DIE GRÖSSENANGABEN DER IN DIESER BROSCHÜRE ABGEBILDETEN PRODUKTE SIND NENNGRÖSSEN, WESHALB SIE DIE GENAUEN GRÖSSEN

BITTE BEI LOVE TILES ANFRAGEN.

ALLE ANGABEN IN DIESER BROSCHÜRE HABEN LEDIGLICH INFORMATIVEN CHARAKTER UND ENTSPRECHEN KEINER VERTRAGLICHEN ZUSICHERUNG.

LOVE TILES BEHÄLT SICH DAS RECHT VOR, DIE INHALTE DIESER BROSCHÜRE JEDERZEIT OHNE VORHERIGE ANKÜNDIGUNG ZU ÄNDERN.

DIE IN DIESER BROSCHÜRE ABGEBILDETEN FARBEN DIENEN NUR ZUR ORIENTIERUNG UND KÖNNEN ERHEBLICH VARIIEREN.

STETS DARAUf BEDACHT, AUF DIE BEDÜRFNISSE IHRER KUNDEN EINZUGEHEN, ERNEUERT LOVE TILES HÄUFIG IHR PRODUKTSORTIMENT,

WESHALB NICHT ALLE IN DIESER BROSCHÜRE ENTHALTENEN PRODUKTE UNBEDINGT ZERTIFIZIERT SIND.

DIE IN DIESEM KATALOG GENANNTEN ODER DARGESTELLTEN PRODUKTE UND MARKEN SIND EIGENTUM DER GRES PANARIA PORTUGAL S.A.. DIE MARKEN, DESIGNS, ZEICHNUNGEN, FOTOGRAFIEEN UND TEXTE SIND GESETZLICH GESCHÜTZT. KOMPLETTE ODER TEILWEISE KOPIEN, NACHAHMUNGEN, ÄNDERUNGEN IRGENDNEINES KONSTITUTIVEN ODER REPRÄSENTATIVEN ELEMENTS DER MARKEN, NAMENTLICH WÖRTER, SYMBOLE, FARBEN ODER ANDERER ELEMENTE, SOWIE LOGOS, ZEICHNUNGEN, DESIGNS, LAYOUTS VON KATALOGEN, DESIGN-AMBIENTEN ODER IN DIESEN DARGESTELLTEN DEKORATIONEN SIND OHNE SCHRIFTLICHE GENEHMIGUNG DER GRES PANARIA PORTUGAL S.A. AUSDRÜCKLICH VERBOTEN. DIE VERLETZUNG IRGENDNEINER IN DIESER ERKLÄRUNG ANGEGEBENEN BESTIMMUNGEN KANN ZU EINER ZIVIL- UND STRAFRECHTLICHEN VERFOLGUNG DES VERLETZENDEN FÜHREN.

© 2015

© 2015

© 2015

© 2015

© 2015

© 2015

© 2015

© 2015

© 2015

© 2015

© 2015

© 2015

© 2015

© 2015

© 2015

© 2015

© 2015

© 2015

© 2015

© 2015

© 2015

© 2015

© 2015

© 2015

© 2015

© 2015

© 2015

© 2015

© 2015

© 2015

© 2015

© 2015

© 2015

© 2015

© 2015

© 2015

© 2015

© 2015

© 2015

© 2015

© 2015

© 2015

© 2015

© 2015

© 2015

© 2015

© 2015

Index

Colour Map

Collections

Technical Specifications

Calibers

Certification

General Sales Conditions

Laying Suggestions

Outdoor extra thick

Package

Pr(otect

Symbols

Technical Information



Zona Industrial de Aveiro
Apartado 3002
3801-101 AVEIRO . PORTUGAL

lovetiles@lovetiles.com
www.lovetiles.com



APICER

associação portuguesa das indústrias
de cerâmica e cristalaria



N.º 2000/CEP.1049
N.º 2005/AMB.0244

COORDENAÇÃO:
Marketing Love Ceramic Tiles

DESIGN E PRODUÇÃO:
Viriato & Viriato, janeiro 2023

[Index](#) ▼

[Colour Map](#) ▼

[Collections](#) ▼

[Technical Specifications](#) ▼

LOVE
CERAMIC TILES