

2023

**MARGRES**  
CERAMIC TILES



[index](#)



[colour map](#)



[collections](#)



[linea collections](#)



[useful information](#)



**MARGRES**  
CERAMIC TILES

2023



# 20 YEARS OF STYLE

## 20 years of Margres

When we created the Margres brand in 2003, a persevering and visionary international group, the Panaria Group, had the mission to become a leader in the ceramics sector in Portugal. The goal was to solidify, grow and maximize the value of a company that since 1982, generation after generation, has built a legacy in the ceramic sector that would pass on to others and endure until today.

As we celebrate Margres' twentieth anniversary, our mission remains unchanged. Above all, this milestone is a celebration of our clients, the people and companies with whom we have established partnerships over the last two decades and, of course, those who, day after day, work in a company with heritage and history: our employees.

Over the last two decades we have grown significantly, bringing our strong industrial expertise to customers both nationally and globally. Our products are changing, towards more sustainable and environmentally friendly ceramics and this is one of our major goals until 2030.

Staying close to our customers has always been and will continue to be a priority for us. Above all, we want to use this milestone year as an opportunity to thank our customers and partners for the trust they have placed in us. We are humbled by this and look forward to continuing to grow together over the coming years.

These first 20 years are just the beginning of something great.

## 20 Jahre Margres

Als wir im Jahr 2003 die Marke Margres gegründet haben, hatte eine beharrliche und visionäre internationale Gruppe, die Panaria-Gruppe, die Aufgabe, ein führendes Unternehmen in der Keramikbranche in Portugal zu werden. Ziel war es, den Wert eines Unternehmens das seit 1982, Generation für Generation, ein Vermächtnis im Keramiksektor aufgebaut hat, zu festigen, zu steigern und zu maximieren, ein Erbe das an andere Personen weitergegeben wurde und bis heute Bestand hat.

Während wir das zwanzigjährige Jubiläum von Margres feiern, bleibt unsere Mission unverändert. Dieser Meilenstein ist vor allem eine Feier unserer Kunden, der Menschen und Unternehmen, mit denen wir in den letzten zwei Jahrzehnten Partnerschaften aufgebaut haben, und natürlich derer, die Tag für Tag in einem Unternehmen mit Tradition und Geschichte arbeiten: unsere Mitarbeiter.

In den vergangenen zwei Jahrzehnten sind wir erheblich gewachsen und haben unser starkes industrielles Fachwissen Kunden im In- und Ausland zur Verfügung gestellt. Unsere Produkte verändern sich hin zu nachhaltiger und umweltfreundlicher Keramik, und dies ist eines unserer wichtigsten Ziele bis 2030.

Die Nähe zu unseren Kunden war immer und wird weiterhin für uns eine Priorität. Vor allem aber wollen wir dieses wegweisende Jubiläumsjahr zum Anlass nehmen, uns bei unseren Kunden und Partnern für das entgegengebrachte Vertrauen zu bedanken. Wir fühlen uns dadurch tief geehrt und freuen uns darauf, in den kommenden Jahren gemeinsam weiter zu wachsen.

Diese ersten 20 Jahre sind erst der Anfang von etwas Großartigem.

## 20 ans de Margres

Lorsque nous avons créé la marque Margres en 2003, un groupe international persévérant et visionnaire, le groupe Panaria, avait pour mission de devenir un leader du secteur de la céramique au Portugal. L'objectif était de solidifier, de développer et de maximiser la valeur d'une entreprise qui, depuis 1982, génération après génération, a construit un héritage dans le secteur de la céramique qui se transmettrait aux autres et perdurerait jusqu'à nos jours.

Alors que nous célébrons le vingtième anniversaire de Margres, notre mission reste inchangée. Cette étape est avant tout une célébration de nos clients, des personnes et des entreprises avec lesquelles nous avons établi des partenariats au cours des deux dernières décennies et, bien sûr, de ceux qui, jour après jour, travaillent dans une entreprise avec un héritage et une histoire : nos employés.

Au cours des deux dernières décennies, nous avons connu une croissance significative, apportant notre solide expertise industrielle à nos clients tant au niveau national qu'international. Nos produits évoluent vers des céramiques plus durables et respectueuses de l'environnement, et c'est l'un de nos principaux objectifs d'ici 2030.

Rester proche de nos clients a toujours été et restera une priorité pour nous. Nous souhaitons avant tout profiter de cette année charnière pour remercier nos clients et partenaires de la confiance qu'ils nous accordent. Nous en sommes humblement reconnaissants et nous nous réjouissons de continuer à grandir ensemble au cours des années à venir.

Ces 20 premières années ne sont que le début de quelque chose de superbe.

## 20 anos de Margres

Quando criámos a marca Margres em 2003, um grupo internacional perseverante e visionário, o Panaria Group, tinha a missão de se tornar líder no setor cerâmico em Portugal. O objetivo era solidificar, crescer e maximizar o valor de uma empresa que desde 1982, geração após geração, construiu um legado no setor cerâmico que passaria para outras pessoas e perduraria até hoje.

Ao celebrarmos o vigésimo aniversário da Margres, a nossa missão permanece inalterada. Acima de tudo, este marco é uma celebração dos nossos clientes, das pessoas e empresas com quem estabelecemos parcerias ao longo das últimas duas décadas e, claro, quem dia após dia, trabalha numa empresa com herança e história: os nossos colaboradores.

Ao longo das últimas duas décadas, crescemos significativamente, trazendo a nossa forte perícia industrial a clientes tanto a nível nacional como mundial. Os nossos produtos estão a mudar, rumo a uma cerâmica mais sustentável e amiga do ambiente e esse é um dos nossos grandes objetivos até 2030.

Permanecer perto dos nossos clientes sempre foi e continuará a ser uma prioridade para nós. Acima de tudo, queremos usar este ano marcante como uma oportunidade para agradecer aos nossos clientes e parceiros pela confiança que depositaram em nós. Estamos humildemente agradecidos por isso e esperamos continuar a crescer juntos durante os próximos anos.

Estes primeiros 20 anos são apenas o começo de algo grandioso.

**MARGRES**  
CERAMIC TILES



# index

— index . index . índice

## collections

concept	P. 105
edge	P. 117
endless	P. 027
evoke	P. 071
extreme	P. 219
grove	P. 131
hybrid	P. 059
jungle	P. 083
natural	P. 187
prestige	P. 093
pure stone	P. 039
slabstone	P. 171
subway	P. 191
tecnica	P. 225
time 2.0	P. 201
tool	P. 145
underground	P. 159

## linea collections

cosmos	P. 273
endless	P. 235
magnetic	P. 263
prestige	P. 285
pure stone	P. 255
slabstone	P. 295
subway	P. 305
time 2.0	P. 315
tool	P. 277

## useful information

calibers	P. 356
certification	P. 330
general sales conditions	P. 360
important notes	P. 367
margres green	P. 328
laying suggestions	P. 359
outdoor extra thick	P. 338
package	P. 354
pr()tect	P. 324
symbols	P. 358
technical information	P. 342
think zero	P. 326

# sizes' index

— index formats . index formate . índice formatos —

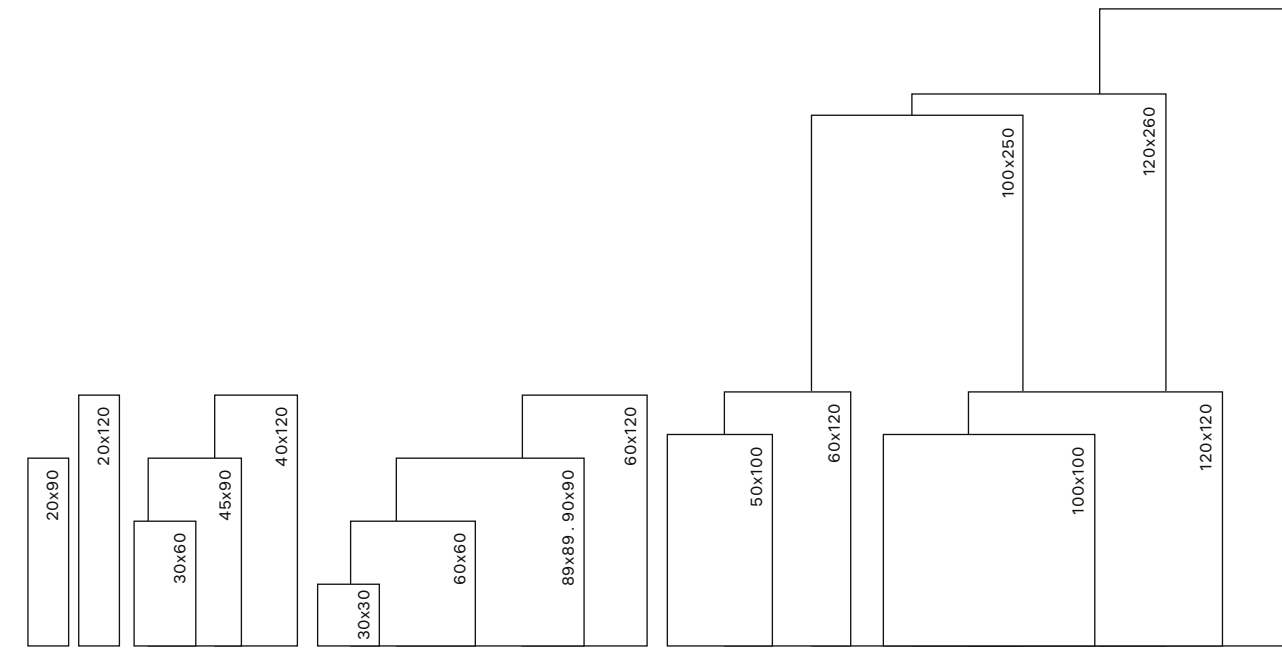

		LINEA																
		20x90	20x120	30x30	30x60	40x120	45x90	60x60	60x120	89x89	90x90	50x100	60x120	100x100	100x250	100x300	120x120	120x260
concept	P. 105				■		■	■	■		■							
cosmos	P. 273													■		■		
edge	P. 117				■			■			■							
endless	P. 027								■	■	■	■		■	■	■		
evoke	P. 071				■			■	■	■	■							
extreme	P. 219				■		■	■	■									
grove	P. 131		■			■												
hybrid	P. 059				■			■	■		■							
jungle	P. 083		■			■												
magnetic	P. 263													■		■		
natural	P. 187	■																
prestige	P. 093							■	■	■	■	■		■	■	■		
pure stone	P. 039				■			■	■		■	■		■	■	■		
slabstone	P. 171				■		■	■			■	■		■		■		
subway	P. 191				■		■	■			■	■		■		■		
tecnica	P. 225			■														
time 2.0	P. 201				■			■	■		■	■		■		■		
tool	P. 145						■	■			■		■				■	■
underground	P. 159						■	■			■							



# finishes' index

— index finitions . index fertigungen . índice acabamentos

		A	AS	ASR	E	E ASR	E NR	K	N	NR	SL	SM	P	TC	W
<b>concept</b>	P. 105	■		■						■					
<b>cosmos</b>	P. 273									■					
<b>edge</b>	P. 117			■						■			■	■	
<b>endless</b>	P. 027			■								■	■		
<b>evoke</b>	P. 071			■		■				■				■	
<b>extreme</b>	P. 219	■								■					
<b>grove</b>	P. 131		■			■			■						
<b>hybrid</b>	P. 059			■						■				■	
<b>jungle</b>	P. 083		■			■			■	■					
<b>magnetic</b>	P. 263									■					
<b>natural</b>	P. 187							■	■		■				
<b>prestige</b>	P. 093			■						■			■		
<b>pure stone</b>	P. 039	■		■		■				■					
<b>slabstone</b>	P. 171	■		■		■				■					
<b>subway</b>	P. 191	■				■				■					
<b>tecnic</b>	P. 225		■		■				■						■
<b>time 2.0</b>	P. 201			■			■			■			■		
<b>tool</b>	P. 145	■		■		■				■				■	
<b>underground</b>	P. 159									■					

## reference finishing

— référence  
— referenz  
— referênci

— finition  
— fertigung  
— acabamento

<b>A*</b>	soft shiny . adouci . halbpoliert . amaciado
<b>AS</b>	anti-slip . antidérapant . rutschfest . antiderrapante
<b>ASR</b>	anti-slip rectified . antidérapant rectifié . rutschfest rektifiziert . antiderrapante retificado
<b>E</b>	extra thick . forte épaisseur . überdicke fliese . espessurado
<b>E ASR*</b>	extra thick anti-slip . forte épaisseur antidérapant . rutschfestig überdicke fliese . espessurado antiderrapante
<b>E NR</b>	extra thick nat. rectified . forte épaisseur nat. rectifié . nat. rektifiziert überdicke fliese . espessurado nat. retificado
<b>K</b>	deck
<b>N</b>	natural . naturel . naturbelassen . natural
<b>NR</b>	nat. rectified . nat. rectifié . nat. rektifiziert . nat. retificado
<b>SL</b>	slat
<b>SM*</b>	smooth
<b>P*</b>	polished . poli . poliert . polido
<b>TC*</b>	touch
<b>W</b>	wavy . ondulé . wellig . ondulado

\* always rectified . toujours rectifié . immer rektifiziert . sempre retificado

# thickness' index

— index épaisseurs . index dicke . índice espessuras

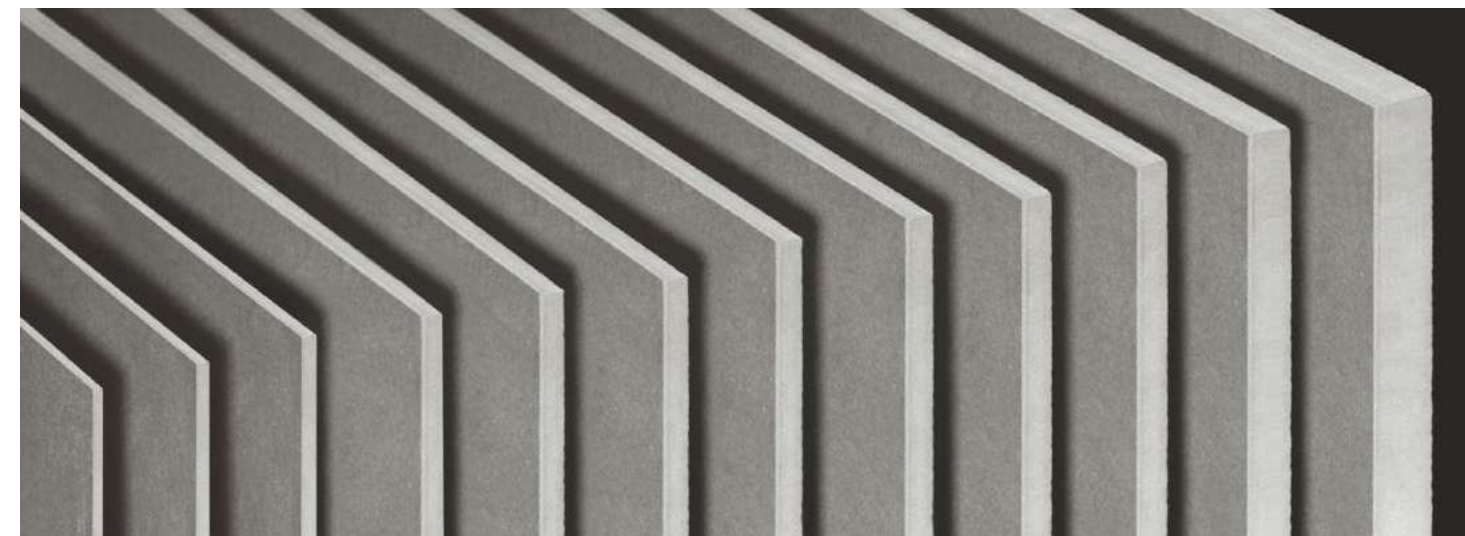

3,5mm 5,5mm 6mm 8,5mm 9mm 9,5mm 10mm 10,5mm 11mm 12mm 14mm 20mm

		LINEA												
		3,5mm	5,5mm	6mm	8mm	8,5mm	9mm	9,5mm	10mm	10,5mm	11mm	12mm	14mm	20mm
<b>concept</b>	P. 105						■	■	■					
<b>cosmos</b>	P. 273	■												
<b>edge</b>	P. 117								■	■	■			
<b>endless</b>	P. 027		■						■					
<b>evoke</b>	P. 071						■		■					■
<b>extreme</b>	P. 219						■	■	■					
<b>grove</b>	P. 131				■									■
<b>hybrid</b>	P. 059		■						■		■			
<b>jungle</b>	P. 083				■									■
<b>magnetic</b>	P. 263			■										
<b>natural</b>	P. 187							■						
<b>prestige</b>	P. 093		■				■		■					
<b>pure stone</b>	P. 039			■			■		■					■
<b>slabstone</b>	P. 171	■					■	■	■					■
<b>subway</b>	P. 191	■					■	■	■					■
<b>tecnic</b>	P. 225						■					■		
<b>time 2.0</b>	P. 201	■							■	■	■		■	
<b>tool</b>	P. 145			■			■	■	■					■
<b>underground</b>	P. 159						■	■	■					

index

anti-slip's

finishes

sizes

sizes +finishes  
+ thickness

thickness

colour map

collections

linea collections

useful information



# sizes' + finishes' + thickness' index

— index formats + finitions + épaisseurs . index formate + oberfläche + dicke . índice formatos + acabamentos + espessuras

		20x90	20x120	30x30	30x60	40x120	45x90	50x100	60x60	60x120	89x89	90x90	100x100	100x250	100x300	120x120	120x260
<b>concept</b>	P. 105				NR A 8,5mm		NR A ASR 9mm		NR A ASR 8,5mm	NR A 9,5mm		NR A 9,5mm					
<b>cosmos</b>	P. 273												NR 3,5mm		NR 3,5mm		
<b>edge</b>	P. 117				NR TC 10mm P 9,5mm				NR TC ASR 10mm P 9,5mm			NR TC 11mm P 10,5mm					
<b>endless</b>	P. 027							SM P 5,5mm		SM P 9,5mm	P 9,5mm	SM ASR 9,5mm	SM P 5,5mm	SM P 5,5mm	SM P 5,5mm		
<b>evoke</b>	P. 071				NR 8,5mm				NR TC ASR 8,5mm	NR TC 9,5mm E ASR 20mm		NR TC 9,5mm E ASR 20mm					
<b>extreme</b>	P. 219				NR A 8,5mm		NR A 9mm		NR A 8,5mm	NR A 9,5mm							
<b>grove</b>	P. 131		N AS 8mm			E ASR 20mm											
<b>hybrid</b>	P. 059				NR TC ASR 10mm				NR TC ASR 10mm	NR TC ASR 11mm		NR TC ASR 11mm					
<b>jungle</b>	P. 083		N NR AS 8mm			E ASR 20mm											
<b>magnetic</b>	P. 263												NR 6mm		NR 6mm		
<b>natural</b>	P. 187	N K SL 9mm															
<b>prestige</b>	P. 093							NR P 5,5mm	NR P 8,5mm	NR P 9,5mm	P 9,5mm	NR 9,5mm	NR P ASR 5,5mm	NR P 5,5mm	NR P 5,5mm		
<b>pure stone</b>	P. 039				NR A 8,5mm			NR 6mm	NR A ASR 8,5mm	NR A ASR 9,5mm		NR A ASR 9,5mm	NR 6mm	NR 6mm	NR 6mm		
<b>slabstone</b>	P. 171				NR 8,5mm		NR 9mm	NR 3,5mm	NR A ASR 8,5mm			NR 9,5mm	NR 3,5mm		NR 3,5mm		
<b>subway</b>	P. 191				NR 8,5mm		NR 9mm	NR 3,5mm	NR A ASR 8,5mm E ASR 20mm			NR 9,5mm	NR 3,5mm		NR 3,5mm		
<b>tecnica</b>	P. 225			N W AS 8,5mm E 12mm													
<b>time 2.0</b>	P. 201				NR ASR 10mm P 9,5mm			NR 3,5mm	NR ASR 10mm P 9,5mm	NR 11mm P 10,5mm		NR 11mm P 10,5mm	NR 3,5mm		NR 3,5mm		
<b>tool</b>	P. 145						NR A 9mm		NR TC A 8,5mm E ASR 20mm	NR 6mm		NR A ASR 9,5mm				NR 6mm	NR 6mm
<b>underground</b>	P. 159						NR 9mm		NR 8,5mm			NR 9,5mm					

# anti-slip's index

— index glissement . index rutschen . índice escorregamento

		DIN EN 16165 Annex B			DIN EN 16165 Annex A			DIN EN 16165 Annex C	AS/NZS 4586			ENV 12633 Class	
		R11	R10	R9	C	B	A	≥ 36	P5	P4	P3	3	2
<b>concept</b>	P. 105	■	■		■	■		■			■	■	■
<b>cosmos</b>	P. 273		■										
<b>edge</b>	P. 117	■	■		■	■		■			■		■
<b>endless</b>	P. 027 . 235		■			■		■			■		
<b>evoke</b>	P. 071	■	■		■	■		■		■	■		
<b>extreme</b>	P. 215			■		■		■				■	
<b>grove</b>	P. 131	■	■		■	■		■		■			
<b>hybrid</b>	P. 059	■	■		■	■		■	■	■		■	
<b>jungle</b>	P. 083	■	■		■	■		■		■			
<b>magnetic</b>	P. 263		■	■									
<b>natural</b>	P. 187	■		■	■		■	■					
<b>prestige</b>	P. 093 . 285		■										
<b>pure stone</b>	P. 039 . 255	■	■	■	■	■		■		■	■	■	
<b>slabstone</b>	P. 171 . 295	■	■	■	■	■		■		■			■
<b>subway</b>	P. 191 . 305		■	■		■	■	■			■		
<b>tecnica</b>	P. 225	■	■	■	■			■				■	
<b>time 2.0</b>	P. 201 . 315	■	■	■	■	■		■				■	■
<b>tool</b>	P. 145 . 273	■	■	■	■		■	■			■		
<b>underground</b>	P. 159		■					■			■		■

## special pieces

pièces spéciales . spezialteile . peças especiais

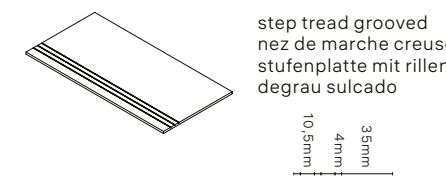

step tread grooved  
nez de marche creusé  
stufenplatte mit rillen  
degrau sulcado

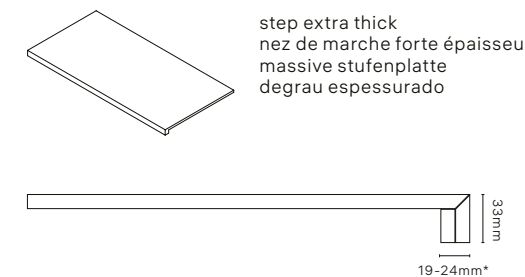

step extra thick  
nez de marche forte épaisseur  
massive stufenplatte  
degrau espessurado

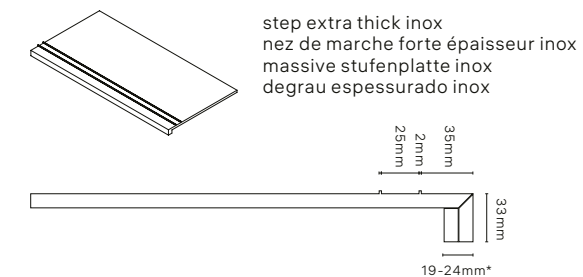

step extra thick inox  
nez de marche forte épaisseur inox  
massive stufenplatte inox  
degrau espessurado inox

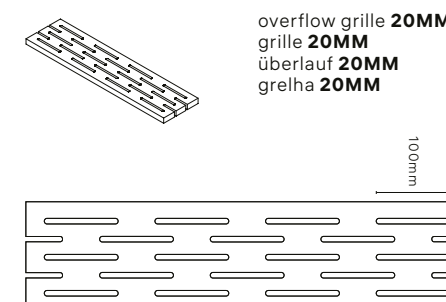

overflow grille **20MM**  
grille **20MM**  
überlauf **20MM**  
grelha **20MM**

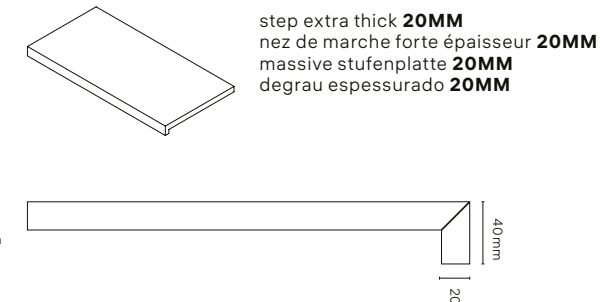

step extra thick **20MM**  
nez de marche forte épaisseur **20MM**  
massive stufenplatte **20MM**  
degrau espessurado **20MM**

\* Dimension will vary depending on the base tile thickness.  
\* La dimension varie selon l'épaisseur du carreau.  
\* das Maß variiert je nach Dicke der Fliese.  
\* A dimensão varia consoante a espessura do material cerâmico.



# colour map

— stone look

scale 1:3

slabstone white SL1 P.182



concept white CT1 P.112



pure stone white PS1 P.052



edge snow E01 P.126



hybrid white HB1 P.066



tecnica branco 44 P.226



concept beige CT2 P.112



underground snow UG1 P.166



tecnica granito preto 75 P.226



slabstone beige SL2 P.182



pure stone beige PS2 P.052



edge cream E02 P.126



tecnica granito beige 33 P.226



hybrid beige HB2 P.066



underground cream UG2 P.166



slabstone tortora SL3 P.182



# colour map

— stone look

1 / 2 / 3 ▶

index

colour map

chromatic look

concrete look

marble look

stone look

wood look

collections

linea collections

useful information

10

11

general catalogue . 2023

general catalogue . 2023



# colour map

— stone look

◀ 1 / 2 / 3

scale 1:3

concept light grey CT3 P.113



magnetic stone grey LMS3 P.271



pure stone light grey PS3 P.052



slabstone light grey SL4 P.183



pure stone grey PS4 P.053



underground silver UG3 P.167



hybrid tortora HB4 P.067



edge taupe E04 P.127



hybrid light grey HB3 P.067



edge silver E03 P.127



tecnica platina 41 P.226



tecnica granito cinza 36 P.226

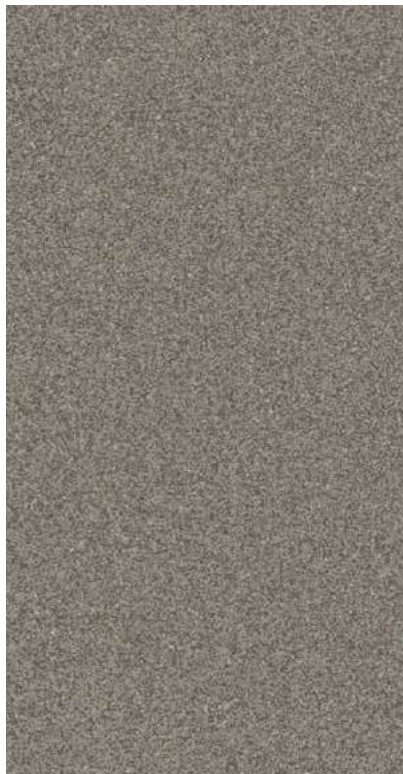

concept grey CT4 P.113



edge carbon E05 P.127



underground carbon UG4 P.167



hybrid black HB5 P.067



# colour map

stone look —

1 / 2 / 3 ▶

index

colour map

chromatic look

concrete look

marble look

stone look

wood look

collections

linea collections

useful information

12

13

general catalogue . 2023

general catalogue . 2023



# colour map

— stone look

◀ 1 / 2 / 3 ▶

slabstone grey SL5 P.183



tecnica preto 46 P.226



magnetic stone anthracite LMS4 P.271



scale 1:3

# colour map

— concrete look

1 / 2 ▶

subway white SW1 P.196



evoked white EV1 P.078



tool white TL1 P.154



evoked light grey EV3 P.079



extreme extra white EX6 P.222



edge snow E01 P.126



edge cream E02 P.126



evoked beige EV2 P.078





# colour map

— concrete look

scale 1:3

◀ 1 / 2

tool light grey TL2 P.155



edge silver E03 P.127



subway ash SW2 P.197



magnetic cement grey LMC1 P.270



evoked grey EV4 P.079



extreme low grey EX3 P.222



tool tortora TL3 P.154



subway clay SW3 P.196



edge taupe E04 P.127



tool grey TL4 P.155



edge carbon E05 P.127



subway smoke SW4 P.197



magnetic cement anthracite LMC2 P.270



# colour map

concrete look —

index

colour map

chromatic look

concrete look

marble look

stone look

wood look

collections

linea collections

useful information



# colour map

— wood look

scale 1:3

grove white GR1 P. 142



natural white NT1 P. 188



jungle beige JU1 P. 091



grove beige GR2 P. 142



natural cream NT2 P. 188



grove light brown GR5 P. 143



grove brown GR6 P. 143



natural brown NT5 P. 189



grove grey GR3 P. 142



natural grey NT3 P. 188



grove tortora GR4 P. 143



natural tortora NT4 P. 189



jungle grey JU3 P. 091



jungle brown JU2 P. 091



natural wenge NT6 P. 189



# colour map

wood look —

index

colour map

chromatic look

concrete look

marble look

stone look

wood look

collections

linea collections

useful information



# colour map

— marble look

scale 1:3

prestige calacata PT1 P.100



endless calacata gold ED1 P.034

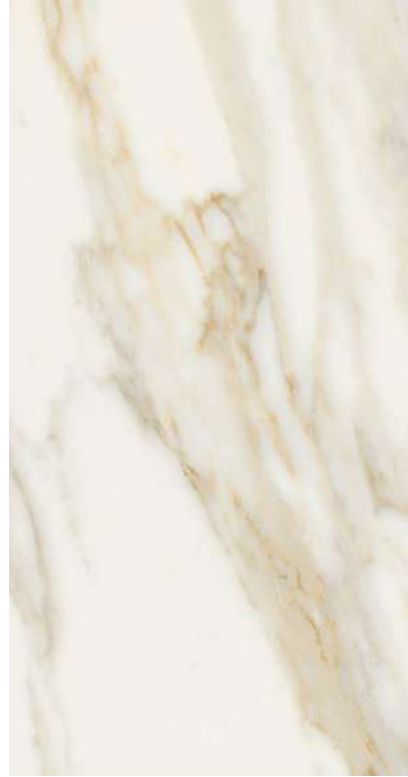

endless breccia capraia ED2 P.034



prestige travertino grey PT3 P.100



endless travertino ED3 P.034



prestige corinthian beige PT2 P.100



prestige fior di bosco tortora PT4 P.101



prestige emperador black PT5 P.101



endless port black ED4 P.035



endless amazonite ED5 P.035



# colour map

marble look —

index

colour map

chromatic look

concrete look

marble look

stone look

wood look

collections

linea collections

useful information



# colour map

— chromatic look

scale 1:3

time 2.0 snow T21 P.212



time 2.0 white T22 P.212



time 2.0 cream T23 P.212



time 2.0 beige T24 P.213



time 2.0 dove T25 P.213



cosmos corten LCM1 P.275



time 2.0 silver T26 P.214



time 2.0 grey T27 P.214



time 2.0 carbon T28 P.215

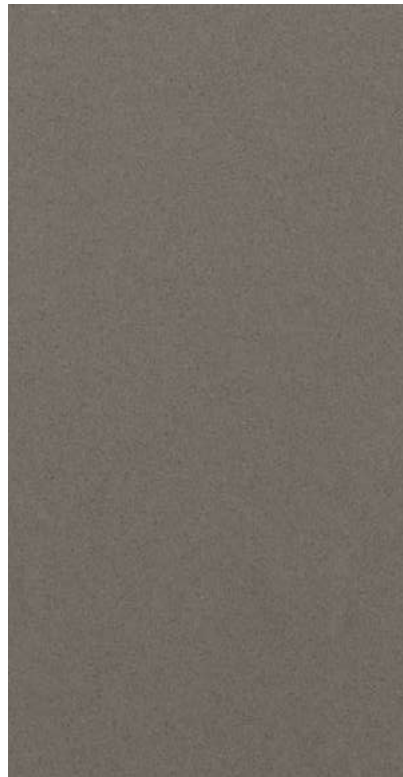

time 2.0 black T29 P.215

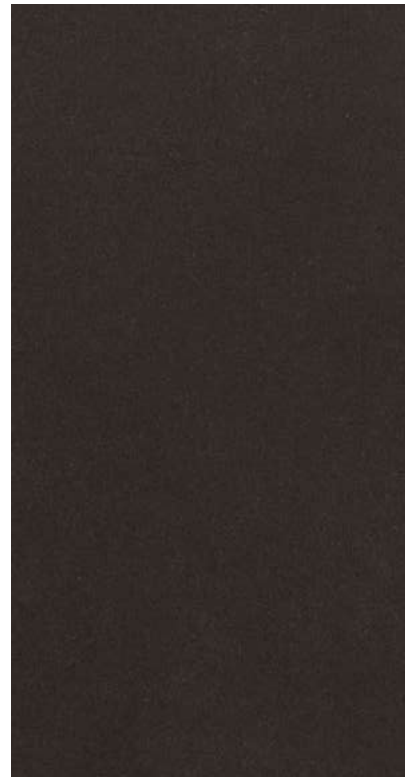

cosmos iron LCM2 P.275



# colour map

chromatic look —

index

colour map

chromatic look

concrete look

marble look

stone look

wood look

collections

linea collections

useful information

# collections

collections . kollektionen . coleções —

<b>concept</b>	P. 105
<b>edge</b>	P. 117
<b>endless</b>	P. 027
<b>evoke</b>	P. 071
<b>extreme</b>	P. 219
<b>grove</b>	P. 131
<b>hybrid</b>	P. 059
<b>jungle</b>	P. 083
<b>natural</b>	P. 187
<b>prestige</b>	P. 093
<b>pure stone</b>	P. 039
<b>slabstone</b>	P. 171
<b>subway</b>	P. 191
<b>tecnica</b>	P. 225
<b>time 2.0</b>	P. 201
<b>tool</b>	P. 145
<b>underground</b>	P. 159

25

general catalogue . 2023

**MARGRES**  
CERAMIC TILES

index

colour map

**collections**

concept

edge

endless

evoke

extreme

grove

hybrid

jungle

natural

prestige

pure stone

slabstone

subway

tecnica

time 2.0

tool

underground

linea collections

useful information





breccia capraia ED2 60x120 P

LAMINATED  
PORCELAIN  
STONEWARE

DIGITEK  
PORCELAIN  
STONEWARE

# endless

collection



100x300  
SM . P 5,5mm



100x250  
SM . P 5,5mm



100x100  
SM . P 5,5mm



50x100  
SM . P 5,5mm



60x120  
SM . P 9,5mm



90x90  
SM . ASR 9,5mm

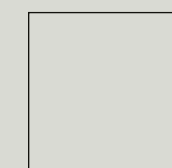

89x89  
P 9,5mm

↓  
DOWNLOAD  
CATALOGUE

↓  
DOWNLOAD  
TECHNICAL  
FEATURES

🌐  
VIEW  
ONLINE

rectified products . produits rectifiés . rektifizirte produkte . produtos retificados



calacatta  
gold  
ED1 . LED1

breccia  
capraia  
ED2 . LED2

travertino  
ED3 . LED3

port black  
ED4 . LED4

amazonite  
ED5 . LED5

UGL V2 R10  
SM . ASR P

**PROTECT**

Antibacterial for Life.

**MARGRES**  
CERAMIC TILES

index

colour map

**collections**

concept

edge

**endless**

evoke

extreme

grove

hybrid

jungle

natural

prestige

pure stone

slabstone

subway

tecnica

time 2.0

tool

underground

linea collections

useful information



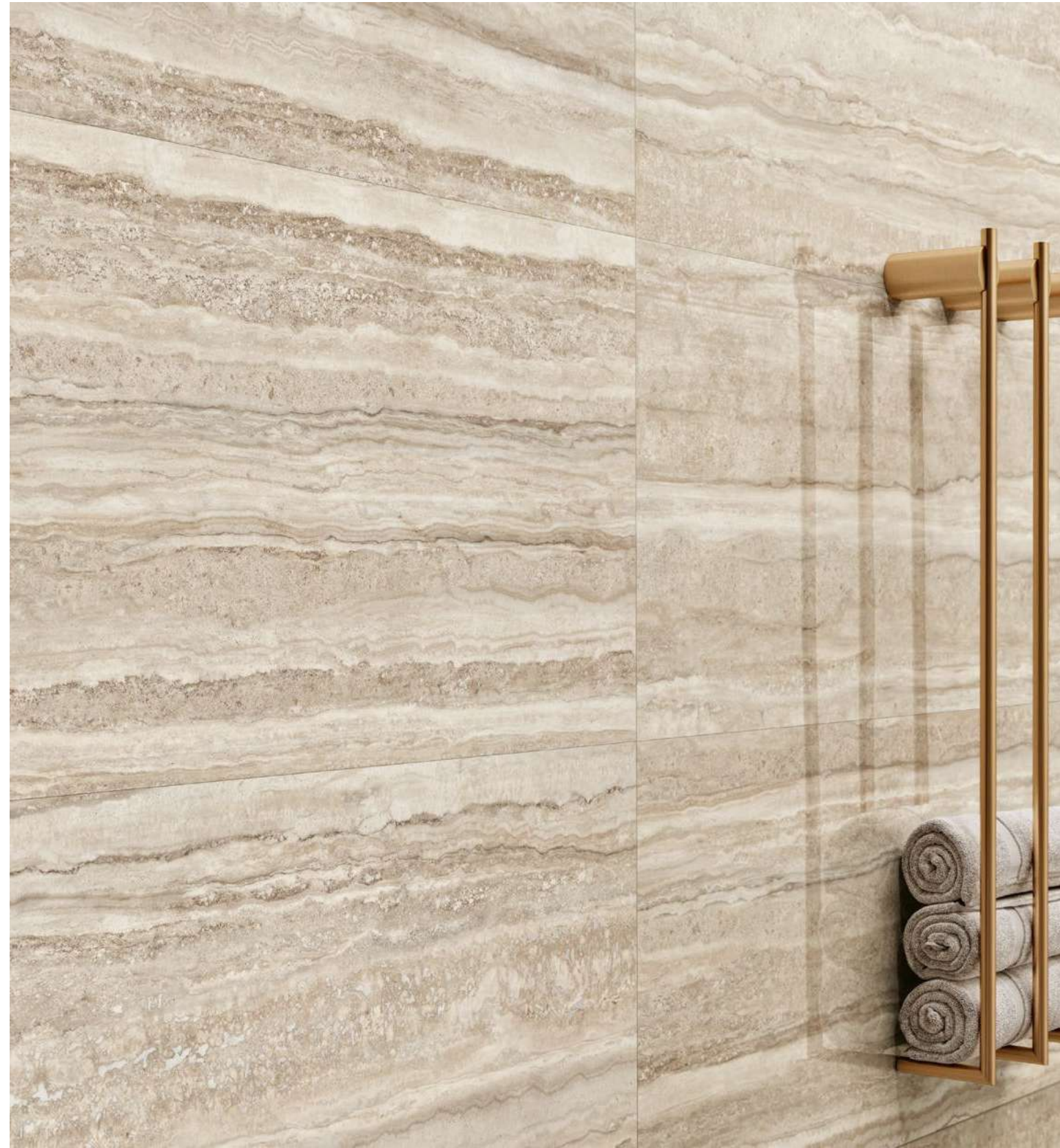

index

colour map

**collections**

concept

edge

**endless**

evoke

extreme

grove

hybrid

jungle

natural

prestige

pure stone

slabstone

subway

tecnica

time 2.0

tool

underground

linea collections

useful information









32

general catalogue, 2023

calacatta gold ED1 60x120 SM



33

general catalogue, 2023

amazonite ED5 60x120 P

index

colour map

collections

concept

edge

endless

evoke

extreme

grove

hybrid

jungle

natural

prestige

pure stone

slabstone

subway

tecnica

time 2.0

tool

underground

linea collections

useful information





<b>89x89</b> . 35"x35"	9,5mm	<b>P</b>	-	MG-4470
	9,5mm	<b>SM</b>	-	MG-3955
<b>90x90</b> . 36"x36"	9,5mm	<b>ASR</b>	R10	MG-3955
	9,5mm	<b>SM</b>	-	MG-4680
<b>60x120</b> . 24"x48"	9,5mm	<b>P</b>	-	MG-5160

<b>LINEA</b>				
<b>50x100</b> . 19,6"x39,4"	5,5mm	<b>SM</b>	-	M3-1930
	5,5mm	<b>P</b>	-	M3-2330
<b>100x100</b> . 39,4"x39,4"	5,5mm	<b>SM</b>	-	M3-2730
	5,5mm	<b>P</b>	-	M3-3130
<b>100x250</b> . 39,4"x98,4"	5,5mm	<b>SM</b>	-	M3-3530
	5,5mm	<b>P</b>	-	M3-3830
<b>100x300</b> . 39,4"x118"	5,5mm	<b>SM</b>	-	M3-4230
	5,5mm	<b>P</b>	-	M3-4630



<b>89x89</b> . 35"x35"	9,5mm	<b>P</b>	-	MG-4470
	9,5mm	<b>SM</b>	-	MG-3955
<b>90x90</b> . 36"x36"	9,5mm	<b>ASR</b>	R10	MG-3955
	9,5mm	<b>SM</b>	-	MG-4680
<b>60x120</b> . 24"x48"	9,5mm	<b>P</b>	-	MG-5160

<b>LINEA</b>				
<b>50x100</b> . 19,6"x39,4"	5,5mm	<b>SM</b>	-	M3-1930
	5,5mm	<b>P</b>	-	M3-2330
<b>100x100</b> . 39,4"x39,4"	5,5mm	<b>SM</b>	-	M3-2730
	5,5mm	<b>P</b>	-	M3-3130
<b>100x250</b> . 39,4"x98,4"	5,5mm	<b>SM</b>	-	M3-3530
	5,5mm	<b>P</b>	-	M3-3830
<b>100x300</b> . 39,4"x118"	5,5mm	<b>SM</b>	-	M3-4230
	5,5mm	<b>P</b>	-	M3-4630

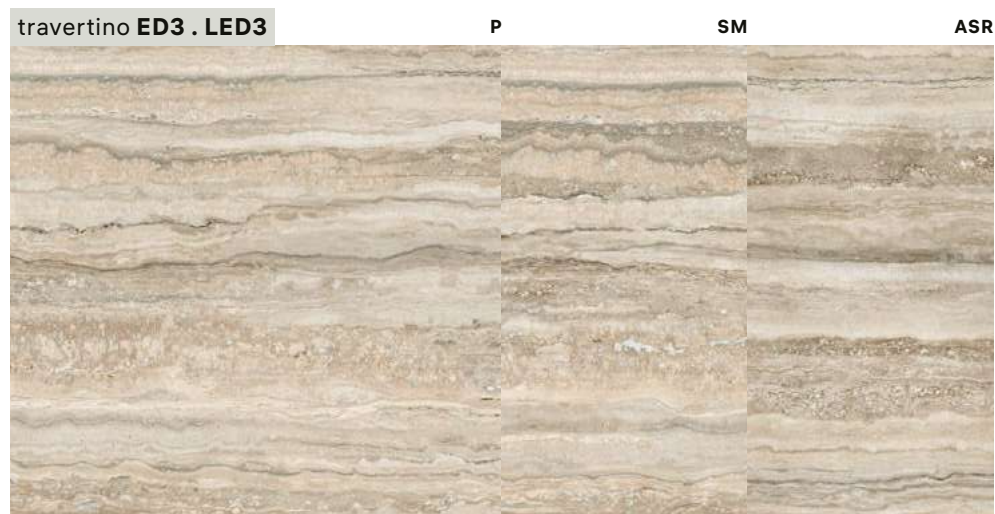

<b>89x89</b> . 35"x35"	9,5mm	<b>P</b>	-	MG-4470
	9,5mm	<b>SM</b>	-	MG-3955
<b>90x90</b> . 36"x36"	9,5mm	<b>ASR</b>	R10	MG-3955
	9,5mm	<b>SM</b>	-	MG-4680
<b>60x120</b> . 24"x48"	9,5mm	<b>P</b>	-	MG-5160

<b>LINEA</b>				
<b>50x100</b> . 19,6"x39,4"	5,5mm	<b>SM</b>	-	M3-1930
	5,5mm	<b>P</b>	-	M3-2330
<b>100x100</b> . 39,4"x39,4"	5,5mm	<b>SM</b>	-	M3-2730
	5,5mm	<b>P</b>	-	M3-3130
<b>100x250</b> . 39,4"x98,4"	5,5mm	<b>SM</b>	-	M3-3530
	5,5mm	<b>P</b>	-	M3-3830
<b>100x300</b> . 39,4"x118"	5,5mm	<b>SM</b>	-	M3-4230
	5,5mm	<b>P</b>	-	M3-4630

<b>89x89</b> . 35"x35"	9,5mm	<b>P</b>	-	MG-4470
<b>60x120</b> . 24"x48"	9,5mm	<b>P</b>	-	MG-5160

<b>LINEA</b>				
<b>50x100</b> . 19,6"x39,4"	5,5mm	<b>P</b>	-	M3-2330
<b>100x100</b> . 39,4"x39,4"	5,5mm	<b>P</b>	-	M3-3130
<b>100x250</b> . 39,4"x98,4"	5,5mm	<b>P</b>	-	M3-3830
<b>100x300</b> . 39,4"x118"	5,5mm	<b>P</b>	-	M3-4630

<b>89x89</b> . 35"x35"	9,5mm	<b>P</b>	-	MG-4470
<b>60x120</b> . 24"x48"	9,5mm	<b>P</b>	-	MG-5160

<b>LINEA</b>				
<b>50x100</b> . 19,6"x39,4"	5,5mm	<b>P</b>	-	M3-2330
<b>100x100</b> . 39,4"x39,4"	5,5mm	<b>P</b>	-	M3-3130
<b>100x250</b> . 39,4"x98,4"	5,5mm	<b>P</b>	-	M3-3830
<b>100x300</b> . 39,4"x118"	5,5mm	<b>P</b>	-	M3-4630

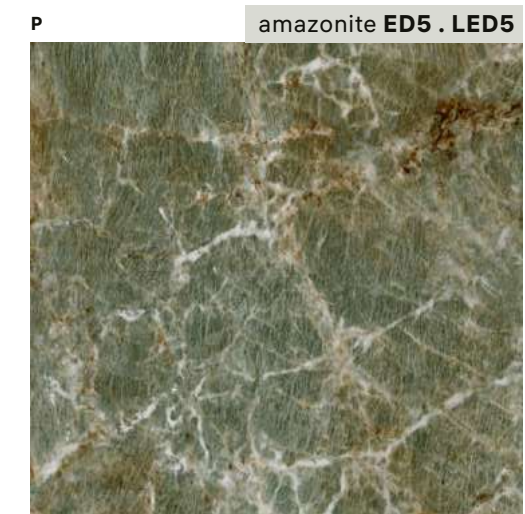
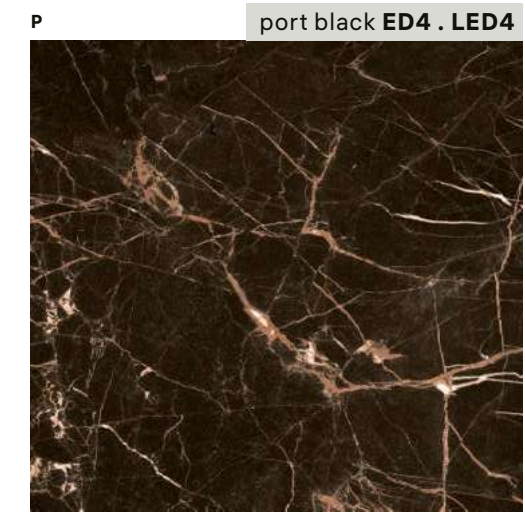

Products with a polished finish are more sensitive to abrasion and stains, what requires special conditions. Please see page 348 in chapter 09.  
Les produits à finition polie sont plus sensibles à l'abrasion et aux taches, ce qui requiert des conditions particulières. Veuillez-vous consulter la page 348 du chapitre 09.  
Produkte mit einer polierten Oberfläche sind empfindlicher gegen Abrieb und Fleckenbildung, was besondere Bedingungen erfordert. Bitte beachten Sie Seite 348 in Kapitel 09.  
Os produtos com acabamento polido são mais sensíveis à abrasão e às manchas, o que requer condições especiais. Por favor consulte a página 348 no capítulo 09.

**PROTECT**

Antibacterial for Life.

An exclusive line of extremely high performance antimicrobial floor and wall tiles, designed for healthy, safe and protected living spaces. Available only in smooth and polished finishes.

Une ligne exclusive de sols et revêtements antibactériens aux performances très élevées, pour un habitat sain, sûr et protégé. Uniquement disponible dans les finitions smooth et poli.

Eine exklusive Linie an hochwertigen Fußböden und antibakteriellen Wandverkleidungen, für ein gesundes, sicheres und geschütztes Leben. Nur auf smooth und poliert erhältlich.

Uma linha exclusiva de pavimentos e revestimentos antimicrobianos de altíssima performance, projetada para ambientes saudáveis, seguros e protegidos. Disponível unicamente nos acabamentos smooth e polido.



decors

décorations . dekorationen . decorações

9,5MM



mosaic endless 3,5x3,5  
calacatta gold  
**30x30** . 12"x12"  
**SM** MG-9580  
**P** MG-9830



mosaic endless 3,5x3,5  
breccia capraia  
**30x30** . 12"x12"  
**SM** MG-9580  
**P** MG-9830



mosaic endless 3,5x3,5  
travertino  
**30x30** . 12"x12"  
**SM** MG-9580  
**P** MG-9830

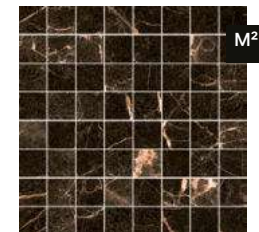

mosaic endless 3,5x3,5  
port black  
**30x30** . 12"x12"  
**P** MG-9830



mosaic endless 3,5x3,5  
amazonite  
**30x30** . 12"x12"  
**P** MG-9830

special pieces

pièces spéciales . spezialteile . peças especiais

9,5 MM

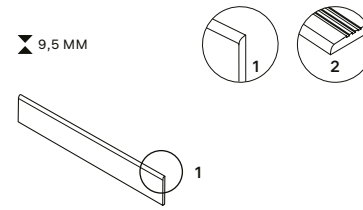

skirting  
plinthe  
sockel  
rodapé boleado  
**8x89** . 3,2"x35"  
**P** MP-6270  
**8x90** . 3,2"x36"  
**SM** MP-6260  
**8x120** . 3,2"x48"  
**SM** MP-6260  
**P** MP-6270

step tread grooved  
nez de marche creusé  
stufenplatte mit rillen  
degrau sulcado  
**30x89** . 12"x35"  
**P** MP-6445  
**30x90** . 12"x36"  
**SM . ASR** MP-6430  
**30x120** . 12"x48"  
**SM** MP-6445  
**P** MP-6470

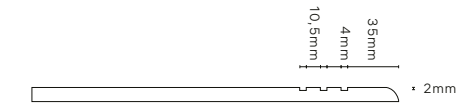

9,5 MM

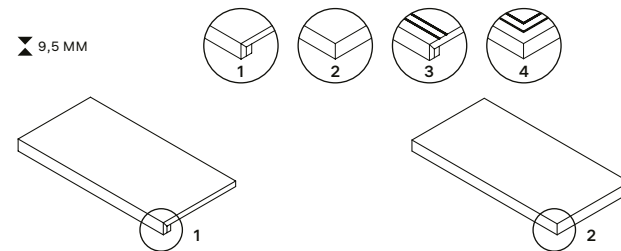

step extra thick  
nez de marche forte épaisseur  
massive stufenplatte  
degrau espessurado  
**30x89** . 12"x35"  
**P** MP-6590  
**30x90** . 12"x36"  
**SM . ASR** MP-6590  
**30x120** . 12"x48"  
**SM . P** MP-6650

step extra thick corner\*  
nez de marche forte épaisseur angle\*  
ecke massive stufenplatte\*  
degrau espessurado canto\*  
**30x89** . 12"x35"  
**P** MP-6650  
**30x90** . 12"x36"  
**SM . ASR** MP-6650  
**30x120** . 12"x48"  
**SM . P** MP-6690

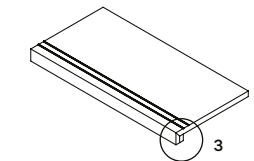

step extra thick inox  
nez de marche forte épaisseur inox  
massive stufenplatte inox  
degrau espessurado inox  
**30x89** . 12"x35"  
**P** MP-6640  
**30x90** . 12"x36"  
**SM** MP-6640  
**30x120** . 12"x48"  
**SM . P** MP-6670

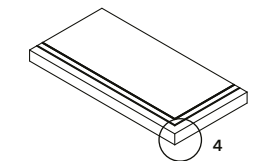

step extra thick corner inox\*  
nez de marche forte épaisseur angle inox\*  
ecke massive stufenplatte inox\*  
degrau espessurado canto inox\*  
**30x89** . 12"x35"  
**P** MP-6690  
**30x90** . 12"x36"  
**SM** MP-6690  
**30x120** . 12"x48"  
**SM . P** MP-6710

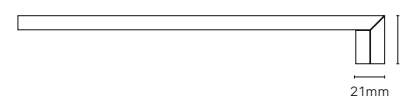

step extra thick corner . nez de marche forte épaisseur angle  
ecke massive stufenplatte . degrau espessurado canto

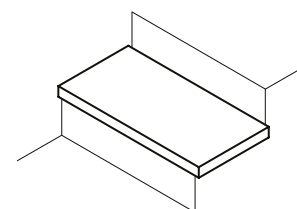

right corner . angle droit  
rechten ecke . canto direito

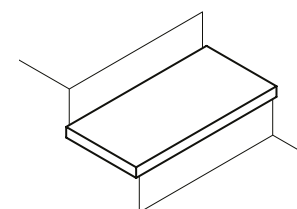

left corner . angle gauche  
links ecke . canto esquerdo



step extra thick corner inox . nez de marche forte épaisseur angle inox  
ecke massive stufenplatte inox . degrau espessurado canto inox

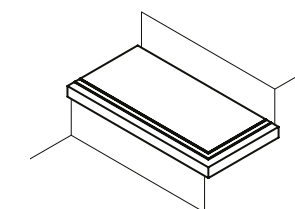

right corner . angle droit  
rechten ecke . canto direito

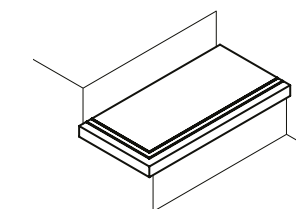

left corner . angle gauche  
links ecke . canto esquerdo

Available in all colours  
Disponible dans toutes les couleurs  
Erhältlich in allen Farben  
Disponível em todas as cores

\*Available in right and left corner  
\*Disponible dans les coin droit et gauche  
\*Erhältlich in der rechten Ecke und links  
\*Disponível no canto direito e esquerdo

Mosaic decors are net mounted. All decors may feature shade variations regarding the corresponding floor/wall tile standard tile.  
Les décorations Mosaic sont sur trame. Toutes les décorations peuvent souffrir variations de tonalité par rapport aux carreaux base.  
Die Mosaic Dekoration liegen auf einem Netz. Alle Dekorationen können im Vergleich zu den jeweiligen Grundiesen Farbunterschiede aufweisen.  
As decorações Mosaic são sobre rede. Todas as decorações podem sofrer variações de tonalidade em relação aos respectivos mosaicos base.





white PS1 90x90 NR . grey PS4 NR . listel brushed gold 1x120

LAMINATED  
PORCELAIN  
STONEWARE

FULL BODY  
PORCELAIN

## pure stone

collection



100x300  
NR 6mm

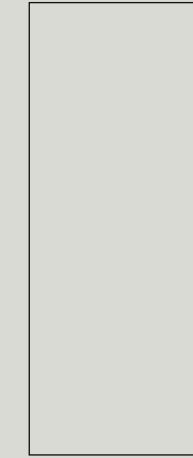

100x250  
NR 6mm

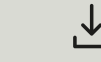

DOWNLOAD  
CATALOGUE



DOWNLOAD  
TECHNICAL  
FEATURES



VIEW  
ONLINE



DOWNLOAD  
CATALOGUE  
OUTDOOR  
EXTRA THICK



100x100  
NR 6mm



50x100  
NR 6mm

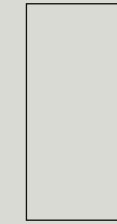

60x120  
NR . A 9,5mm  
ASR 9,5mm  
E ASR 20mm

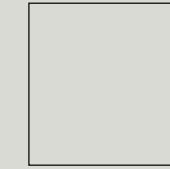

90x90  
NR . A 9,5mm  
ASR 9,5mm

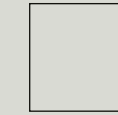

60x60  
NR . A 8,5mm  
ASR 8,5mm



30x60  
NR . A 8,5mm

rectified products . produits rectifiés . rektifizierte produkte . produtos retificados



white  
PS1 . LPS1

beige  
PS2 . LPS2

light grey  
PS3 . LPS3

grey  
PS4 . LPS4

forge white  
LPS1F

forge light grey  
LPS3F

UGL V2 R11 R10 R9



PROTECT®

Antibacterial for Life.

pour plus d'informations, consultez  
<https://evaluation.cstb.fr>

MARGRES  
CERAMIC TILES

index

colour map

collections

concept

edge

endless

evoke

extreme

grove

hybrid

jungle

natural

prestige

pure stone

slabstone

subway

tecnica

time 2.0

tool

underground

linea collections

useful information





40

general catalogue 2023

general catalogue 2023









light grey PS3 90x90 A . mosaic circles white light grey 28x31,5 A

index

colour map

collections

concept

edge

endless

evoke

extreme

grove

hybrid

jungle

natural

prestige

**pure stone**

slabstone

subway

tecnica

time 2.0

tool

underground

linea collections

useful information





chevron grey 48x64 A



beige PS2 90x90 A

index

colour map

collections

concept

edge

endless

evoke

extreme

grove

hybrid

jungle

natural

prestige

**pure stone**

slabstone

subway

tecnica

time 2.0

tool

underground

linea collections

useful information



concept

edge

endless

evoke

extreme

grove

hybrid

jungle

natural

prestige

**pure stone**

slabstone

subway

tecnica

time 2.0

tool

underground

linea collections

useful information



pure stone  
collection

pure stone  
collection

index

colour map

collections

concept

edge

endless

evoke

extreme

grove

hybrid

jungle

natural

prestige

**pure stone**

slabstone

subway

tecnica

time 2.0

tool

underground

linea collections

useful information

50

general catalogue - 2023

51

general catalogue - 2023

grey PS4 60x120 ASR - grey PS4 60x120 E ASR



**pure stone**  
collection

white **PS1 . LPS1** A NR ASR E ASR



<b>30x60</b> . 12"x24"	8,5mm	<b>NR</b>	R10	MG-2095
	8,5mm	<b>A</b>	-	MG-2370
<b>60x60</b> . 24"x24"	8,5mm	<b>NR</b>	R10	MG-2765
	8,5mm	<b>A</b>	-	MG-3080
	8,5mm	<b>ASR</b>	R11	MG-2765
<b>90x90</b> . 36"x36"	9,5mm	<b>NR</b>	R10	MG-3960
	9,5mm	<b>A</b>	-	MG-4290
	9,5mm	<b>ASR</b>	R11	MG-3960
<b>60x120</b> . 24"x48"	9,5mm	<b>NR</b>	R10	MG-4695
	9,5mm	<b>A</b>	-	MG-4970
	9,5mm	<b>ASR</b>	R11	MG-4695
	20mm	<b>E ASR</b>	R11	MG-7490

**LINEA**

<b>50x100</b> . 19,6"x39,4"	6mm	<b>NR</b>	R9	M3-5230
<b>100x100</b> . 39,4"x39,4"	6mm	<b>NR</b>	R9	M3-6230
<b>100x250</b> . 39,4"x98,4"	6mm	<b>NR</b>	R9	M3-7300
<b>100x300</b> . 39,4"x118"	6mm	<b>NR</b>	R9	M3-7730

beige **PS2 . LPS2** A NR ASR E ASR



<b>30x60</b> . 12"x24"	8,5mm	<b>NR</b>	R10	MG-2095
	8,5mm	<b>A</b>	-	MG-2370
<b>60x60</b> . 24"x24"	8,5mm	<b>NR</b>	R10	MG-2765
	8,5mm	<b>A</b>	-	MG-3080
	8,5mm	<b>ASR</b>	R11	MG-2765
<b>90x90</b> . 36"x36"	9,5mm	<b>NR</b>	R10	MG-3960
	9,5mm	<b>A</b>	-	MG-4290
	9,5mm	<b>ASR</b>	R11	MG-3960
<b>60x120</b> . 24"x48"	9,5mm	<b>NR</b>	R10	MG-4695
	9,5mm	<b>A</b>	-	MG-4970
	9,5mm	<b>ASR</b>	R11	MG-4695
	20mm	<b>E ASR</b>	R11	MG-7490

**LINEA**

<b>50x100</b> . 19,6"x39,4"	6mm	<b>NR</b>	R9	M3-5230
<b>100x100</b> . 39,4"x39,4"	6mm	<b>NR</b>	R9	M3-6230
<b>100x250</b> . 39,4"x98,4"	6mm	<b>NR</b>	R9	M3-7300
<b>100x300</b> . 39,4"x118"	6mm	<b>NR</b>	R9	M3-7730

light grey **PS3 . LPS3** A NR ASR E ASR



<b>30x60</b> . 12"x24"	8,5mm	<b>NR</b>	R10	MG-2095
	8,5mm	<b>A</b>	-	MG-2370
<b>60x60</b> . 24"x24"	8,5mm	<b>NR</b>	R10	MG-2765
	8,5mm	<b>A</b>	-	MG-3080
	8,5mm	<b>ASR</b>	R11	MG-2765
<b>90x90</b> . 36"x36"	9,5mm	<b>NR</b>	R10	MG-3960
	9,5mm	<b>A</b>	-	MG-4290
	9,5mm	<b>ASR</b>	R11	MG-3960
<b>60x120</b> . 24"x48"	9,5mm	<b>NR</b>	R10	MG-4695
	9,5mm	<b>A</b>	-	MG-4970
	9,5mm	<b>ASR</b>	R11	MG-4695
	20mm	<b>E ASR</b>	R11	MG-7490

**LINEA**

<b>50x100</b> . 19,6"x39,4"	6mm	<b>NR</b>	R9	M3-5230
<b>100x100</b> . 39,4"x39,4"	6mm	<b>NR</b>	R9	M3-6230
<b>100x250</b> . 39,4"x98,4"	6mm	<b>NR</b>	R9	M3-7300
<b>100x300</b> . 39,4"x118"	6mm	<b>NR</b>	R9	M3-7730

**pure stone**  
collection

E ASR ASR NR A grey **PS4 . LPS4**

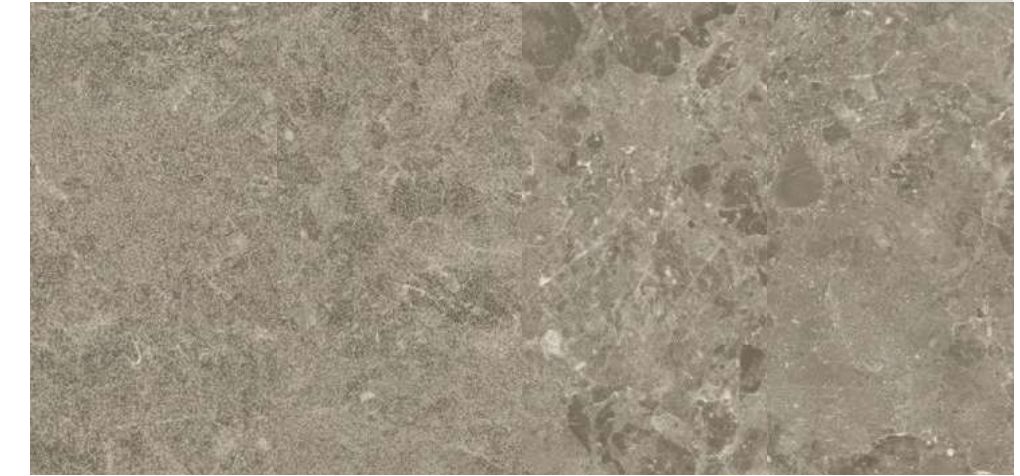

<b>30x60</b> . 12"x24"	8,5mm	<b>NR</b>	R10	MG-2095
	8,5mm	<b>A</b>	-	MG-2370
<b>60x60</b> . 24"x24"	8,5mm	<b>NR</b>	R10	MG-2765
	8,5mm	<b>A</b>	-	MG-3080
	8,5mm	<b>ASR</b>	R11	MG-2765
<b>90x90</b> . 36"x36"	9,5mm	<b>NR</b>	R10	MG-3960
	9,5mm	<b>A</b>	-	MG-4290
	9,5mm	<b>ASR</b>	R11	MG-3960
<b>60x120</b> . 24"x48"	9,5mm	<b>NR</b>	R10	MG-4695
	9,5mm	<b>A</b>	-	MG-4970
	9,5mm	<b>ASR</b>	R11	MG-4695
	20mm	<b>E ASR</b>	R11	MG-7490

**LINEA**

<b>50x100</b> . 19,6"x39,4"	6mm	<b>NR</b>	R9	M3-5230
<b>100x100</b> . 39,4"x39,4"	6mm	<b>NR</b>	R9	M3-6230
<b>100x250</b> . 39,4"x98,4"	6mm	<b>NR</b>	R9	M3-7300
<b>100x300</b> . 39,4"x118"	6mm	<b>NR</b>	R9	M3-7730

NR forge white **LPS1F**



**LINEA**

<b>50x100</b> . 19,6"x39,4"	6mm	<b>NR</b>	R10	M3-5230
<b>100x100</b> . 39,4"x39,4"	6mm	<b>NR</b>	R10	M3-6230
<b>100x250</b> . 39,4"x98,4"	6mm	<b>NR</b>	R10	M3-7300
<b>100x300</b> . 39,4"x118"	6mm	<b>NR</b>	R10	M3-7730

NR forge light grey **LPS3F**



**LINEA**

<b>50x100</b> . 19,6"x39,4"	6mm	<b>NR</b>	R10	M3-5230
<b>100x100</b> . 39,4"x39,4"	6mm	<b>NR</b>	R10	M3-6230
<b>100x250</b> . 39,4"x98,4"	6mm	<b>NR</b>	R10	M3-7300
<b>100x300</b> . 39,4"x118"	6mm	<b>NR</b>	R10	M3-7730

index

colour map

collections

concept

edge

endless

evoke

extreme

grove

hybrid

jungle

natural

prestige

**pure stone**

slabstone

subway

tecnica

time 2.0

tool

underground

linea collections

useful information

**PROTECT**

Antibacterial for Life.

An exclusive line of extremely high performance antimicrobial floor and wall tiles, designed for healthy, safe and protected living spaces. Available only in natural rectified and soft shiny finishes.  
 Une ligne exclusive de sols et revêtements antibactériens aux performances très élevées, pour un habitat sain, sûr et protégé. Uniquement disponible dans les finitions finitions naturel et adouci.  
 Eine exklusive Linie an hochwertigen Fußböden und antibakteriellen Wandverkleidungen, für ein gesundes, sicheres und geschütztes Leben. Nur auf rektifiziert naturbelassen und halbpoliert erhältlich.  
 Uma linha exclusiva de pavimentos e revestimentos antimicrobianos de altíssima performance, projetada para ambientes saudáveis, seguros e protegidos. Disponível unicamente nos acabamentos natural retificado e amaciado.





decors

décorations . dekorationen . decorações

8,5MM



mosaic pure stone 5x5  
(all colours)  
30x30 . 12"x12"  
A MG-9745



bricks pure stone  
(all colours)  
30x60 . 12"x24"  
A MP-6350

8,5MM



mosaic circles pure stone  
5x5 white beige  
28x31,5 . 11"x12,4"  
A MP-6488



mosaic circles pure stone  
5x5 white light grey  
28x31,5 . 11"x12,4"  
A MP-6488



mosaic circles pure stone  
5x5 grey  
28x31,5 . 11"x12,4"  
A MP-6488

listel brushed gold\*

1x1x120 . 0,4"x0,4"x47"  
MP-6500

listel brushed silver\*

1x1x120 . 0,4"x0,4"x47"  
MP-6520

listel brushed copper\*

1x1x120 . 0,4"x0,4"x47"  
MP-6560

\*Decorative pieces with precious metals are sensitive to acid attacks.

\*Les pièces décoratives en métaux précieux sont sensibles aux attaques d'acides.

\*Dekorative teile mit Edelmetallen sind gegen Säure empfindlich.

\*Peças decorativas com metais preciosos são sensíveis aos ataques ácidos.

Mosaic and Brick decors are net mounted. All decors may feature shade variations regarding the corresponding floor/wall tile standard tile.

Les décorations Mosaic et Brick sont sur trame. Toutes les décorations peuvent souffrir variations de tonalité par rapport aux carreaux base.

Die Mosaic und Brick Dekoration liegen auf einem Netz. Alle Dekorationen können im Vergleich zu den jeweiligen Grundiesen Farbunterschiede aufweisen.

As decorações Mosaic and Brick são sobre rede. Todas as decorações podem sofrer variações de tonalidade em relação aos respectivos mosaicos base.



## pure stone

collection

### decors

décorations . dekorationen . decorações

8,5MM



mase pure stone (all colours)

60x60 . 24"x24"

A MG-9720

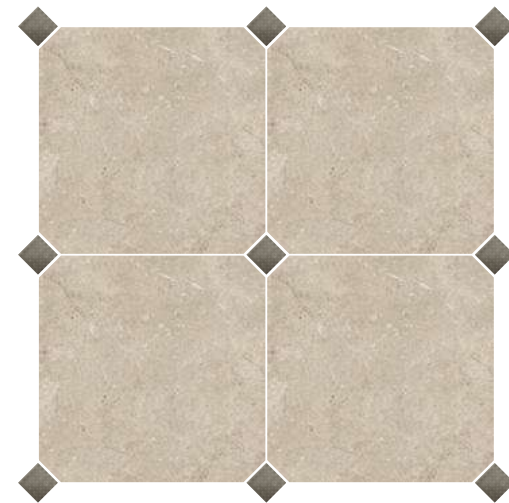

Example of 4 pieces Mase 60x60 and Insert Pure Stone Silver 10x10 composition.

Exemple de composition avec 4 pièces Mase 60x60 et Insert Pure Stone Silver 10x10.

Ein Beispiel für die Zusammensetzung mit 4 Teilen Mase 60x60 und Insert Pure Stone Silver 10x10.

Exemplo de composição com 4 peças Mase 60x60 e Insert Pure Stone Silver 10x10.



insert pure stone silver\*

10x10 . 4"x4"

MP-6150

9,5MM



chevron pure stone (all colours)

48x64 . 19"x25"

A MG-9735

(sold per two pieces set\_ vendu à la paire\_ Paarweise verkauft\_ vendida ao par)

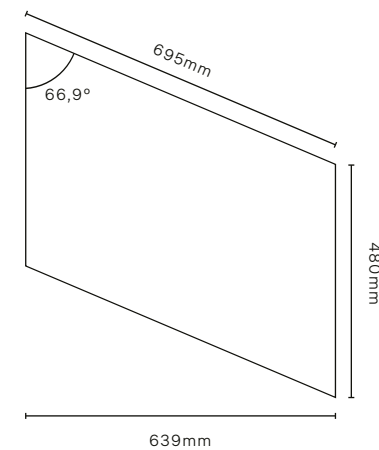

### special pieces

pièces spéciales . spezialteile . peças especiais

9,5 . 8,5MM

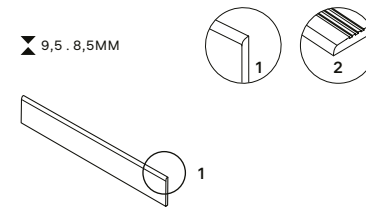

skirting  
plinthe  
sockel  
rodapé boleado

8x60 . 3,2"x24"

NR MP-6170

A MP-6180

8x90 . 3,2"x36"

NR MP-6260

A MP-6270

8x120 . 3,2"x48"

NR MP-6260

A MP-6270

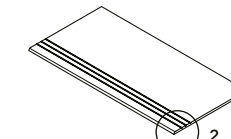
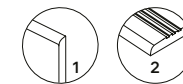

step tread grooved  
nez de marche creusé  
stufenplatte mit rillen  
degrau sulcado

30x60 . 12"x24"

NR . ASR MP-6240

A MP-6270

30x90 . 12"x36"

NR . ASR MP-6430

A MP-6445

30x120 . 12"x48"

NR . ASR MP-6445

A MP-6470

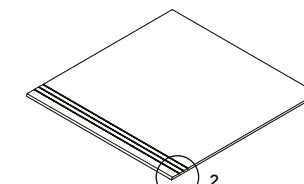

step tread grooved  
nez de marche creusé  
stufenplatte mit rillen  
degrau sulcado

60x60 . 24"x24"

NR . ASR MP-6400

A MP-6430

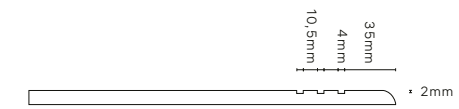

9,5 . 8,5MM

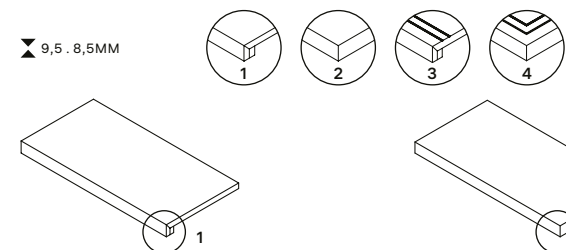

step extra thick  
nez de marche forte épaisseur  
massive stufenplatte  
degrau espessurado

30x60 . 12"x24"

NR . A . ASR MP-6560

30x90 . 12"x36"

NR . A . ASR MP-6590

30x120 . 12"x48"

NR . A . ASR MP-6650

step extra thick corner\*  
nez de marche forte épaisseur angle\*  
ecke massive stufenplatte\*  
degrau espessurado canto\*

30x60 . 12"x24"

NR . A . ASR MP-6630

30x90 . 12"x36"

NR . A . ASR MP-6650

30x120 . 12"x48"

NR . A . ASR MP-6690

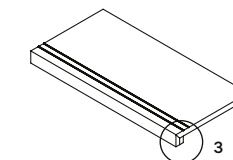

step extra thick inox  
nez de marche forte épaisseur inox  
massive stufenplatte inox  
degrau espessurado inox

30x60 . 12"x24"

NR . A MP-6580

30x90 . 12"x36"

NR . A MP-6640

30x120 . 12"x48"

NR . A MP-6670

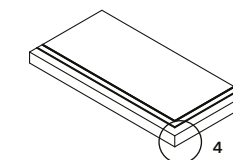

step extra thick corner inox\*  
nez de marche forte épaisseur angle inox\*  
ecke massive stufenplatte inox\*  
degrau espessurado canto inox\*

30x60 . 12"x24"

NR . A MP-6650

30x90 . 12"x36"

NR . A MP-6690

30x120 . 12"x48"

NR . A MP-6710

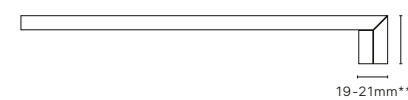

step extra thick corner . nez de marche forte épaisseur angle  
ecke massive stufenplatte . degrau espessurado canto

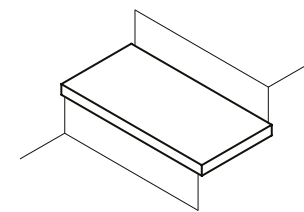

right corner . angle droit  
rechten ecke . canto direito

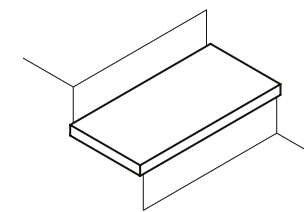

left corner . angle gauche  
links ecke . canto esquerdo



step extra thick corner inox . nez de marche forte épaisseur angle inox  
ecke massive stufenplatte inox . degrau espessurado canto inox

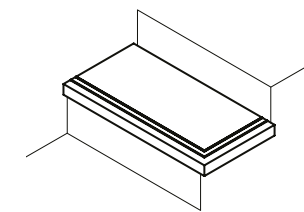

right corner . angle droit  
rechten ecke . canto direito

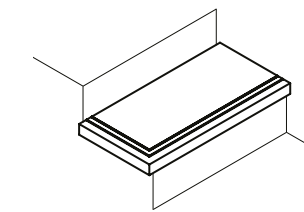

left corner . angle gauche  
links ecke . canto esquerdo

Available in all colours  
Disponibile dans toutes les couleurs  
Erhältlich in allen Farben  
Disponível em todas as cores

\*Available in right and left corner  
\*Disponibile dans les coin droit et gauche  
\*Erhältlich in der rechten Ecke und links  
\*Disponível no canto direito e esquerdo

\*\* Dimension will vary depending on the base tile thickness.  
\*\* La dimension varie selon l'épaisseur du carreau.  
\*\* das Maß variiert je nach Dicke der Fliese.  
\*\* A dimensão varia consoante a espessura do material cerâmico.

\*Decorative pieces with precious metals are sensitive to acid attacks.  
\*Les pièces décoratives en métaux précieux sont sensibles aux attaques d'acides.  
\*Dekorative teile mit Edelmetallen sind gegen Säure empfindlich.  
\*Peças decorativas com metais preciosos são sensíveis aos ataques ácidos.

**MARGRES**  
CERAMIC TILES

index

colour map

collections

concept

edge

endless

evoke

extreme

grove

hybrid

jungle

natural

prestige

pure stone

slabstone

subway

tecnica

time 2.0

tool

underground

linea collections

useful information





58

general catalogue . 2023

light grey HB3 90x90 NR

← Stockwell

↑ Acton Square · Parking

- Stockwell
- Atlantic
- Brent Station
- Tremont
- Castle Hill
- Avenue North
- Avenue South
- Nostrand
- Upton Park
- **Acton Square**
- Oakwood
- Preston Road
- Harrow

TECHNICAL  
FULL BODY  
PORCELAIN

hybrid  
collection

↓  
DOWNLOAD  
CATALOGUE

↓  
DOWNLOAD  
TECHNICAL  
FEATURES

🌐  
VIEW  
ONLINE

▶  
ENJOY THE  
VIDEO



60x120  
NR 11mm  
TC 11mm  
ASR 11mm



90x90  
NR 11mm  
TC 11mm  
ASR 11mm



60x60  
NR 10mm  
TC 10mm  
ASR 10mm



30x60  
NR 10mm  
TC 10mm  
ASR 10mm

rectified products . produits rectifiés . rektifizierete produkte . produtos retificados



white  
HB1

beige  
HB2

light grey  
HB3

tortora  
HB4

black  
HB5

UGL V3 R11 R10 🧑🧑🧑🧑



pour plus d'informations, consultez  
<https://evaluation.cstb.fr>

MARGRES  
CERAMIC TILES

59

general catalogue . 2023

index

colour map

collections

concept

edge

endless

evoke

extreme

grove

hybrid

jungle

natural

prestige

pure stone

slabstone

subway

tecnica

time 2.0

tool

underground

linea collections

useful information



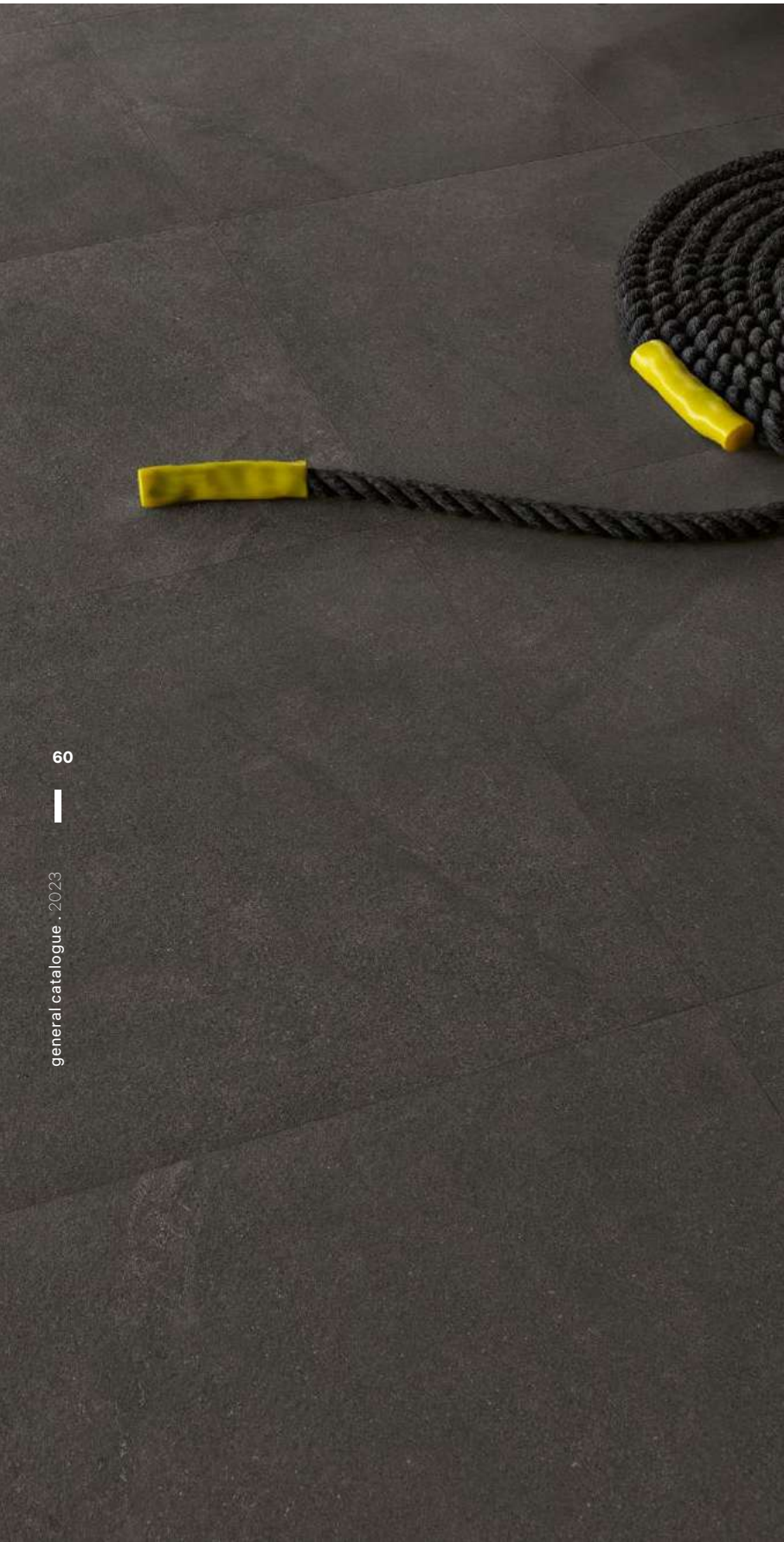





white HB1 60x60 TC



beige HB2 90x90 NR

index

colour map

collections

concept

edge

endless

evoke

extreme

grove

hybrid

jungle

natural

prestige

pure stone

slabstone

subway

tecnica

time 2.0

tool

underground

linea collections

useful information



hybrid  
collection



tortora HB4 90x90 ASR

hybrid  
collection



tortora HB4 60x120 TC

index

colour map

collections

concept

edge

endless

evoke

extreme

grove

**hybrid**

jungle

natural

prestige

pure stone

slabstone

subway

tecnica

time 2.0

tool

underground

linea collections

useful information





30x60 . 12"x24"	10mm	NR	R10	MG-2235
	10mm	TC	-	MG-2235
	10mm	ASR	R11	MG-2235
60x60 . 24"x24"	10mm	NR	R10	MG-2890
	10mm	TC	-	MG-2890
	10mm	ASR	R11	MG-2890
90x90 . 36"x36"	11mm	NR	R10	MG-4100
	11mm	TC	-	MG-4100
	11mm	ASR	R11	MG-4100
60x120 . 24"x48"	11mm	NR	R10	MG-4790
	11mm	TC	-	MG-4790
	11mm	ASR	R11	MG-4790



30x60 . 12"x24"	10mm	NR	R10	MG-2125
	10mm	TC	-	MG-2125
	10mm	ASR	R11	MG-2125
60x60 . 24"x24"	10mm	NR	R10	MG-2810
	10mm	TC	-	MG-2810
	10mm	ASR	R11	MG-2810
90x90 . 36"x36"	11mm	NR	R10	MG-4055
	11mm	TC	-	MG-4055
	11mm	ASR	R11	MG-4055
60x120 . 24"x48"	11mm	NR	R10	MG-4720
	11mm	TC	-	MG-4720
	11mm	ASR	R11	MG-4720



30x60 . 12"x24"	10mm	NR	R10	MG-2125
	10mm	TC	-	MG-2125
	10mm	ASR	R11	MG-2125
60x60 . 24"x24"	10mm	NR	R10	MG-2810
	10mm	TC	-	MG-2810
	10mm	ASR	R11	MG-2810
90x90 . 36"x36"	11mm	NR	R10	MG-4055
	11mm	TC	-	MG-4055
	11mm	ASR	R11	MG-4055
60x120 . 24"x48"	11mm	NR	R10	MG-4720
	11mm	TC	-	MG-4720
	11mm	ASR	R11	MG-4720

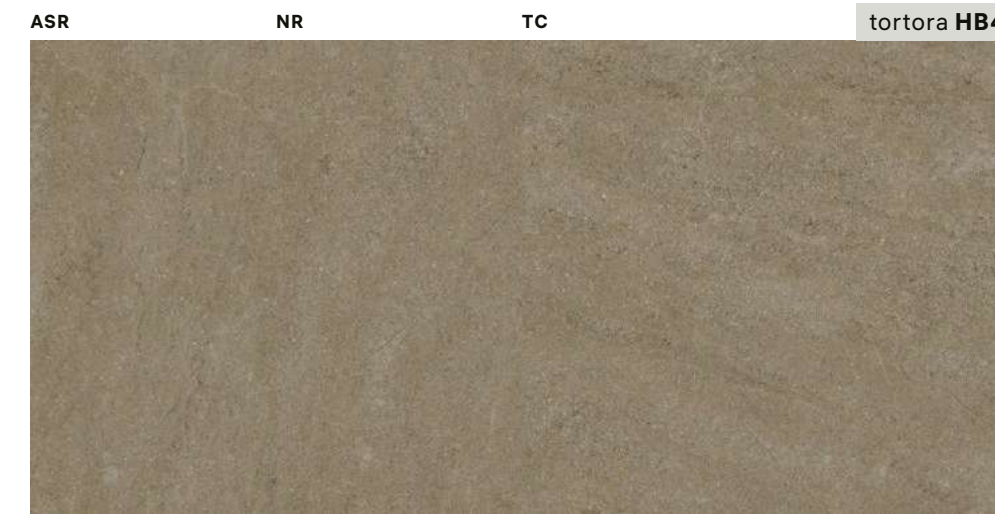

30x60 . 12"x24"	10mm	NR	R10	MG-2125
	10mm	TC	-	MG-2125
	10mm	ASR	R11	MG-2125
60x60 . 24"x24"	10mm	NR	R10	MG-2810
	10mm	TC	-	MG-2810
	10mm	ASR	R11	MG-2810
90x90 . 36"x36"	11mm	NR	R10	MG-4055
	11mm	TC	-	MG-4055
	11mm	ASR	R11	MG-4055
60x120 . 24"x48"	11mm	NR	R10	MG-4720
	11mm	TC	-	MG-4720
	11mm	ASR	R11	MG-4720

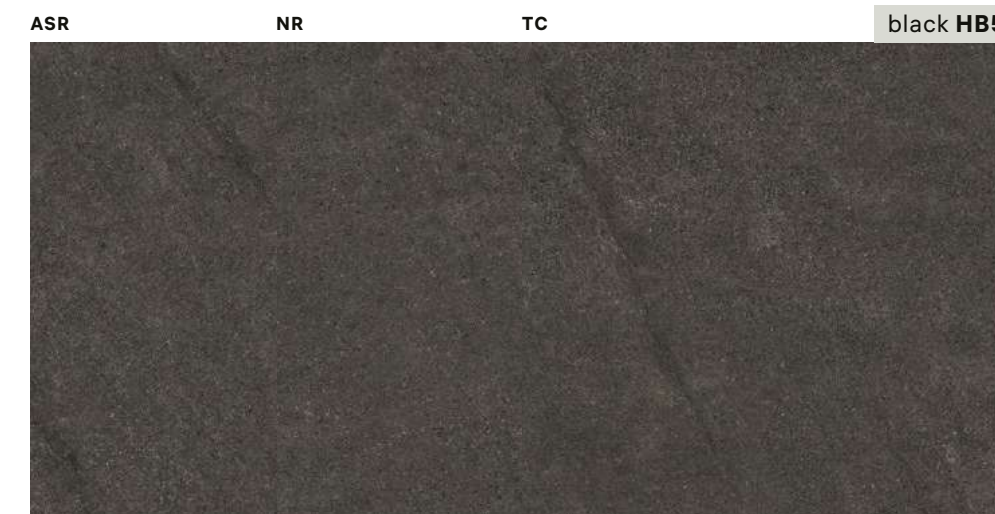

30x60 . 12"x24"	10mm	NR	R10	MG-2125
	10mm	TC	-	MG-2125
	10mm	ASR	R11	MG-2125
60x60 . 24"x24"	10mm	NR	R10	MG-2810
	10mm	TC	-	MG-2810
	10mm	ASR	R11	MG-2810
90x90 . 36"x36"	11mm	NR	R10	MG-4055
	11mm	TC	-	MG-4055
	11mm	ASR	R11	MG-4055
60x120 . 24"x48"	11mm	NR	R10	MG-4720
	11mm	TC	-	MG-4720
	11mm	ASR	R11	MG-4720



**hybrid**  
collection

**decors**

décorations . dekorationen . decorações

10MM



mosaic hybrid 5x5 white  
**30x30** . 12"x12"  
TC MG-9570



mosaic hybrid 5x5 beige  
**30x30** . 12"x12"  
TC MG-9570

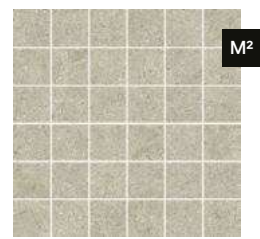

mosaic hybrid 5x5 light grey  
**30x30** . 12"x12"  
TC MG-9570



mosaic hybrid 5x5 tortora  
**30x30** . 12"x12"  
TC MG-9570

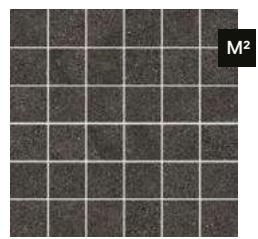

mosaic hybrid 5x5 black  
**30x30** . 12"x12"  
TC MG-9570

10MM



bricks hybrid white  
**30x48** . 12"x19"  
TC MP-6320



bricks hybrid beige  
**30x48** . 12"x19"  
TC MP-6320



bricks hybrid light grey  
**30x48** . 12"x19"  
TC MP-6320



bricks hybrid tortora  
**30x48** . 12"x19"  
TC MP-6320

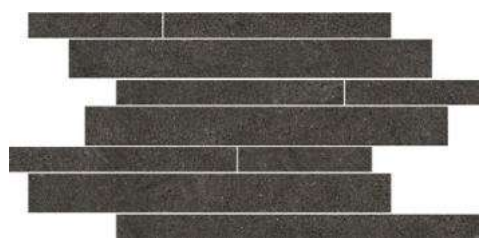

bricks hybrid black  
**30x48** . 12"x19"  
TC MP-6320

**special pieces**

pièces spéciales . spezialteile . peças especiais

11. 10MM

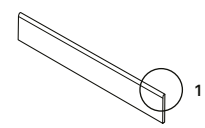

skirting  
plinthe  
sockel  
rodapé boleado

**8x60** . 3,2"x24"  
NR . TC MP-6170  
**8x90** . 3,2"x36"  
NR . TC MP-6260  
**8x120** . 3,2"x48"  
NR . TC MP-6260

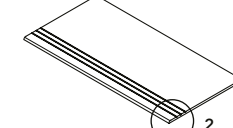
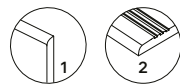

step tread grooved  
nez de marche creusé  
stufenplatte mit rillen  
degrau sulcado

**30x60** . 12"x24"  
NR . TC . ASR MP-6240  
**30x90** . 12"x36"  
NR . TC . ASR MP-6430  
**30x120** . 12"x48"  
NR . TC . ASR MP-6445

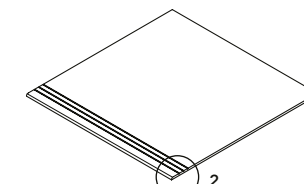

step tread grooved  
nez de marche creusé  
stufenplatte mit rillen  
degrau sulcado

**60x60** . 24"x24"  
NR . TC . ASR MP-6400

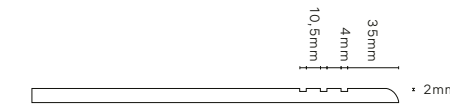

11. 10MM

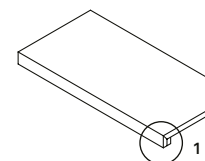

step extra thick  
nez de marche forte épaisseur  
massive stufenplatte  
degrau espessurado

**30x60** . 12"x24"  
NR . TC MP-6560  
**30x120** . 12"x48"  
NR . TC MP-6650

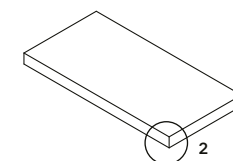
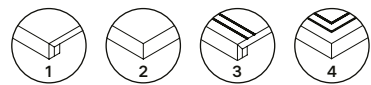

step extra thick corner\*  
nez de marche forte épaisseur angle\*  
ecke massive stufenplatte\*  
degrau espessurado canto\*

**30x60** . 12"x24"  
NR . TC MP-6630  
**30x120** . 12"x48"  
NR . TC MP-6690

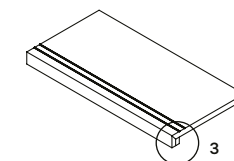

step extra thick inox  
nez de marche forte épaisseur inox  
massive stufenplatte inox  
degrau espessurado inox

**30x60** . 12"x24"  
NR . TC MP-6580  
**30x120** . 12"x48"  
NR . TC MP-6670

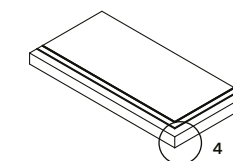

step extra thick corner inox\*  
nez de marche forte épaisseur angle inox\*  
ecke massive stufenplatte inox\*  
degrau espessurado canto inox\*

**30x60** . 12"x24"  
NR . TC MP-6650  
**30x120** . 12"x48"  
NR . TC MP-6710

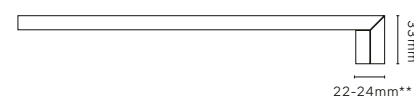

step extra thick corner . nez de marche forte épaisseur angle  
ecke massive stufenplatte . degrau espessurado canto

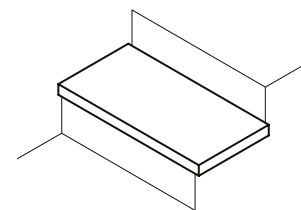

right corner . angle droit  
rechten ecke . canto direito

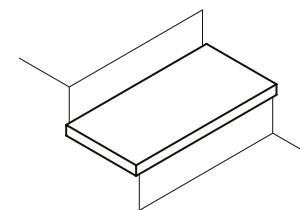

left corner . angle gauche  
links ecke . canto esquerdo



step extra thick corner inox . nez de marche forte épaisseur angle inox  
ecke massive stufenplatte inox . degrau espessurado canto inox

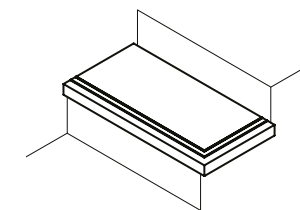

right corner . angle droit  
rechten ecke . canto direito

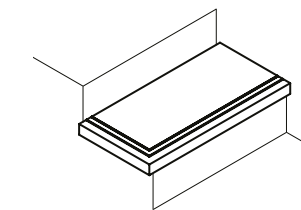

left corner . angle gauche  
links ecke . canto esquerdo

Mosaic and Brick decors are net mounted. All decors may feature shade variations regarding the corresponding floor/wall tile standard tile.  
Les décorations Mosaic et Brick sont sur trame. Toutes les décorations peuvent souffrir variations de tonalité par rapport aux carreaux base.  
Die Mosaic und Brick Dekoration liegen auf einem Netz. Alle Dekorationen können im Vergleich zu den jeweiligen Grundiesen Farbunterschiede aufweisen.  
As decorações Mosaic and Brick são sobre rede. Todas as decorações podem sofrer variações de tonalidade em relação aos respectivos mosaicos base.

**MARGRES**  
CERAMIC TILES

Available in all colours  
Disponible dans toutes les couleurs  
Erhältlich in allen Farben  
Disponível em todas as cores

\*Available in right and left corner  
\*Disponible dans les coin droit et gauche  
\*Erhältlich in der rechten Ecke und links  
\*Disponível no canto direito e esquerdo

\*\* Dimension will vary depending on the base tile thickness.  
\*\* La dimension varie selon l'épaisseur du carreau.  
\*\* das Maß variiert je nach Dicke der Fliese.  
\*\* A dimensão varia consoante a espessura do material cerâmico.

index

colour map

collections

concept

edge

endless

evoke

extreme

grove

hybrid

jungle

natural

prestige

pure stone

slabstone

subway

tecnica

time 2.0

tool

underground

linea collections

useful information











light grey EV3 60x120 NR . 60x60 NR

FULL BODY  
PORCELAIN

**evoke**  
collection

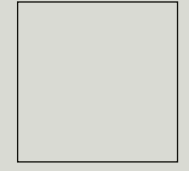
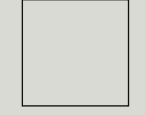
-   
 DOWNLOAD  
CATALOGUE
-   
 DOWNLOAD  
TECHNICAL  
FEATURES
-   
 VIEW  
ONLINE
-   
 DOWNLOAD  
CATALOGUE  
OUTDOOR  
EXTRA THICK

 <b>60x120</b> NR 9,5mm TC 9,5mm E ASR 20mm	 <b>90x90</b> NR 9,5mm TC 9,5mm E ASR 20mm	 <b>60x60</b> NR 8,5mm TC 8,5mm ASR 8,5mm	 <b>30x60</b> NR 8,5mm
--	---	--	---

rectified products . produits rectifiés . rektifizierte produkte . produtos retificados



white EV1      beige EV2      light grey EV3      grey EV4

UGL V3 R11 R10 



pour plus d'informations, consultez  
<https://evaluation.cstb.fr>

**MARGRES**  
CERAMIC TILES

index

colour map

collections

concept

edge

endless

evoke

extreme

grove

hybrid

jungle

natural

prestige

pure stone

slabstone

subway

tecnica

time 2.0

tool

underground

linea collections

useful information













beige EV2 60x60 ASR

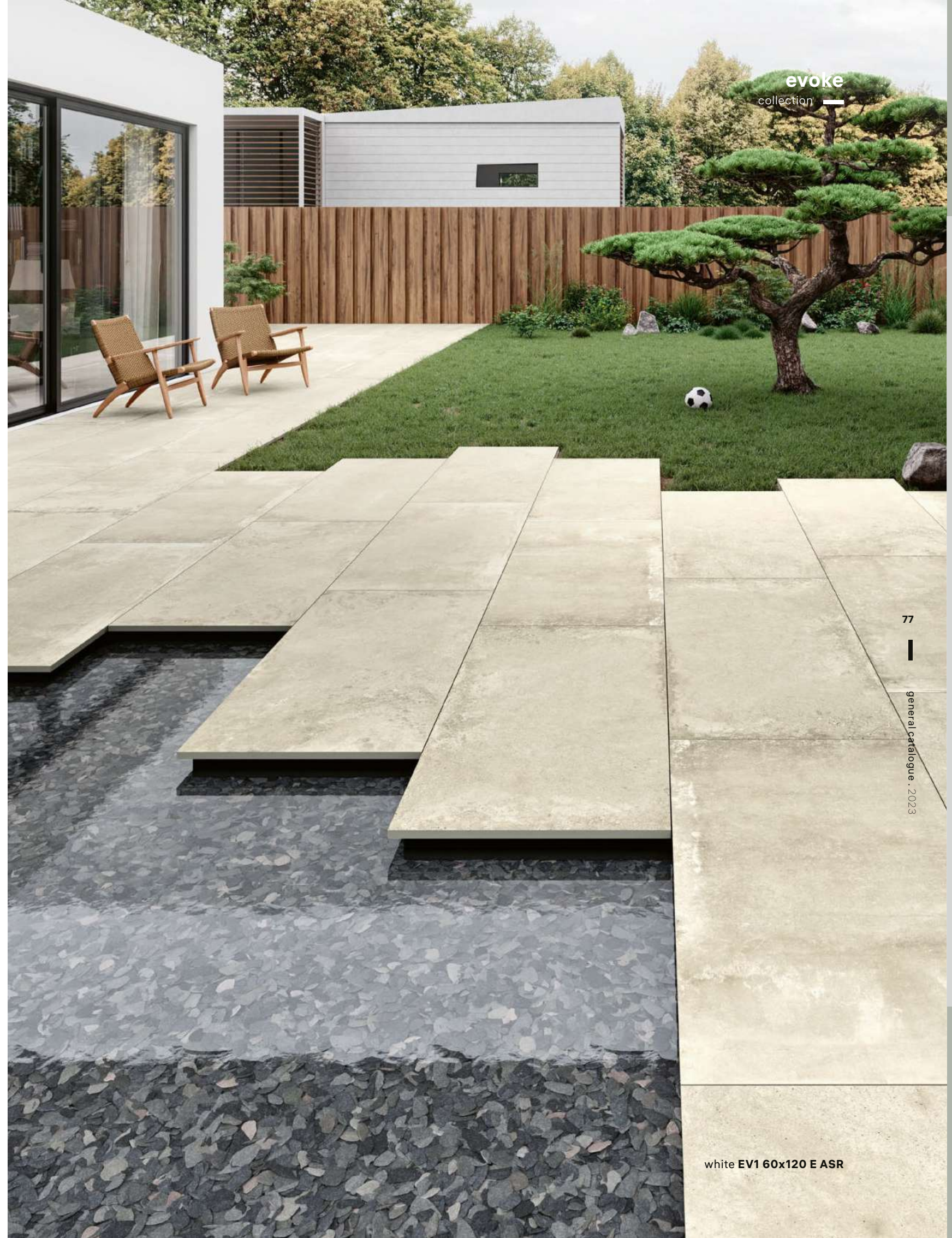

white EV1 60x120 E ASR

index

colour map

collections

concept

edge

endless

evoke

extreme

grove

hybrid

jungle

natural

prestige

pure stone

slabstone

subway

tecnica

time 2.0

tool

underground

linea collections

useful information



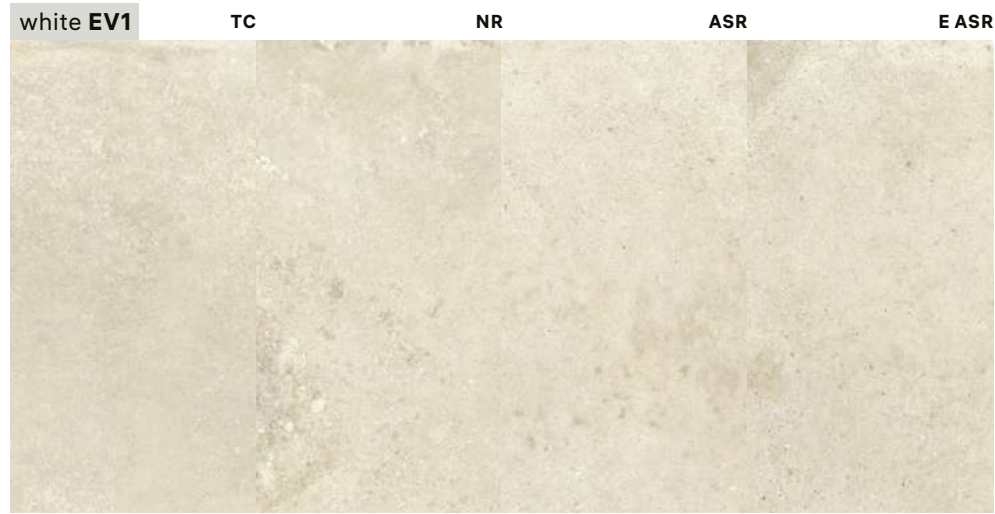

<b>30x60</b> . 12"x24"	8,5mm	<b>NR</b>	R10	MG-2095
	8,5mm	<b>NR</b>	R10	MG-2765
<b>60x60</b> . 24"x24"	8,5mm	<b>TC</b>	-	MG-2765
	8,5mm	<b>ASR</b>	R11	MG-2765
<b>90x90</b> . 36"x36"	9,5mm	<b>NR</b>	R10	MG-3960
	9,5mm	<b>TC</b>	-	MG-3960
	20mm	<b>E ASR</b>	R11	MG-7690
<b>60x120</b> . 24"x48"	9,5mm	<b>NR</b>	R10	MG-4695
	9,5mm	<b>TC</b>	-	MG-4695
	20mm	<b>E ASR</b>	R11	MG-7490



<b>30x60</b> . 12"x24"	8,5mm	<b>NR</b>	R10	MG-2095
	8,5mm	<b>NR</b>	R10	MG-2765
<b>60x60</b> . 24"x24"	8,5mm	<b>TC</b>	-	MG-2765
	8,5mm	<b>ASR</b>	R11	MG-2765
<b>90x90</b> . 36"x36"	9,5mm	<b>NR</b>	R10	MG-3960
	9,5mm	<b>TC</b>	-	MG-3960
<b>60x120</b> . 24"x48"	9,5mm	<b>NR</b>	R10	MG-4695
	9,5mm	<b>TC</b>	-	MG-4695



<b>30x60</b> . 12"x24"	8,5mm	<b>NR</b>	R10	MG-2095
	8,5mm	<b>NR</b>	R10	MG-2765
<b>60x60</b> . 24"x24"	8,5mm	<b>TC</b>	-	MG-2765
	8,5mm	<b>ASR</b>	R11	MG-2765
<b>90x90</b> . 36"x36"	9,5mm	<b>NR</b>	R10	MG-3960
	9,5mm	<b>TC</b>	-	MG-3960
	20mm	<b>E ASR</b>	R11	MG-7690
<b>60x120</b> . 24"x48"	9,5mm	<b>NR</b>	R10	MG-4695
	9,5mm	<b>TC</b>	-	MG-4695
	20mm	<b>E ASR</b>	R11	MG-7490

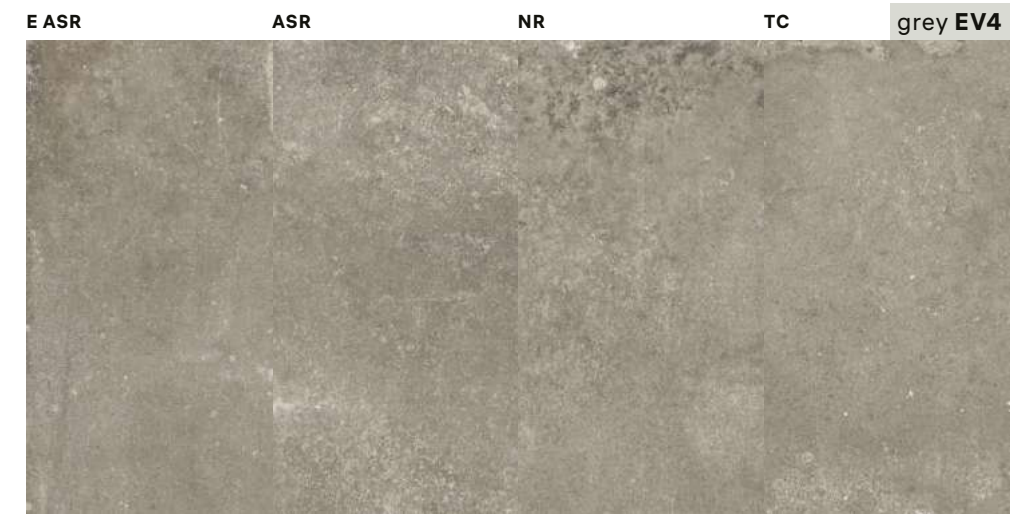

<b>30x60</b> . 12"x24"	8,5mm	<b>NR</b>	R10	MG-2095
	8,5mm	<b>NR</b>	R10	MG-2765
<b>60x60</b> . 24"x24"	8,5mm	<b>TC</b>	-	MG-2765
	8,5mm	<b>ASR</b>	R11	MG-2765
<b>90x90</b> . 36"x36"	9,5mm	<b>NR</b>	R10	MG-3960
	9,5mm	<b>TC</b>	-	MG-3960
	20mm	<b>E ASR</b>	R11	MG-7690
<b>60x120</b> . 24"x48"	9,5mm	<b>NR</b>	R10	MG-4695
	9,5mm	<b>TC</b>	-	MG-4695
	20mm	<b>E ASR</b>	R11	MG-7490



**decors**

décorations . dekorationen . decorações

8,5MM



mosaic evoke 5x5 white  
**30x30** . 12"x12"  
NR MG-9640



mosaic evoke 5x5 beige  
**30x30** . 12"x12"  
NR MG-9640



mosaic evoke 5x5 light grey  
**30x30** . 12"x12"  
NR MG-9640

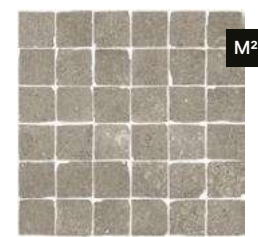

mosaic evoke 5x5 grey  
**30x30** . 12"x12"  
NR MG-9640

8,5MM



bricks evoke white  
**30x30** . 12"x12"  
TC MG-9640



bricks evoke beige  
**30x30** . 12"x12"  
TC MG-9640



bricks evoke light grey  
**30x30** . 12"x12"  
TC MG-9640



bricks evoke grey  
**30x30** . 12"x12"  
TC MG-9640

**special pieces**

pièces spéciales . spezialteile . peças especiais

9,5 . 8,5MM

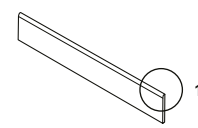

skirting  
plinthe  
sockel  
rodapé boleado

**8x60** . 3,2"x24"  
NR . TC MP-6170  
**8x90** . 3,2"x36"  
NR . TC MP-6260  
**8x120** . 3,2"x48"  
NR . TC MP-6260

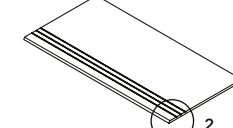
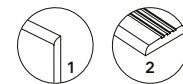

step tread grooved  
nez de marche creusé  
stufenplatte mit rillen  
degrau sulcado

**30x60** . 12"x24"  
NR . TC . ASR MP-6240  
**30x90** . 12"x36"  
NR . TC MP-6430  
**30x120** . 12"x48"  
NR . TC MP-6445

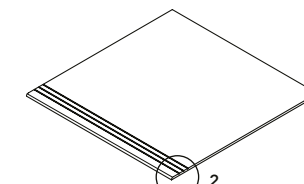

step tread grooved  
nez de marche creusé  
stufenplatte mit rillen  
degrau sulcado

**60x60** . 24"x24"  
NR . TC . ASR MP-6400

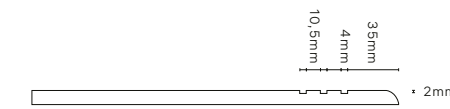

9,5 . 8,5MM

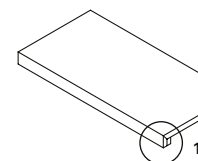

step extra thick  
nez de marche forte épaisseur  
massive stufenplatte  
degrau espessurado

**30x60** . 12"x24"  
NR . TC MP-6560  
**30x120** . 12"x48"  
NR . TC MP-6650

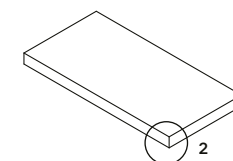
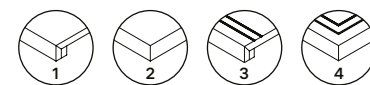

step extra thick corner\*  
nez de marche forte épaisseur angle\*  
ecke massive stufenplatte\*  
degrau espessurado canto\*

**30x60** . 12"x24"  
NR . TC MP-6630  
**30x120** . 12"x48"  
NR . TC MP-6690

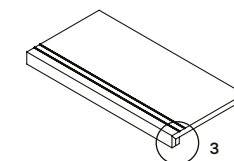

step extra thick inox  
nez de marche forte épaisseur inox  
massive stufenplatte inox  
degrau espessurado inox

**30x60** . 12"x24"  
NR . TC MP-6580  
**30x120** . 12"x48"  
NR . TC MP-6670

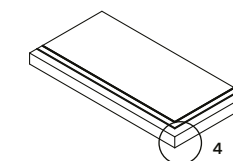

step extra thick corner inox\*  
nez de marche forte épaisseur angle inox\*  
ecke massive stufenplatte inox\*  
degrau espessurado canto inox\*

**30x60** . 12"x24"  
NR . TC MP-6650  
**30x120** . 12"x48"  
NR . TC MP-6710

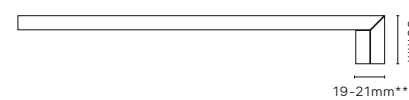

step extra thick corner . nez de marche forte épaisseur angle  
ecke massive stufenplatte . degrau espessurado canto

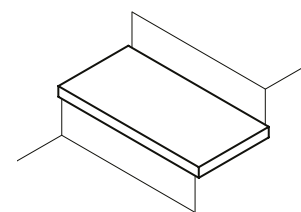

right corner . angle droit  
rechten ecke . canto direito

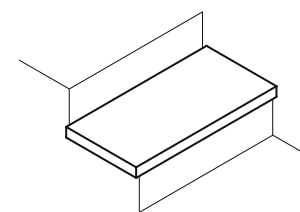

left corner . angle gauche  
links ecke . canto esquerdo



step extra thick corner inox . nez de marche forte épaisseur angle inox  
ecke massive stufenplatte inox . degrau espessurado canto inox

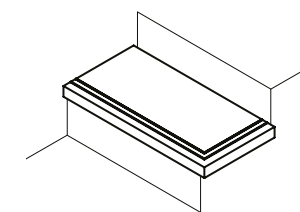

right corner . angle droit  
rechten ecke . canto direito

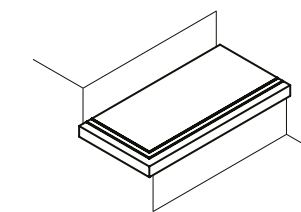

left corner . angle gauche  
links ecke . canto esquerdo

Mosaic and Brick decors are net mounted. All decors may feature shade variations regarding the corresponding floor/wall tile standard tile.  
Les décorations Mosaic et Brick sont sur trame. Toutes les décorations peuvent souffrir variations de tonalité par rapport aux carreaux base.  
Die Mosaic und Brick Dekoration liegen auf einem Netz. Alle Dekorationen können im Vergleich zu den jeweiligen Grundiesen Farbunterschiede aufweisen.  
As decorações Mosaic and Brick são sobre rede. Todas as decorações podem sofrer variações de tonalidade em relação aos respectivos mosaicos base.

Available in all colours  
Disponible dans toutes les couleurs  
Erhältlich in allen Farben  
Disponível em todas as cores

\*Available in right and left corner  
\*Disponible dans les coin droit et gauche  
\*Erhältlich in der rechten Ecke und links  
\*Disponível no canto direito e esquerdo

\*\* Dimension will vary depending on the base tile thickness.  
\*\* La dimension varie selon l'épaisseur du carreau.  
\*\* das Maß variiert je nach Dicke der Fliese.  
\*\* A dimensão varia consoante a espessura do material cerâmico.





brown JU2 20x120 N

DIGITEK  
PORCELAIN  
STONEWARE

# jungle

collection

↓  
DOWNLOAD  
CATALOGUE

↓  
DOWNLOAD  
TECHNICAL  
FEATURES

↓  
VIEW  
ONLINE

↓  
DOWNLOAD  
CATALOGUE  
OUTDOOR  
EXTRA THICK



40x120  
E ASR 20mm



20x120  
N 8mm  
NR 8mm  
AS 8mm

N . AS non-rectified products . produits non rectifiés . nicht rektifizierte produkte . produtos não retificados  
NR . E ASR rectified products . produits rectifiés . rektifizierte produkte . produtos retificados



beige  
JU1

brown  
JU2

grey  
JU3

UGL V4 R11 R10



pour plus d'informations, consultez  
<https://evaluation.cstb.fr>

**MARGRES**  
CERAMIC TILES

index

colour map

collections

concept

edge

endless

evoke

extreme

grove

hybrid

jungle

natural

prestige

pure stone

slabstone

subway

tecnica

time 2.0

tool

underground

linea collections

useful information





index

colour map

collections

concept

edge

endless

evoke

extreme

grove

hybrid

jungle

natural

prestige

pure stone

slabstone

subway

tecnica

time 2.0

tool

underground

linea collections

useful information





86

general catalogue . 2023

87

general catalogue

brown JU2 20x120 AS . white CT1 60x120 NR



jungle  
collection

jungle  
collection

index

colour map

collections

concept

edge

endless

evoke

extreme

grove

hybrid

jungle

natural

prestige

pure stone

slabstone

subway

tecnica

time 2.0

tool

underground

linea collections

useful information

88

general catalogue . 2023

89

© 2023 F.lli. Cazzani

beige JU1 40x120 F ASR





green cases.  
his hand will remain  
like the  
to the car.

**jungle**  
collection

90

general catalogue . 2023

beige JU1 20x120 N

**jungle**  
collection

index

colour map

collections

concept

edge

endless

evoke

extreme

grove

hybrid

**jungle**

natural

prestige

pure stone

slabstone

subway

tecnica

time 2.0

tool

underground

linea collections

useful information

20x120 . 8"x48"	8mm	<b>N</b>	R10	MG-1230
	8mm	<b>NR</b>	R10	MG-1340
	8mm	<b>AS</b>	R11	MG-1255
40x120 . 16"x48"	20mm	<b>E ASR</b>	R11	MG-7290

20x120 . 8"x48"	8mm	<b>N</b>	R10	MG-1230
	8mm	<b>NR</b>	R10	MG-1340
	8mm	<b>AS</b>	R11	MG-1255

20x120 . 8"x48"	8mm	<b>N</b>	R10	MG-1230
	8mm	<b>NR</b>	R10	MG-1340
	8mm	<b>AS</b>	R11	MG-1255

Pictures represent a random pattern based on five 20x120 tiles.  
Les images représentent le modèle aléatoire de cinq carreaux 20x120.  
Die Bilder repräsentieren das zufällige Muster von fünf 20x120 Stücke.  
As imagens representam o padrão aleatório de cinco peças 20x120.

**laying suggestions**

suggestions de pose . anwendungsvorschläge . sugestões de aplicação

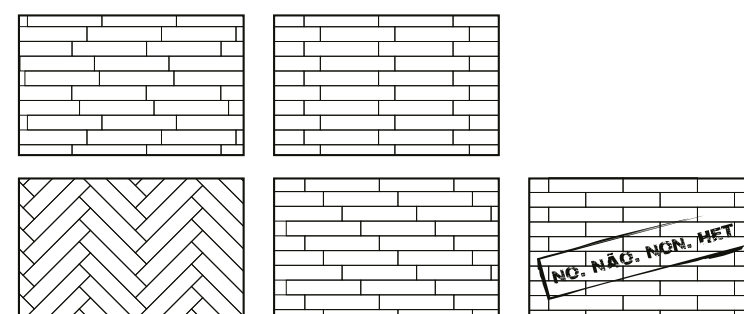

**special pieces**

pièces spéciales . spezialteile . peças especiais

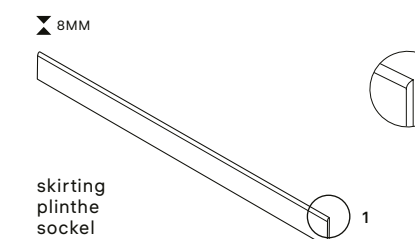

skirting  
plinthe  
sockel  
rodapé boleado

**8x120** . 3,2"x 48"  
**N** MP-6200  
**NR** MP-6260

Available in all colours  
Disponible dans toutes les couleurs  
Erhältlich in allen Farben  
Disponível em todas as cores

91

general catalogue . 2023





calacatta PT1 60x120 NR . 60x60 P

LAMINATED  
PORCELAIN  
STONEWARE

DIGITEK  
PORCELAIN  
STONEWARE

**prestige**  
collection



100x300  
NR . P 5,5mm

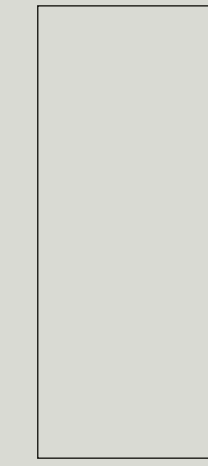

100x250  
NR . P 5,5mm

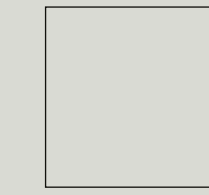

100x100  
NR . P . ASR 5,5mm



50x100  
NR . P 5,5mm

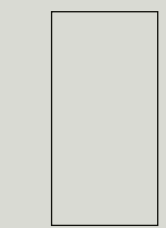

60x120  
NR . P 9,5mm

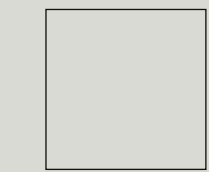

90x90 . 89x89  
NR P 9,5mm

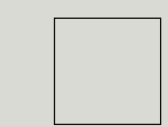

60x60  
NR . P 8,5mm

↓  
DOWNLOAD  
CATALOGUE

↓  
DOWNLOAD  
TECHNICAL  
FEATURES

🌐  
VIEW  
ONLINE

rectified products . produits rectifiés . rektifizierete produkte . produtos retificados



calacatta  
PT1 . LPT1

corinthian  
beige  
PT2 . LPT2

travertino  
grey  
PT3 . LPT3

fior di bosco  
tortora  
PT4 . LPT4

emperador  
black  
PT5 . LPT5

UGL V2 R10  
NR . ASR P

**PROTECT**  
Antibacterial for Life.

**MARGRES**  
CERAMIC TILES

index

colour map

collections

concept

edge

endless

evoke

extreme

grove

hybrid

jungle

natural

prestige

pure stone

slabstone

subway

tecnica

time 2.0

tool

underground

linea collections

useful information



prestige  
collection

prestige  
collection

index

colour map

collections

concept

edge

endless

evoke

extreme

grove

hybrid

jungle

natural

prestige

pure stone

slabstone

subway

tecnica

time 2.0

tool

underground

linea collections

useful information

94

general catalogue . 2023

95

general catalogue . 2023

corinthian beige PT2 89x89 P





96

general catalogue . 2023



97

general catalogue . 2023







index

colour map

collections

concept

edge

endless

evoke

extreme

grove

hybrid

jungle

natural

**prestige**

pure stone

slabstone

subway

tecnica

time 2.0

tool

underground

linea collections

useful information



calacatta PT1 . LPT1 P NR ASR



60x60 . 24"x24"	8,5mm	NR	-	MG-2775
	8,5mm	P	-	MG-3280
89x89 . 35"x35"	9,5mm	P	-	MG-4470
90x90 . 36"x36"	9,5mm	NR	-	MG-3955
60x120 . 24"x48"	9,5mm	NR	-	MG-4680
	9,5mm	P	-	MG-5160

LINEA

50x100 . 19,6"x39,4"	5,5mm	NR	-	M3-1930
	5,5mm	P	-	M3-2330
	5,5mm	ASR	R10	M3-2730
100x100 . 39,4"x39,4"	5,5mm	NR	-	M3-2730
	5,5mm	P	-	M3-3130
100x250 . 39,4"x98,4"	5,5mm	NR	-	M3-3530
	5,5mm	P	-	M3-3830
100x300 . 39,4"x118"	5,5mm	NR	-	M3-4230
	5,5mm	P	-	M3-4630

corinthian beige PT2 . LPT2 P NR



60x60 . 24"x24"	8,5mm	NR	-	MG-2775
	8,5mm	P	-	MG-3280
89x89 . 35"x35"	9,5mm	P	-	MG-4470
90x90 . 36"x36"	9,5mm	NR	-	MG-3955
60x120 . 24"x48"	9,5mm	NR	-	MG-4680
	9,5mm	P	-	MG-5160

LINEA

50x100 . 19,6"x39,4"	5,5mm	NR	-	M3-1930
	5,5mm	P	-	M3-2330
100x100 . 39,4"x39,4"	5,5mm	NR	-	M3-2730
	5,5mm	P	-	M3-3130
100x250 . 39,4"x98,4"	5,5mm	NR	-	M3-3530
	5,5mm	P	-	M3-3830
100x300 . 39,4"x118"	5,5mm	NR	-	M3-4230
	5,5mm	P	-	M3-4630

travertino grey PT3 . LPT3 P NR



60x60 . 24"x24"	8,5mm	NR	-	MG-2775
	8,5mm	P	-	MG-3280
89x89 . 35"x35"	9,5mm	P	-	MG-4470
90x90 . 36"x36"	9,5mm	NR	-	MG-3955
60x120 . 24"x48"	9,5mm	NR	-	MG-4680
	9,5mm	P	-	MG-5160

LINEA

50x100 . 19,6"x39,4"	5,5mm	NR	-	M3-1930
	5,5mm	P	-	M3-2330
100x100 . 39,4"x39,4"	5,5mm	NR	-	M3-2730
	5,5mm	P	-	M3-3130
100x250 . 39,4"x98,4"	5,5mm	NR	-	M3-3530
	5,5mm	P	-	M3-3830
100x300 . 39,4"x118"	5,5mm	NR	-	M3-4230
	5,5mm	P	-	M3-4630

60x60 . 24"x24"	8,5mm	NR	-	MG-2775
	8,5mm	P	-	MG-3280
89x89 . 35"x35"	9,5mm	P	-	MG-4470
90x90 . 36"x36"	9,5mm	NR	-	MG-3955
60x120 . 24"x48"	9,5mm	NR	-	MG-4680
	9,5mm	P	-	MG-5160

LINEA

50x100 . 19,6"x39,4"	5,5mm	NR	-	M3-1930
	5,5mm	P	-	M3-2330
100x100 . 39,4"x39,4"	5,5mm	NR	-	M3-2730
	5,5mm	P	-	M3-3130
100x250 . 39,4"x98,4"	5,5mm	NR	-	M3-3530
	5,5mm	P	-	M3-3830
100x300 . 39,4"x118"	5,5mm	NR	-	M3-4230
	5,5mm	P	-	M3-4630

60x60 . 24"x24"	8,5mm	NR	-	MG-2775
	8,5mm	P	-	MG-3280
89x89 . 35"x35"	9,5mm	P	-	MG-4470
90x90 . 36"x36"	9,5mm	NR	-	MG-3955
60x120 . 24"x48"	9,5mm	NR	-	MG-4680
	9,5mm	P	-	MG-5160

LINEA

50x100 . 19,6"x39,4"	5,5mm	NR	-	M3-1930
	5,5mm	P	-	M3-2330
100x100 . 39,4"x39,4"	5,5mm	NR	-	M3-2730
	5,5mm	P	-	M3-3130
100x250 . 39,4"x98,4"	5,5mm	NR	-	M3-3530
	5,5mm	P	-	M3-3830
100x300 . 39,4"x118"	5,5mm	NR	-	M3-4230
	5,5mm	P	-	M3-4630

NR P fior di bosco tortora PT4 . LPT4



NR P emperador black PT5 . LPT5



Products with a polished finish are more sensitive to abrasion and stains, what requires special conditions. Please see page 348 in chapter 09.  
Les produits à finition polie sont plus sensibles à l'abrasion et aux taches, ce qui requiert des conditions particulières. Veuillez-vous consulter la page 348 du chapitre 09.  
Produkte mit einer polierten Oberfläche sind empfindlicher gegen Abrieb und Fleckenbildung, was besondere Bedingungen erfordert. Bitte beachten Sie Seite 348 in Kapitel 09.  
Os produtos com acabamento polido são mais sensíveis à abrasão e às manchas, o que requer condições especiais. Por favor consulte a página 348 no capítulo 09.

PROTECT®

Antibacterial for Life.

An exclusive line of extremely high performance antimicrobial floor and wall tiles, designed for healthy, safe and protected living spaces. Available only in Linea Range and in natural rectified and polished finishes.  
Une ligne exclusive de sols et revêtements antibactériens aux performances très élevées, pour un habitat sain, sûr et protégé. Disponible uniquement dans la gamme Linea et dans les finitions naturel rectifié et poli.  
Eine exklusive Linie an hochwertigen Fußböden und antibakteriellen Wandverkleidungen, für ein gesundes, sicheres und geschütztes Leben. Nur in der Linea Serie erhältlich und auf rektifiziert naturbelassen und poliert.  
Uma linha exclusiva de pavimentos e revestimentos antimicrobianos de altíssima performance, projetada para ambientes saudáveis, seguros e protegidos. Disponível unicamente na gama Linea e nos acabamentos natural retificado e polido.



decors

décorations . dekorationen . decorações

8,5MM



mosaic prestige 4,4x5  
(all colours)  
**30x30** . 12"x12"  
NR MG-9580  
P MG-9830

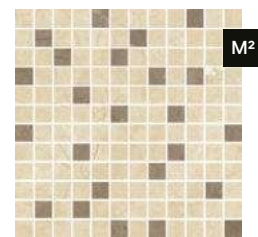

mosaic 2,3x2,3  
summer spot  
**30x30** . 12"x12"  
NR MG-9640  
P MG-9885



mosaic 2,3x2,3  
winter spot  
**30x30** . 12"x12"  
NR MG-9640  
P MG-9885



bricks prestige  
(all colours)  
**29,6x59,5** . 11,7"x23,4"  
NR MP-6310  
P MP-6330

8,5MM



mosaic shell  
fior di bosco tortora  
**31x33** . 12"x13"  
NR MP-6370  
P MP-6380



mosaic shell  
travertino grey  
**31x33** . 12"x13"  
NR MP-6370  
P MP-6380



mosaic shell  
emperador black  
**31x33** . 12"x13"  
NR MP-6370  
P MP-6380

8,5MM

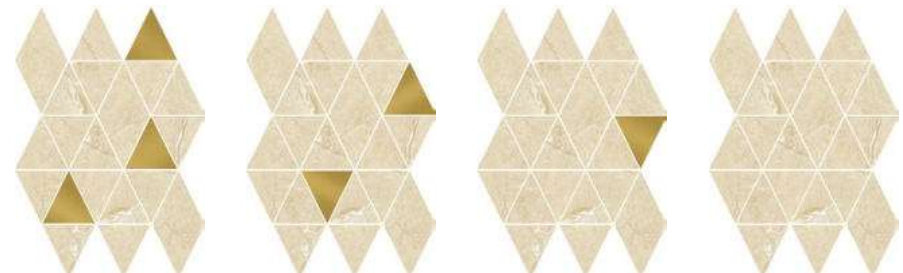

mosaic sharp\* (all colours)  
**22x28,5** . 8,7"x11,2"  
NR MP-6330  
P MP-6350

Mosaic and Brick decors are net mounted. All decors may feature shade variations regarding the corresponding floor/wall tile standard tile.

Les décorations Mosaic et Brick sont sur trame. Toutes les décorations peuvent souffrir variations de tonalité par rapport aux carreaux base.

Die Mosaic und Brick Dekoration liegen auf einem Netz. Alle Dekorationen können im Vergleich zu den jeweiligen Grundiesen Farbunterschiede aufweisen.

As decorações Mosaic and Brick são sobre rede. Todas as decorações podem sofrer variações de tonalidade em relação aos respectivos mosaicos base.

\* Decoration available in 4 different patterns, sold randomly. Please see page 97. Decorative pieces with precious metals are sensitive to acid attacks and must not be used for floors.

\* Décoration avec 4 pièces différentes et vendues de façon aléatoire. Veuillez s'il vous plaît consulter la page 97. Les pièces décoratives en métaux précieux sont sensibles aux attaques d'acides et ne doivent pas être appliqués sur les carrelages.

\* Dekoration in 4 verschiedenen Mustern erhältlich, nach dem Zufallsprinzip verkauft. Bitte sehen Sie Seite 97. Dekorative Teile mit Edelmetallen sind gegen Säure empfindlich und sollten nicht als Bodenbelag zum Einsatz kommen.

\* Decoração com 4 peças diferentes e vendidas aleatoriamente. Por favor, ver a página 97. Peças decorativas com metais preciosos são sensíveis aos ataques ácidos e não devem ser aplicadas em pavimento.

special pieces

pièces spéciales . spezialteile . peças especiais

9,5 . 8,5MM

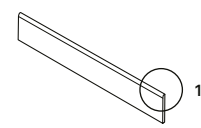

skirting  
plinthe  
socket  
rodapé boleado

**8x60** . 3,2"x24"  
NR MP-6170  
P MP-6180  
**8x89** . 3,2"x35"  
P MP-6270  
**8x90** . 3,2"x36"  
NR MP-6260  
**8x120** . 3,2"x48"  
NR MP-6260  
P MP-6270

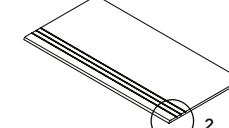
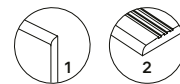

step tread grooved  
nez de marche creusé  
stufenplatte mit rillen  
degrau sulcado

**30x60** . 12"x24"  
NR MP-6240  
P MP-6270  
**30x89** . 12"x35"  
P MP-6445  
**30x90** . 12"x36"  
NR MP-6430  
**30x120** . 12"x48"  
NR MP-6445  
P MP-6470

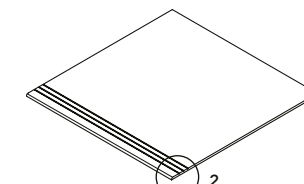

step tread grooved  
nez de marche creusé  
stufenplatte mit rillen  
degrau sulcado

**60x60** . 24"x24"  
NR MP-6400  
P MP-6430

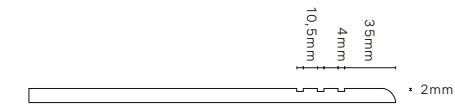

9,5 . 8,5MM

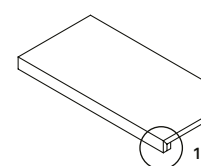

step extra thick  
nez de marche forte épaisseur  
massive stufenplatte  
degrau espessurado

**30x60** . 12"x24"  
NR . P MP-6560  
**30x120** . 12"x48"  
NR . P MP-6650

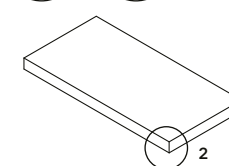
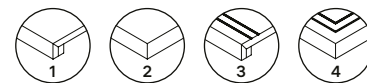

step extra thick corner\*  
nez de marche forte épaisseur angle\*  
ecke massive stufenplatte\*  
degrau espessurado canto\*

**30x60** . 12"x24"  
NR . P MP-6630  
**30x120** . 12"x48"  
NR . P MP-6690

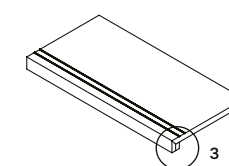

step extra thick inox  
nez de marche forte épaisseur inox  
massive stufenplatte inox  
degrau espessurado inox

**30x60** . 12"x24"  
NR . P MP-6580  
**30x120** . 12"x48"  
NR . P MP-6670

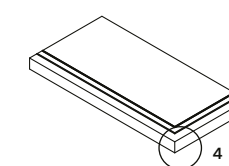

step extra thick corner inox\*  
nez de marche forte épaisseur angle inox\*  
ecke massive stufenplatte inox\*  
degrau espessurado canto inox\*

**30x60** . 12"x24"  
NR . P MP-6650  
**30x120** . 12"x48"  
NR . P MP-6710

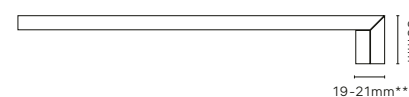

step extra thick corner . nez de marche forte épaisseur angle  
ecke massive stufenplatte . degrau espessurado canto

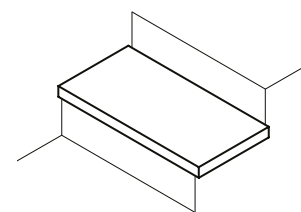

right corner . angle droit  
rechten ecke . canto direito

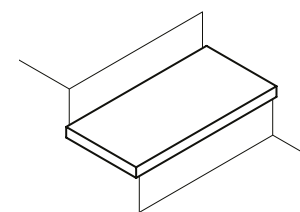

left corner . angle gauche  
links ecke . canto esquerdo

Available in all colours  
Disponible dans toutes les couleurs  
Erhältlich in allen Farben  
Disponível em todas as cores

\*Available in right and left corner  
\*Disponible dans les coin droit et gauche  
\*Erhältlich in der rechten Ecke und links  
\*Disponível no canto direito e esquerdo



step extra thick corner inox . nez de marche forte épaisseur angle inox  
ecke massive stufenplatte inox . degrau espessurado canto inox

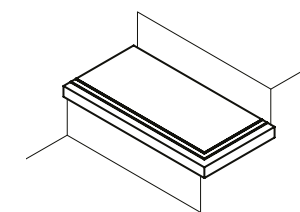

right corner . angle droit  
rechten ecke . canto direito

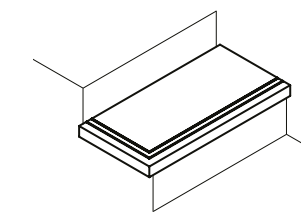

left corner . angle gauche  
links ecke . canto esquerdo

\*\* Dimension will vary depending on the base tile thickness.

\*\* La dimension varie selon l'épaisseur du carreau.

\*\* das Maß variiert je nach Dicke der Fliese.

\*\* A dimensão varia consoante a espessura do material cerâmico.





104

general catalogue . 2023

light grey CT3 60x120 NR

FULL BODY  
PORCELAIN

# concept

collection

↓  
DOWNLOAD  
CATALOGUE

↓  
DOWNLOAD  
TECHNICAL  
FEATURES

🌐  
VIEW  
ONLINE



60x120  
NR 9,5mm  
A 9,5mm



90x90  
NR 9,5mm  
A 9,5mm



45x90  
NR 9mm  
A 9mm  
ASR 9mm

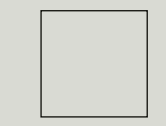

60x60  
NR 8,5mm  
A 8,5mm  
ASR 8,5mm

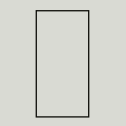

30x60  
NR 8,5mm  
A 8,5mm

rectified products . produits rectifiés . rektifizierter produkte . produtos retificados



white  
CT1

beige  
CT2

light grey  
CT3

grey  
CT4

UGL V3 R11 R10



pour plus d'informations, consultez  
<https://evaluation.cstb.fr>

**MARGRES**  
CERAMIC TILES

105

general catalogue . 2023

index

colour map

collections

concept

edge

endless

evoke

extreme

grove

hybrid

jungle

natural

prestige

pure stone

slabstone

subway

tecnica

time 2.0

tool

underground

linea collections

useful information









108

general catalogue . 2023



109

general catalogue . 2023



white CT1 60x60 A . 30x60 NR





grey CT4 60x60 A

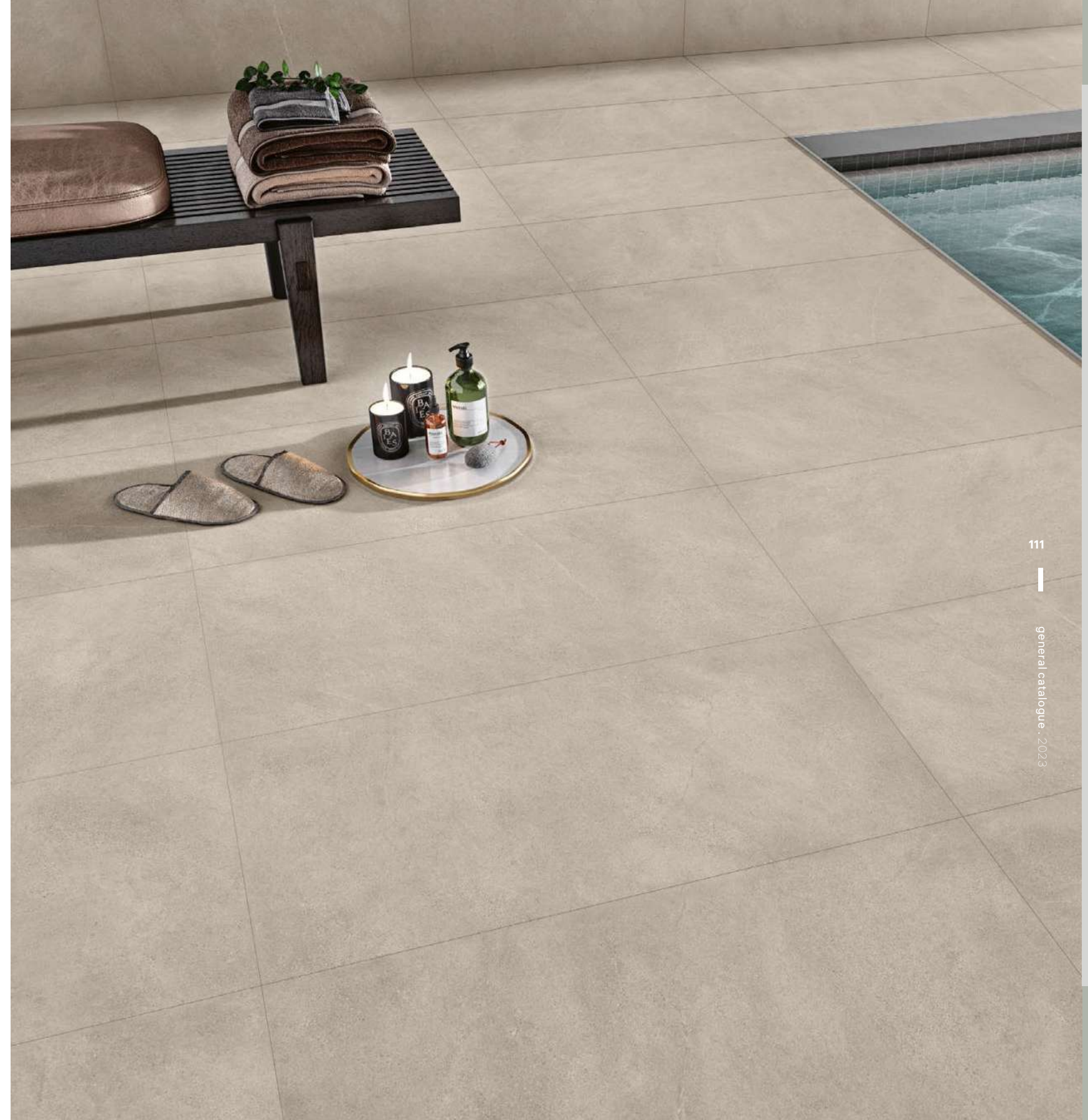

light grey CT3 45x90 NR . 45x90 ASR

index

colour map

collections

concept

edge

endless

evoke

extreme

grove

hybrid

jungle

natural

prestige

pure stone

slabstone

subway

tecnica

time 2.0

tool

underground

linea collections

useful information





30x60 . 12"x24"	8,5mm	<b>NR</b>	R10	MG-2095
	8,5mm	<b>A</b>	-	MG-2370
60x60 . 24"x24"	8,5mm	<b>NR</b>	R10	MG-2765
	8,5mm	<b>A</b>	-	MG-3080
	8,5mm	<b>ASR</b>	R11	MG-2765
45x90 . 18"x36"	9mm	<b>NR</b>	R10	MG-3560
	9mm	<b>A</b>	-	MG-3730
90x90 . 36"x36"	9mm	<b>ASR</b>	R11	MG-3560
	9,5mm	<b>NR</b>	R10	MG-3960
90x90 . 36"x36"	9,5mm	<b>A</b>	-	MG-4290
	9,5mm	<b>NR</b>	R10	MG-4695
60x120 . 24"x48"	9,5mm	<b>A</b>	-	MG-4970



30x60 . 12"x24"	8,5mm	<b>NR</b>	R10	MG-2095
	8,5mm	<b>A</b>	-	MG-2370
60x60 . 24"x24"	8,5mm	<b>NR</b>	R10	MG-2765
	8,5mm	<b>A</b>	-	MG-3080
	8,5mm	<b>ASR</b>	R11	MG-2765
45x90 . 18"x36"	9mm	<b>NR</b>	R10	MG-3560
	9mm	<b>A</b>	-	MG-3730
90x90 . 36"x36"	9mm	<b>ASR</b>	R11	MG-3560
	9,5mm	<b>NR</b>	R10	MG-3960
90x90 . 36"x36"	9,5mm	<b>A</b>	-	MG-4290
	9,5mm	<b>NR</b>	R10	MG-4695
60x120 . 24"x48"	9,5mm	<b>A</b>	-	MG-4970



30x60 . 12"x24"	8,5mm	<b>NR</b>	R10	MG-2095
	8,5mm	<b>A</b>	-	MG-2370
60x60 . 24"x24"	8,5mm	<b>NR</b>	R10	MG-2765
	8,5mm	<b>A</b>	-	MG-3080
	8,5mm	<b>ASR</b>	R11	MG-2765
45x90 . 18"x36"	9mm	<b>NR</b>	R10	MG-3560
	9mm	<b>A</b>	-	MG-3730
90x90 . 36"x36"	9mm	<b>ASR</b>	R11	MG-3560
	9,5mm	<b>NR</b>	R10	MG-3960
90x90 . 36"x36"	9,5mm	<b>A</b>	-	MG-4290
	9,5mm	<b>NR</b>	R10	MG-4695
60x120 . 24"x48"	9,5mm	<b>A</b>	-	MG-4970

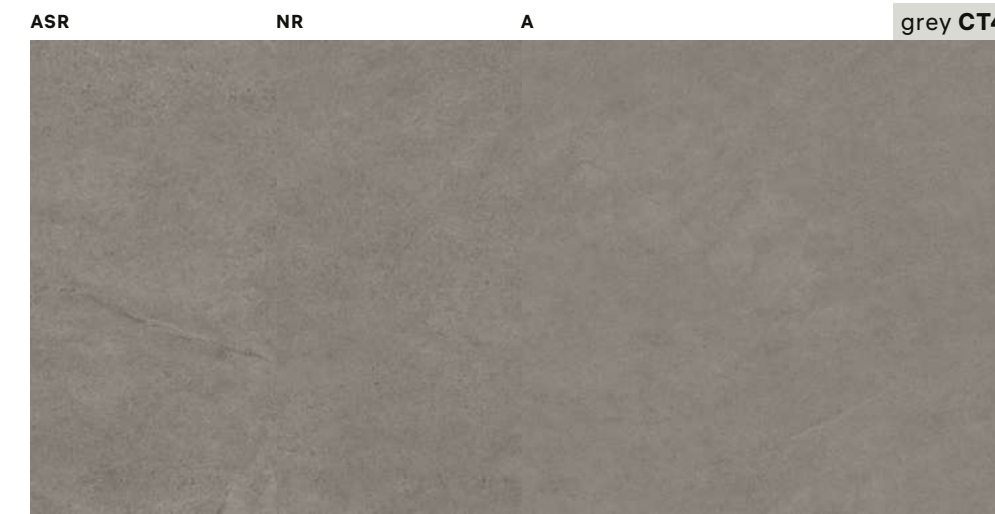

30x60 . 12"x24"	8,5mm	<b>NR</b>	R10	MG-2095
	8,5mm	<b>A</b>	-	MG-2370
60x60 . 24"x24"	8,5mm	<b>NR</b>	R10	MG-2765
	8,5mm	<b>A</b>	-	MG-3080
	8,5mm	<b>ASR</b>	R11	MG-2765
45x90 . 18"x36"	9mm	<b>NR</b>	R10	MG-3560
	9mm	<b>A</b>	-	MG-3730
90x90 . 36"x36"	9mm	<b>ASR</b>	R11	MG-3560
	9,5mm	<b>NR</b>	R10	MG-3960
90x90 . 36"x36"	9,5mm	<b>A</b>	-	MG-4290
	9,5mm	<b>NR</b>	R10	MG-4695
60x120 . 24"x48"	9,5mm	<b>A</b>	-	MG-4970



# concept

collection

## decors

décorations . dekorationen . decorações

8,5MM



mosaic concept 5x5 white  
30x30 . 12"x12"  
NR MG-9570  
A MG-9745



mosaic concept 5x5 beige  
30x30 . 12"x12"  
NR MG-9570  
A MG-9745



mosaic concept 5x5 light grey  
30x30 . 12"x12"  
NR MG-9570  
A MG-9745

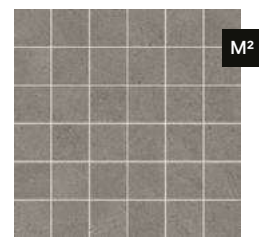

mosaic concept 5x5 grey  
30x30 . 12"x12"  
NR MG-9570  
A MG-9745

8,5MM

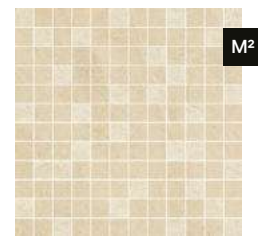

mosaic concept 2,3x2,3 white mix  
30x30 . 12"x12"  
A MG-9790

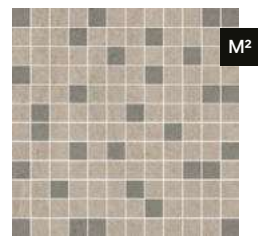

mosaic concept 2,3x2,3 grey mix  
30x30 . 12"x12"  
A MG-9790

8,5MM



bricks concept white  
15x60 . 6"x24"  
NR MP-6320  
A MP-6330



bricks concept beige  
15x60 . 6"x24"  
NR MP-6320  
A MP-6330



bricks concept light grey  
15x60 . 6"x24"  
NR MP-6320  
A MP-6330



bricks concept grey  
15x60 . 6"x24"  
NR MP-6320  
A MP-6330

Mosaic and Brick decors are net mounted. All decors may feature shade variations regarding the corresponding floor/wall tile standard tile.  
Les décorations Mosaic et Brick sont sur trame. Toutes les décorations peuvent souffrir variations de tonalité par rapport aux carreaux base.  
Die Mosaic und Brick Dekoration liegen auf einem Netz. Alle Dekorationen können im Vergleich zu den jeweiligen Grundiesen Farbunterschiede aufweisen.  
As decorações Mosaic and Brick são sobre rede. Todas as decorações podem sofrer variações de tonalidade em relação aos respectivos mosaicos base.

**MARGRES**  
CERAMIC TILES

# concept

collection

## special pieces

pièces spéciales . spezialteile . peças especiais

9,5 . 8,5MM

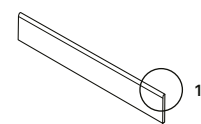

skirting  
plinthe  
sockel  
rodapé boleado

8x60 . 3,2"x24"  
NR MP-6170  
A MP-6180  
8x90 . 3,2"x36"  
NR MP-6260  
A MP-6270  
8x120 . 3,2"x48"  
NR MP-6260  
A MP-6270

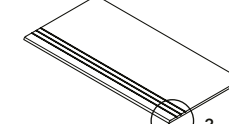
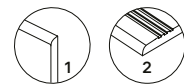

step tread grooved  
nez de marche creusé  
stufenplatte mit rillen  
degrau sulcado

30x60 . 12"x24"  
NR . ASR MP-6240  
A MP-6270  
30x90 . 12"x36"  
NR . ASR MP-6430  
A MP-6445  
30x120 . 12"x48"  
NR MP-6445  
A MP-6470

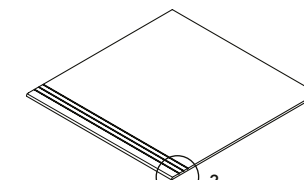

step tread grooved  
nez de marche creusé  
stufenplatte mit rillen  
degrau sulcado

60x60 . 24"x24"  
NR . ASR MP-6400  
A MP-6430



9,5 . 8,5MM

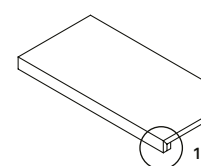

step extra thick  
nez de marche forte épaisseur  
massive stufenplatte  
degrau espessurado

30x60 . 12"x24"  
NR . A MP-6560  
30x120 . 12"x48"  
NR . A MP-6650

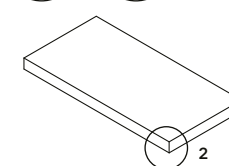
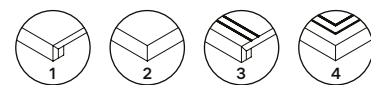

step extra thick corner\*  
nez de marche forte épaisseur angle\*  
ecke massive stufenplatte\*  
degrau espessurado canto\*

30x60 . 12"x24"  
NR . A MP-6630  
30x120 . 12"x48"  
NR . A MP-6690

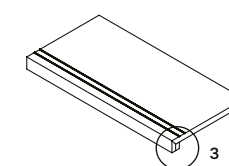

step extra thick inox  
nez de marche forte épaisseur inox  
massive stufenplatte inox  
degrau espessurado inox

30x60 . 12"x24"  
NR . A MP-6580  
30x120 . 12"x48"  
NR . A MP-6670

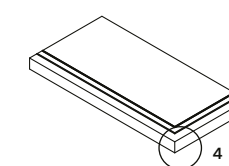

step extra thick corner inox\*  
nez de marche forte épaisseur angle inox\*  
ecke massive stufenplatte inox\*  
degrau espessurado canto inox\*

30x60 . 12"x24"  
NR . A MP-6650  
30x120 . 12"x48"  
NR . A MP-6710



step extra thick corner . nez de marche forte épaisseur angle  
ecke massive stufenplatte . degrau espessurado canto

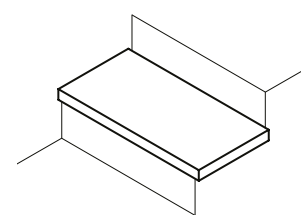

right corner . angle droit  
rechten ecke . canto direito

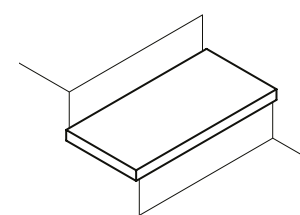

left corner . angle gauche  
links ecke . canto esquerdo



step extra thick corner inox . nez de marche forte épaisseur angle inox  
ecke massive stufenplatte inox . degrau espessurado canto inox

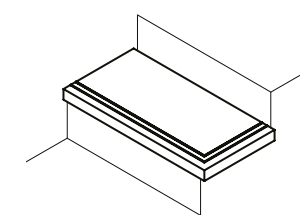

right corner . angle droit  
rechten ecke . canto direito

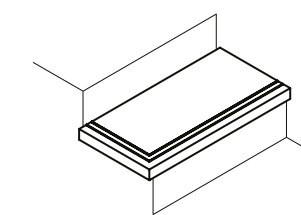

left corner . angle gauche  
links ecke . canto esquerdo

Available in all colours  
Disponible dans toutes les couleurs  
Erhältlich in allen Farben  
Disponível em todas as cores

\*Available in right and left corner  
\*Disponible dans les coin droit et gauche  
\*Erhältlich in der rechten Ecke und links  
\*Disponível no canto direito e esquerdo

\*\* Dimension will vary depending on the base tile thickness.  
\*\* La dimension varie selon l'épaisseur du carreau.  
\*\* das Maß variiert je nach Dicke der Fliese.  
\*\* A dimensão varia consoante a espessura do material cerâmico.

index

colour map

collections

concept

edge

endless

evoke

extreme

grove

hybrid

jungle

natural

prestige

pure stone

slabstone

subway

tecnica

time 2.0

tool

underground

linea collections

useful information





116

general catalogue . 2023

snow E01 60x60 NR

**TECHNICAL**  
FULL BODY  
PORCELAIN

**edge**  
collection

↓  
DOWNLOAD  
CATALOGUE

↓  
DOWNLOAD  
TECHNICAL  
FEATURES

🌐  
VIEW  
ONLINE

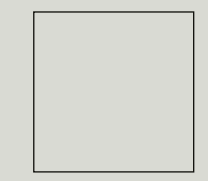

**90x90**  
NR 11mm  
TC 11mm  
P 10,5mm

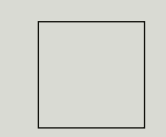

**60x60**  
NR 10mm  
TC 10mm  
P 9,5mm  
ASR 10mm

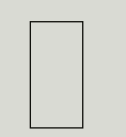

**30x60**  
NR 10mm  
TC 10mm  
P 9,5mm

rectified products . produits rectifiés . rektifizierete produkte . produtos retificados



snow  
E01

cream  
E02

silver  
E03

taupe  
E04

carbon  
E05

**UGL** **V2** **R11** **R10** 🧑🧑🧑🧑



pour plus d'informations, consultez  
<https://evaluation.cstb.fr>

**MARGRES**  
CERAMIC TILES

117

general catalogue . 2023

index

colour map

**collections**

concept

**edge**

endless

evoke

extreme

grove

hybrid

jungle

natural

prestige

pure stone

slabstone

subway

tecnica

time 2.0

tool

underground

linea collections

useful information



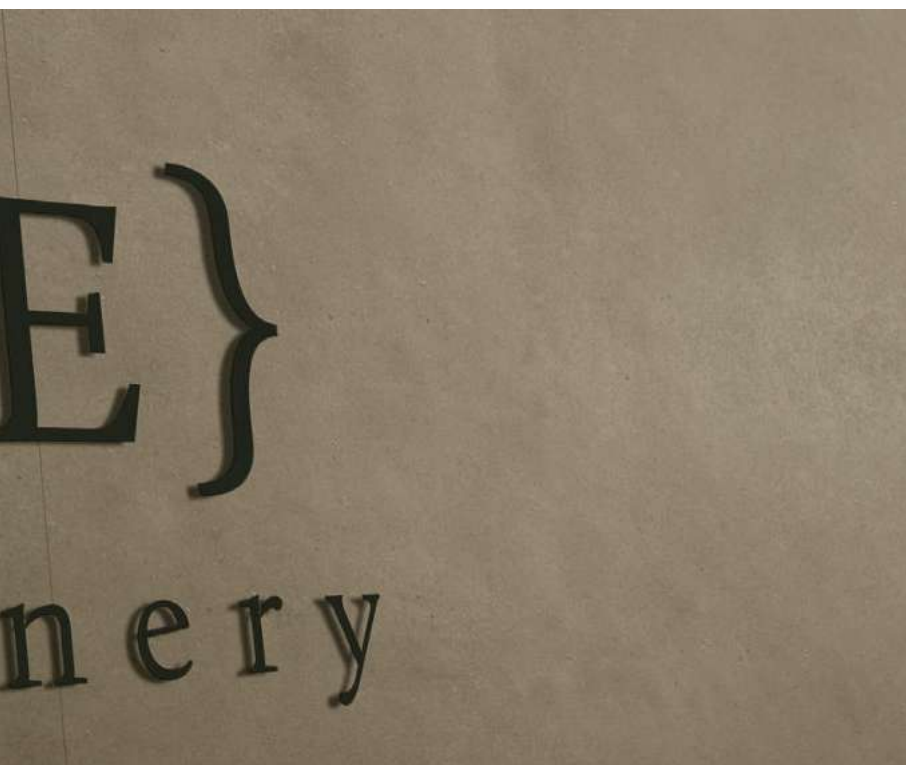

taupe E04 90x90 NR . 90x90 P





120

general catalogue . 2023



121

general catalogue . 2023

cream E02 60x60 NR . 60x60 P









index

colour map

collections

concept

edge

endless

evoke

extreme

grove

hybrid

jungle

natural

prestige

pure stone

slabstone

subway

tecnica

time 2.0

tool

underground

linea collections

useful information



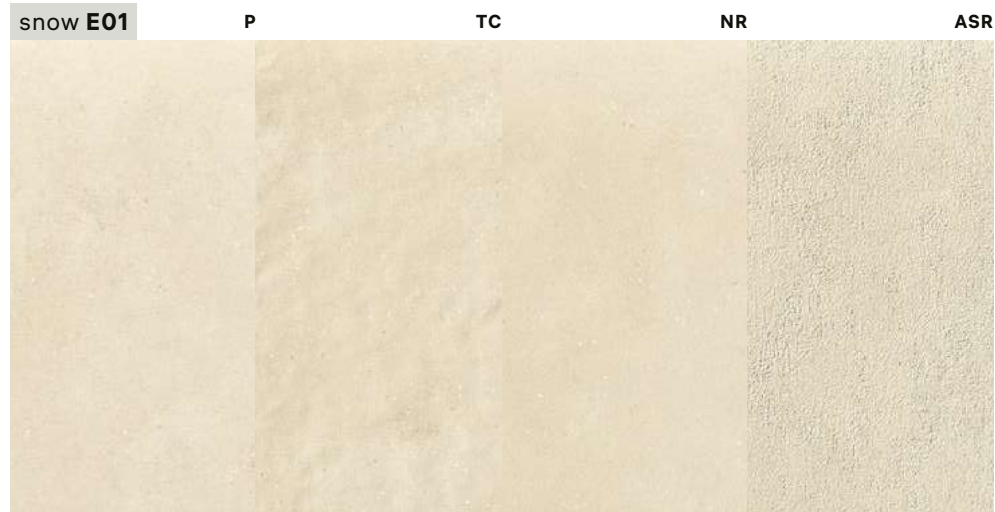

30x60 . 12"x24"	10mm	NR	R10	MG-2160
	10mm	TC	-	MG-2160
	9,5mm	P	-	MG-2625
60x60 . 24"x24"	10mm	NR	R10	MG-2840
	10mm	TC	-	MG-2840
	9,5mm	P	-	MG-3305
90x90 . 36"x36"	10mm	ASR	R11	MG-2840
	11mm	NR	R10	MG-4035
	11mm	TC	-	MG-4035
	10,5mm	P	-	MG-4535

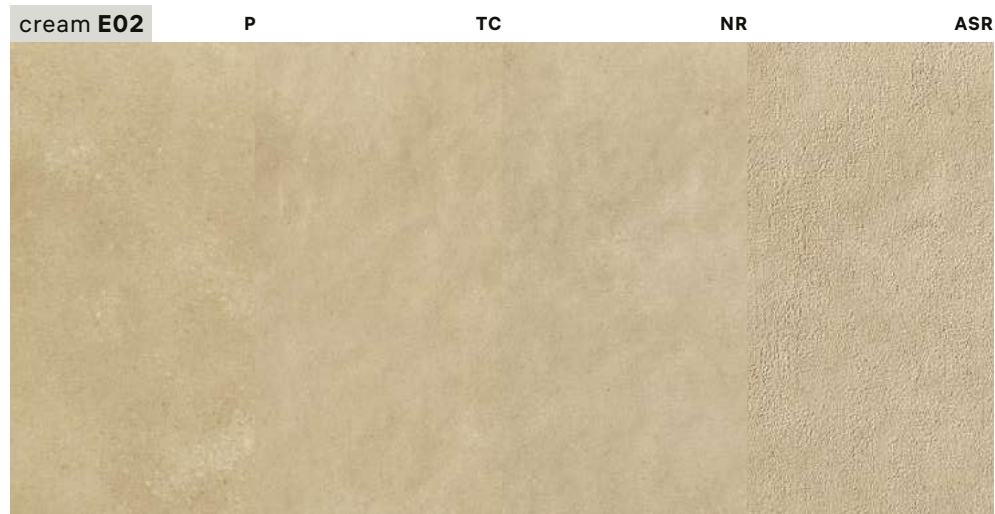

30x60 . 12"x24"	10mm	NR	R10	MG-2115
	10mm	TC	-	MG-2115
	9,5mm	P	-	MG-2585
60x60 . 24"x24"	10mm	NR	R10	MG-2800
	10mm	TC	-	MG-2800
	9,5mm	P	-	MG-3265
90x90 . 36"x36"	10mm	ASR	R11	MG-2800
	11mm	NR	R10	MG-4005
	11mm	TC	-	MG-4005
	10,5mm	P	-	MG-4505

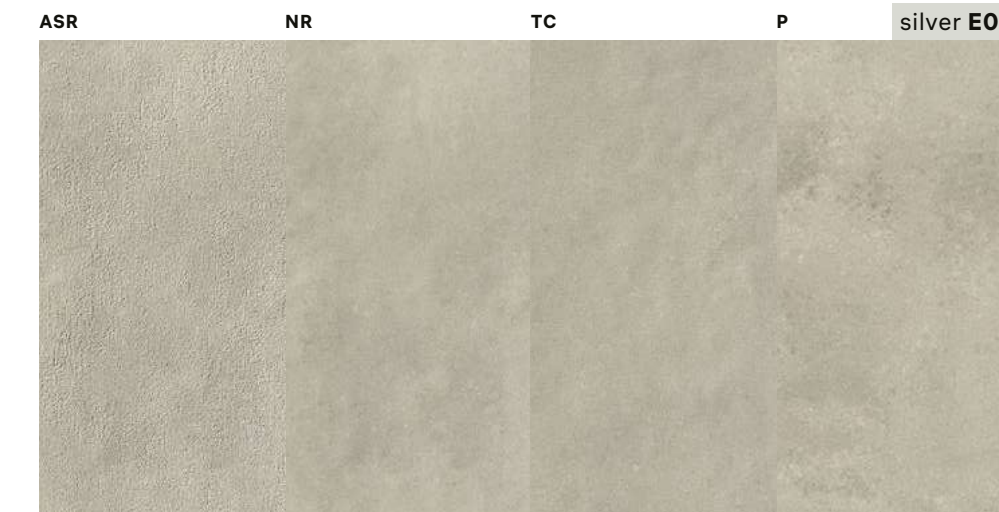

30x60 . 12"x24"	10mm	NR	R10	MG-2115
	10mm	TC	-	MG-2115
	9,5mm	P	-	MG-2585
60x60 . 24"x24"	10mm	NR	R10	MG-2800
	10mm	TC	-	MG-2800
	9,5mm	P	-	MG-3265
90x90 . 36"x36"	10mm	ASR	R11	MG-2800
	11mm	NR	R10	MG-4005
	11mm	TC	-	MG-4005
	10,5mm	P	-	MG-4505

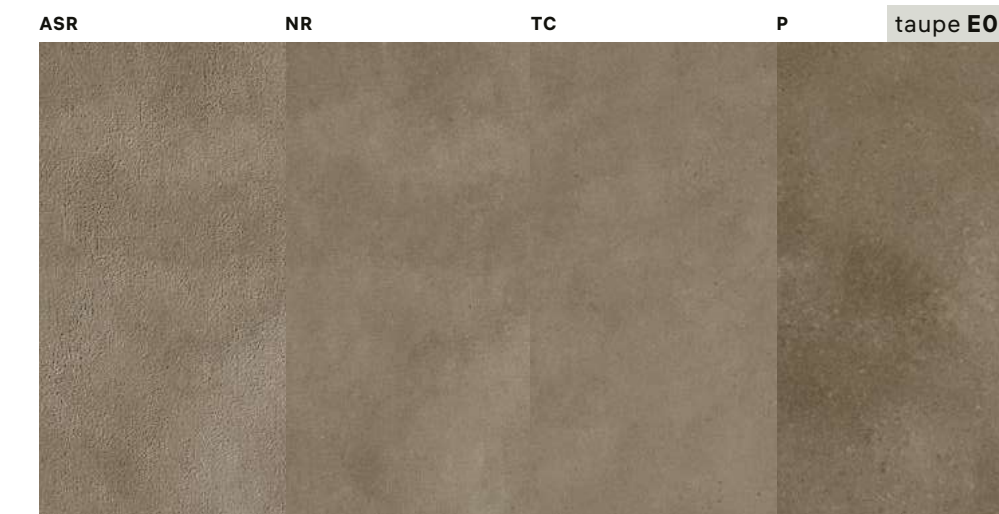

30x60 . 12"x24"	10mm	NR	R10	MG-2115
	10mm	TC	-	MG-2115
	9,5mm	P	-	MG-2585
60x60 . 24"x24"	10mm	NR	R10	MG-2800
	10mm	TC	-	MG-2800
	9,5mm	P	-	MG-3265
90x90 . 36"x36"	10mm	ASR	R11	MG-2800
	11mm	NR	R10	MG-4005
	11mm	TC	-	MG-4005
	10,5mm	P	-	MG-4505

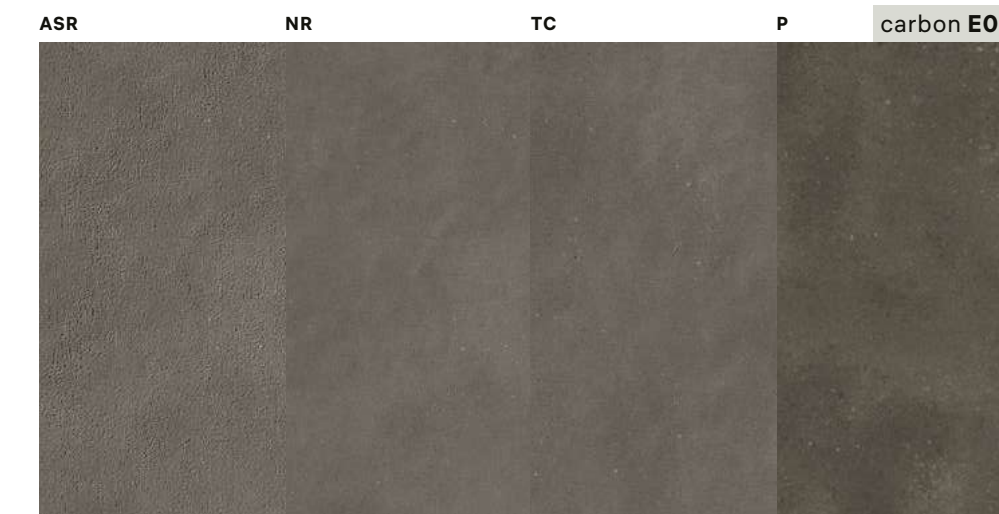

30x60 . 12"x24"	10mm	NR	R10	MG-2115
	10mm	TC	-	MG-2115
	9,5mm	P	-	MG-2585
60x60 . 24"x24"	10mm	NR	R10	MG-2800
	10mm	TC	-	MG-2800
	9,5mm	P	-	MG-3265
90x90 . 36"x36"	10mm	ASR	R11	MG-2800
	11mm	NR	R10	MG-4005
	11mm	TC	-	MG-4005
	10,5mm	P	-	MG-4505



## edge

collection

## decors

décorations . dekorationen . decorações

TC 10MM . P 9,5MM



mosaic edge 5x5 snow  
30x30 . 12"x12"

TC MG-9580  
P MG-9830



mosaic edge 5x5 cream  
30x30 . 12"x12"

TC MG-9580  
P MG-9830



mosaic edge 5x5 silver  
30x30 . 12"x12"

TC MG-9580  
P MG-9830



mosaic edge 5x5 taupe  
30x30 . 12"x12"

TC MG-9580  
P MG-9830



mosaic edge 5x5 carbon  
30x30 . 12"x12"

TC MG-9580  
P MG-9830

TC 10MM . P 9,5MM



bricks edge snow

26x60 . 10"x24"  
TC . P MP-6330



bricks edge cream

26x60 . 10"x24"  
TC . P MP-6330



bricks edge silver

26x60 . 10"x24"  
TC . P MP-6330



bricks edge taupe

26x60 . 10"x24"  
TC . P MP-6330



bricks edge carbon

26x60 . 10"x24"  
TC . P MP-6330

Mosaic and Brick decors are net mounted. All decors may feature shade variations regarding the corresponding floor/wall tile standard tile.

Les décorations Mosaic et Brick sont sur trame. Toutes les décorations peuvent souffrir variations de tonalité par rapport aux carreaux base.

Die Mosaic und Brick Dekoration liegen auf einem Netz. Alle Dekorationen können im Vergleich zu den jeweiligen Grundiesen Farbunterschiede aufweisen.

As decorações Mosaic and Brick são sobre rede. Todas as decorações podem sofrer variações de tonalidade em relação aos respectivos mosaicos base.

**MARGRES**  
CERAMIC TILES

## special pieces

pièces spéciales . spezialteile . peças especiais

NR.TC.ASR 11 . 10MM . P 10,5 . 9,5MM

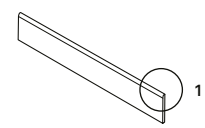

skirting  
plinthe  
sockel  
rodapé boleado

8x60 . 3,2"x24"

NR . TC MP-6170  
P MP-6180

8x90 . 3,2"x36"

NR . TC MP-6260  
P MP-6270

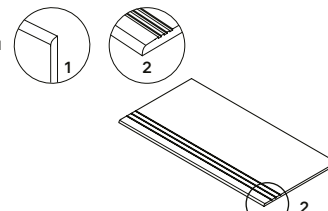

step tread grooved  
nez de marche creusé  
stufenplatte mit rillen  
degrau sulcado

30x60 . 12"x24"

NR . TC . ASR MP-6240  
P MP-6270

30x90 . 12"x36"

NR . TC MP-6430  
P MP-6445

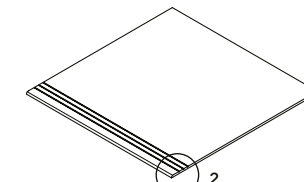

step tread grooved  
nez de marche creusé  
stufenplatte mit rillen  
degrau sulcado

60x60 . 24"x24"

NR . TC . ASR MP-6400  
P MP-6430

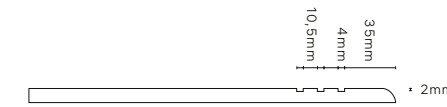

NR.TC 10MM . P 9,5MM

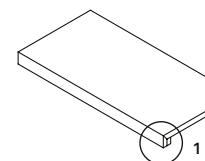

step extra thick  
nez de marche forte épaisseur  
massive stufenplatte  
degrau espessurado

30x60 . 12"x24"

NR . TC . P MP-6560

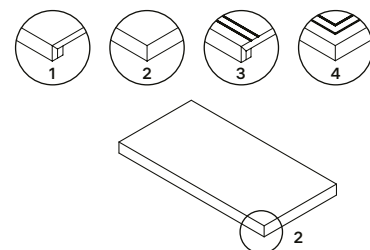

step extra thick corner\*  
nez de marche forte épaisseur angle\*  
ecke massive stufenplatte\*  
degrau espessurado canto\*

30x60 . 12"x24"

NR . TC . P MP-6630

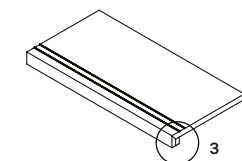

step extra thick inox  
nez de marche forte épaisseur inox  
massive stufenplatte inox  
degrau espessurado inox

30x60 . 12"x24"

NR . TC . P MP-6580

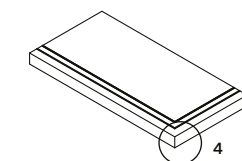

step extra thick corner inox\*  
nez de marche forte épaisseur angle inox\*  
ecke massive stufenplatte inox\*  
degrau espessurado canto inox\*

30x60 . 12"x24"

NR . TC . P MP-6650

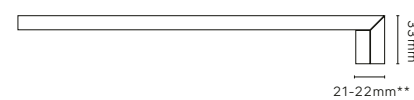

step extra thick corner . nez de marche forte épaisseur angle  
ecke massive stufenplatte . degrau espessurado canto

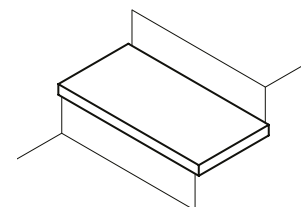

right corner . angle droit  
rechten ecke . canto direito

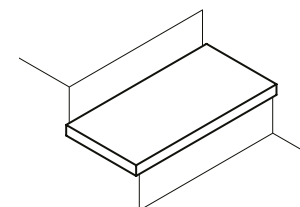

left corner . angle gauche  
links ecke . canto esquerdo



step extra thick corner inox . nez de marche forte épaisseur angle inox  
ecke massive stufenplatte inox . degrau espessurado canto inox

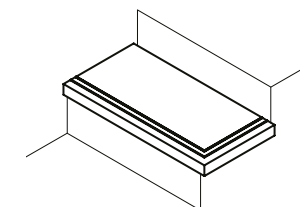

right corner . angle droit  
rechten ecke . canto direito

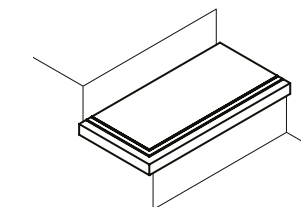

left corner . angle gauche  
links ecke . canto esquerdo

Available in all colours

Disponible dans toutes les couleurs

Erhältlich in allen Farben

Disponível em todas as cores

\*Available in right and left corner

\*Disponible dans les coin droit et gauche

\*Erhältlich in der rechten Ecke und links

\*Disponível no canto direito e esquerdo

\*\* Dimension will vary depending on the base tile thickness.

\*\* La dimension varie selon l'épaisseur du carreau.

\*\* das Maß variiert je nach Dicke der Fliese.

\*\* A dimensão varia consoante a espessura do material cerâmico.

index

colour map

collections

concept

edge

endless

evoke

extreme

grove

hybrid

jungle

natural

prestige

pure stone

slabstone

subway

tecnica

time 2.0

tool

underground

linea collections

useful information









tortora GR4 20x120 N

DIGITEK  
PORCELAIN  
STONEWARE

grove  
collection

-   
 DOWNLOAD  
CATALOGUE
-   
 DOWNLOAD  
TECHNICAL  
FEATURES
-   
 VIEW  
ONLINE
-   
 DOWNLOAD  
CATALOGUE  
OUTDOOR  
EXTRA THICK

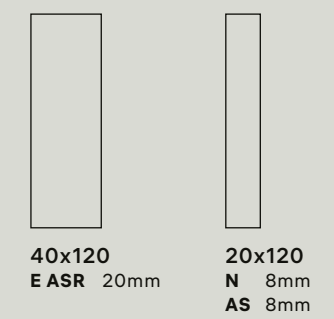

N . AS non-rectified products . produits non rectifiés . nicht rektifizierte produkte . produtos não retificados  
E ASR rectified products . produits rectifiés . rektifizierte produkte . produtos retificados



white GR1    beige GR2    grey GR3    tortora GR4    light brown GR5    brown GR6

UGL V2 R11 R10 

**QB** UPEC·F+

pour plus d'informations, consultez  
<https://evaluation.cstb.fr>

**MARGRES**  
CERAMIC TILES

- index
- colour map
- collections**
- concept
- edge
- endless
- evoke
- extreme
- grove
- hybrid
- jungle
- natural
- prestige
- pure stone
- slabstone
- subway
- tecnica
- time 2.0
- tool
- underground
- linea collections
- useful information







concept

edge

endless

evoke

extreme

grove

hybrid

jungle

natural

prestige

pure stone

slabstone

subway

tecnica

time 2.0

tool

underground

linea collections

useful information



134

general catalogue . 2023

135

general catalogue . 2023



grove

collection

grove

collection

index

colour map

collections

concept

edge

endless

evoke

extreme

grove

hybrid

jungle

natural

prestige

pure stone

slabstone

subway

tecnica

time 2.0

tool

underground

linea collections

useful information

136

general catalogue . 2023

137

general catalogue . 2023

brown GR6 20x120 N . light brown GR5 20x120 AS





138

general catalogue . 2023



139

general catalogue . 2023





140

141

general catalogue, 2023

general catalogue, 2023

light brown GR5 40x120 E ASR

index

colour map

collections

concept

edge

endless

evoke

extreme

grove

hybrid

jungle

natural

prestige

pure stone

slabstone

subway

tecnica

time 2.0

tool

underground

linea collections

useful information



**grove**  
collection

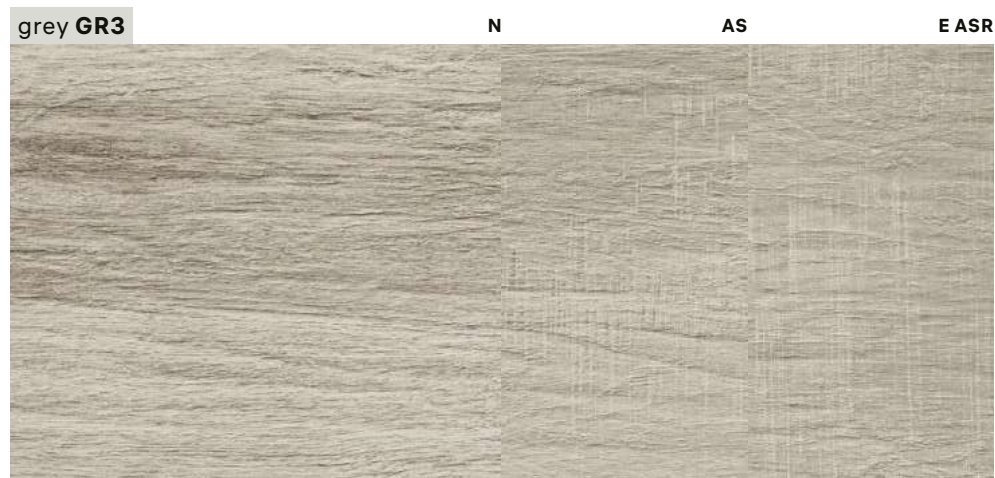
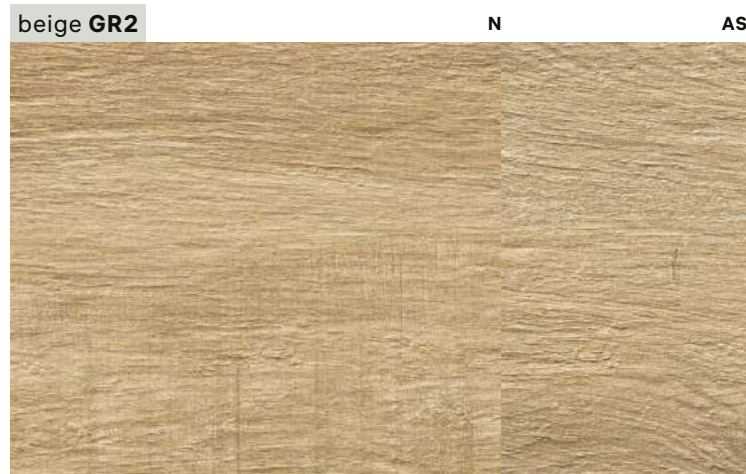

20x120 . 8"x48"	8mm	N	R10	MG-1220
-----------------	-----	---	-----	---------

20x120 . 8"x48"	8mm	N	R10	MG-1220
	8mm	AS	R11	MG-1245

20x120 . 8"x48"	8mm	N	R10	MG-1220
	8mm	AS	R11	MG-1245
40x120 . 16"x48"	20mm	E ASR	R11	MG-7290

**grove**  
collection

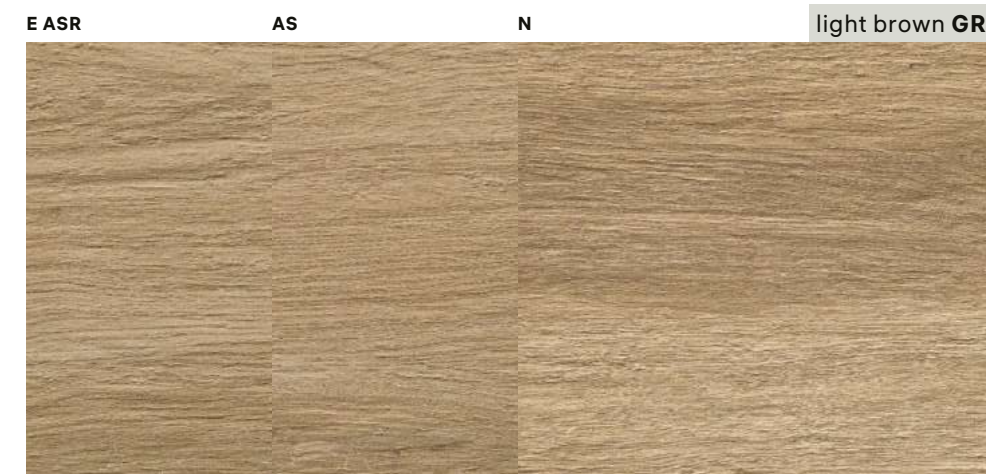

20x120 . 8"x48"	8mm	N	R10	MG-1220
	8mm	AS	R11	MG-1245

20x120 . 8"x48"	8mm	N	R10	MG-1220
	8mm	AS	R11	MG-1245
40x120 . 16"x48"	20mm	E ASR	R11	MG-7290

20x120 . 8"x48"	8mm	N	R10	MG-1220
-----------------	-----	---	-----	---------

142

143

general catalogue . 2023

general catalogue . 2023

**laying suggestions**

suggestions de pose . anwendungsvorschläge . sugestões de aplicação

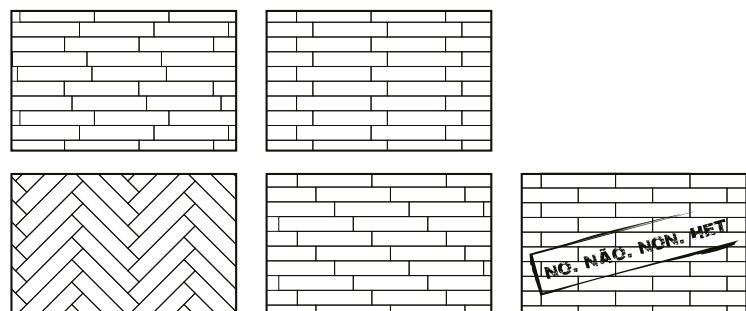

**special pieces**

pièces spéciales . spezialteile . peças especiais

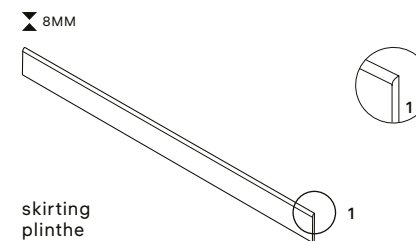

skirting  
plinthe  
sockel  
rodapé boleado  
8x120 . 3,2" x 48"  
N MP-6200

Available in all colours  
Disponible dans toutes les couleurs  
Erhältlich in allen Farben  
Disponível em todas as cores

**MARGRES**  
CERAMIC TILES

index

colour map

collections

concept

edge

endless

evoke

extreme

grove

hybrid

jungle

natural

prestige

pure stone

slabstone

subway

tecnica

time 2.0

tool

underground

linea collections

useful information





144

general catalogue . 2023

light grey TL2 45x90 A

LAMINATED  
PORCELAIN  
STONEWARE

FULL BODY  
PORCELAIN

↓  
DOWNLOAD  
CATALOGUE  
OUTDOOR  
EXTRA THICK

**tool**

collection

↓  
DOWNLOAD  
CATALOGUE

↓  
DOWNLOAD  
TECHNICAL  
FEATURES

🌐  
VIEW  
ONLINE

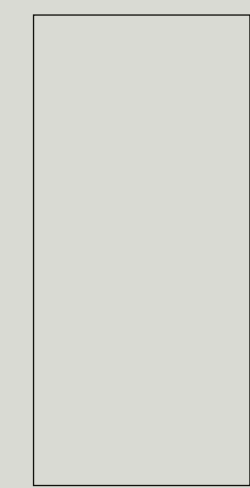

120x260  
NR 6mm

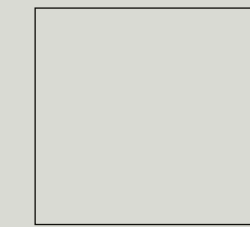

120x120  
NR 6mm

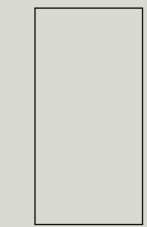

60x120  
NR 6mm

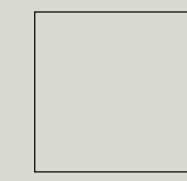

90x90  
NR 9,5mm  
A 9,5mm  
ASR 9,5mm



45x90  
NR 9mm  
A 9mm

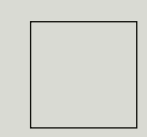

60x60  
NR 8,5mm  
TC 8,5mm  
A 8,5mm  
E ASR 20mm

rectified products . produits rectifiés . rektifizierte produkte . produtos retificados



white  
TL1 . LTL1

light grey  
TL2 . LTL2

tortora  
TL3 . LTL3

grey  
TL4 . LTL4

UGL V3 R11 R10 R9



**PROTECT**  
Antibacterial for Life.

pour plus d'informations, consultez  
<https://evaluation.cstb.fr>

**MARGRES**  
CERAMIC TILES

145

general catalogue . 2023

index

colour map

collections

concept

edge

endless

evoke

extreme

grove

hybrid

jungle

natural

prestige

pure stone

slabstone

subway

tecnica

time 2.0

**tool**

underground

linea collections

useful information





146

general catalogue . 2023

mosaic hexagon tool white 24x26,6 NR



147

general catalogue . 2023

white TL1 45x90 NR









150

general catalogue . 2023

tortora TL3 90x90 NR

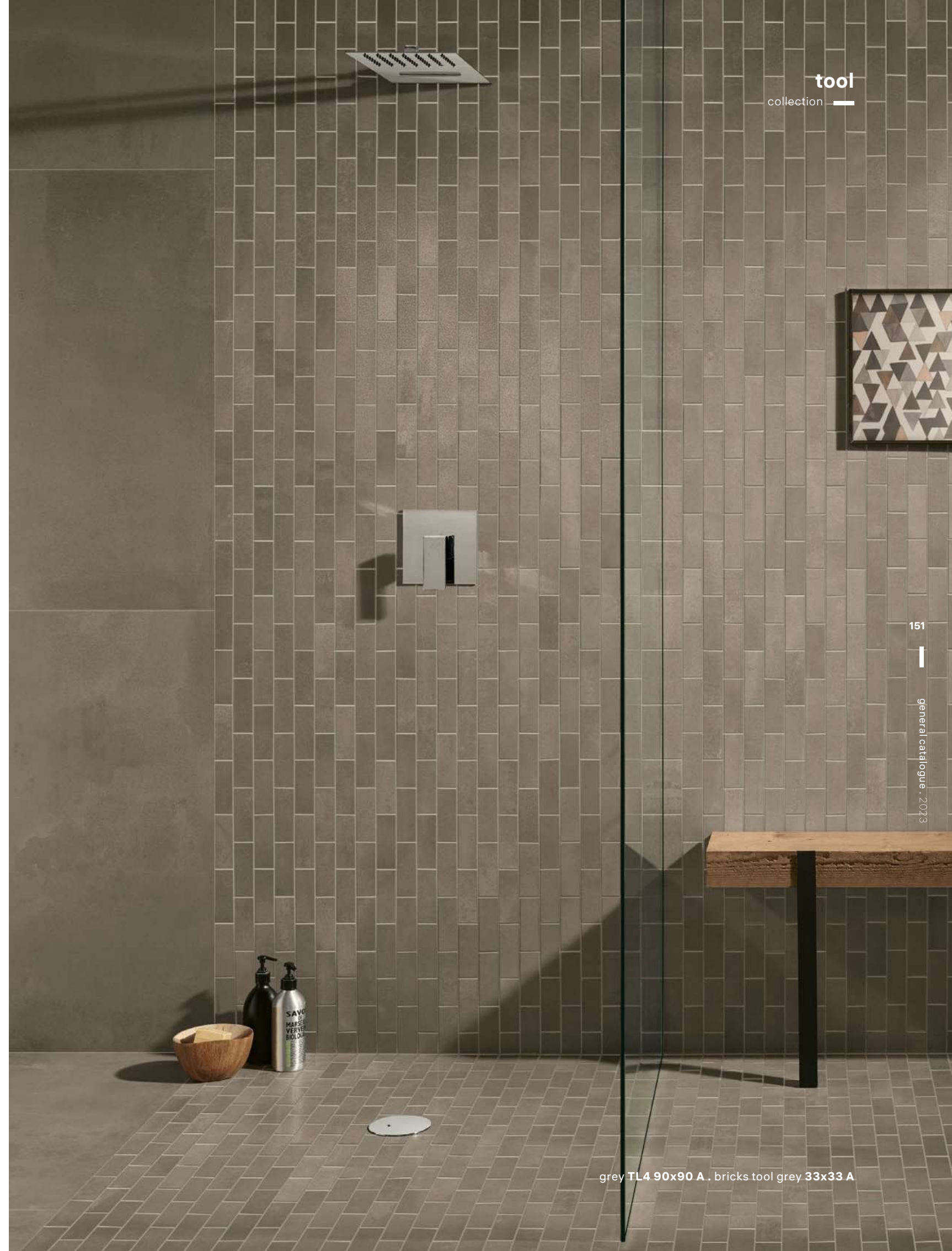

151

general catalogue . 2023

grey TL4 90x90 A . bricks tool grey 33x33 A

index

colour map

**collections**

concept

edge

endless

evoke

extreme

grove

hybrid

jungle

natural

prestige

pure stone

slabstone

subway

tecnica

time 2.0

**tool**

underground

linea collections

useful information



**tool**  
collection

152

general catalogue . 2023

light grey TL2 90x90 ASR



**tool**  
collection

153

general catalogue . 2023

grey TL4 60x60 E ASR

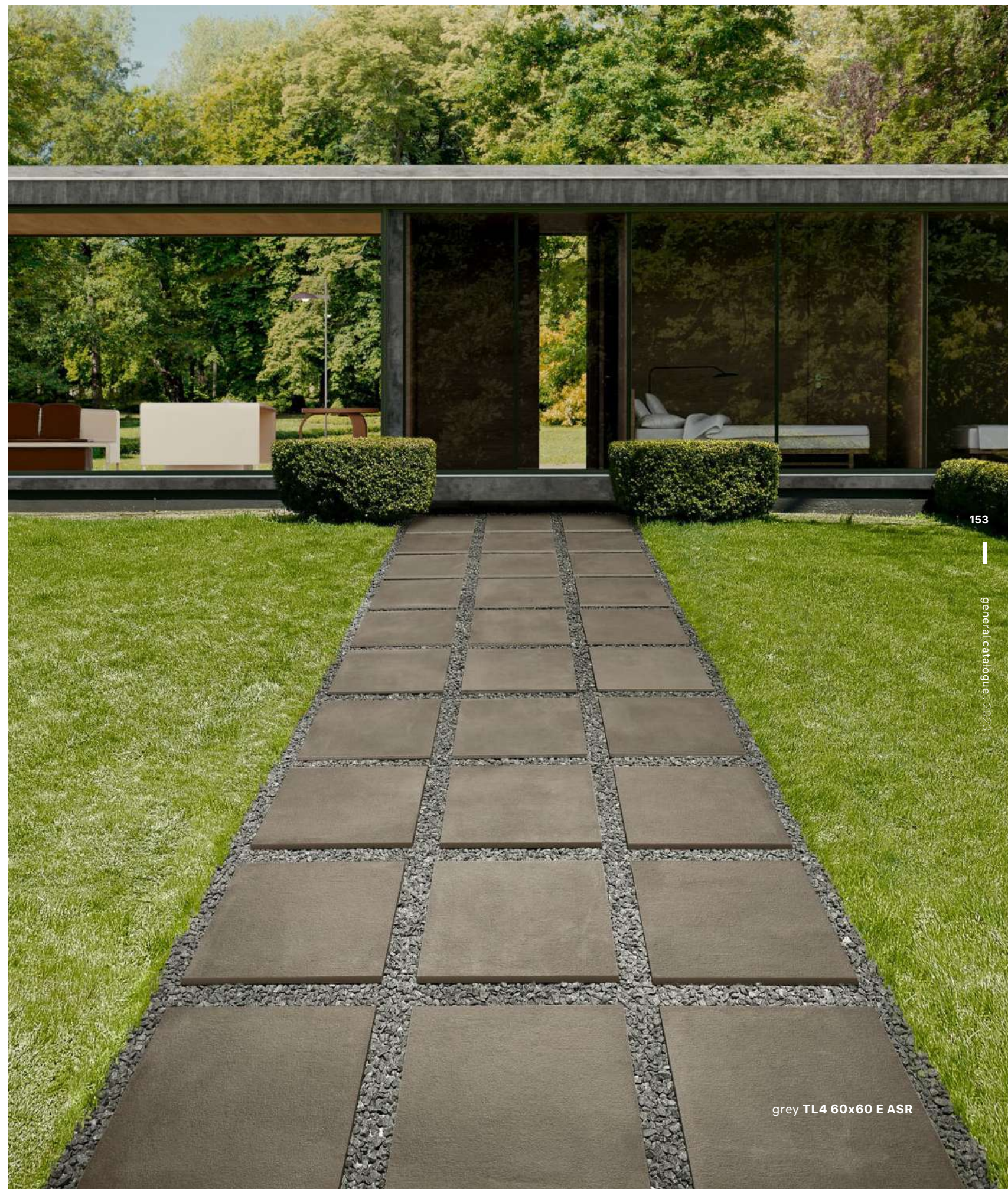

index

colour map

**collections**

concept

edge

endless

evoke

extreme

grove

hybrid

jungle

natural

prestige

pure stone

slabstone

subway

tecnica

time 2.0

**tool**

underground

linea collections

useful information



**tool**

collection

white TL1 . LTL1 A TC NR E ASR

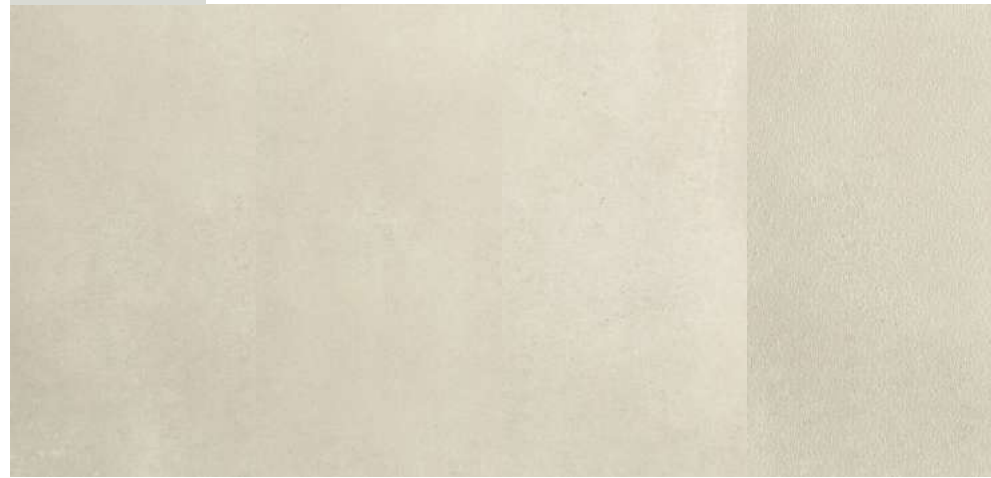

60x60 . 24"x24"	8,5mm	NR	R10	MG-2765
	8,5mm	TC	-	MG-2765
	8,5mm	A	-	MG-3080
	20mm	E ASR	R11	MG-7090
45x90 . 18"x36"	9mm	NR	R10	MG-3560
	9mm	A	-	MG-3730
90x90 . 36"x36"	9,5mm	NR	R10	MG-3960
	9,5mm	A	-	MG-4290

**LINEA**

60x120 . 24"x48"	6mm	NR	R9	M3-5730
120x120 . 48"x48"	6mm	NR	R9	M3-6730
120x260 . 48"x102"	6mm	NR	R9	M3-8230

tortora TL3 . LTL3 A TC NR E ASR



60x60 . 24"x24"	8,5mm	NR	R10	MG-2765
	8,5mm	TC	-	MG-2765
	8,5mm	A	-	MG-3080
	20mm	E ASR	R11	MG-7090
45x90 . 18"x36"	9mm	NR	R10	MG-3560
	9mm	A	-	MG-3730
90x90 . 36"x36"	9,5mm	NR	R10	MG-3960
	9,5mm	A	-	MG-4290

**LINEA**

60x120 . 24"x48"	6mm	NR	R9	M3-5730
120x120 . 48"x48"	6mm	NR	R9	M3-6730
120x260 . 48"x102"	6mm	NR	R9	M3-8230

**tool**

collection

ASR . E ASR NR TC A light grey TL2 . LTL2



60x60 . 24"x24"	8,5mm	NR	R10	MG-2765
	8,5mm	TC	-	MG-2765
	8,5mm	A	-	MG-3080
	20mm	E ASR	R11	MG-7090
45x90 . 18"x36"	9mm	NR	R10	MG-3560
	9mm	A	-	MG-3730
90x90 . 36"x36"	9,5mm	NR	R10	MG-3960
	9,5mm	A	-	MG-4290
	9,5mm	ASR	R11	MG-3960

**LINEA**

60x120 . 24"x48"	6mm	NR	R9	M3-5730
120x120 . 48"x48"	6mm	NR	R9	M3-6730
120x260 . 48"x102"	6mm	NR	R9	M3-8230

ASR . E ASR NR TC A grey TL4 . LTL4

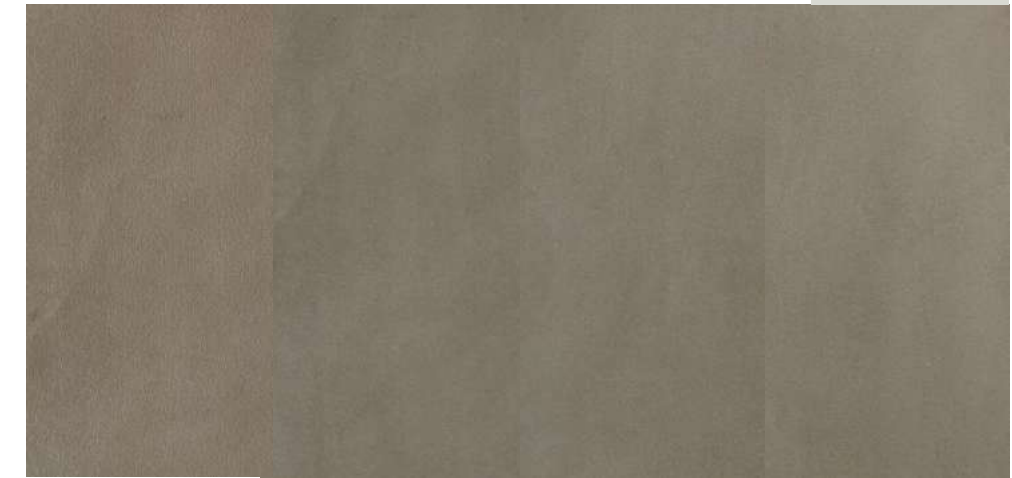

60x60 . 24"x24"	8,5mm	NR	R10	MG-2765
	8,5mm	TC	-	MG-2765
	8,5mm	A	-	MG-3080
	20mm	E ASR	R11	MG-7090
45x90 . 18"x36"	9mm	NR	R10	MG-3560
	9mm	A	-	MG-3730
90x90 . 36"x36"	9,5mm	NR	R10	MG-3960
	9,5mm	A	-	MG-4290
	9,5mm	ASR	R11	MG-3960

**LINEA**

60x120 . 24"x48"	6mm	NR	R9	M3-5730
120x120 . 48"x48"	6mm	NR	R9	M3-6730
120x260 . 48"x102"	6mm	NR	R9	M3-8230



## tool

collection

### decors

décorations . dekorationen . decorações

8,5MM

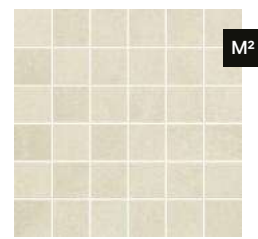

mosaic tool 5x5 white  
**30x30** . 12"x12"  
NR MG-9570



mosaic tool 5x5 light grey  
**30x30** . 12"x12"  
NR MG-9570



mosaic tool 5x5 tortora  
**30x30** . 12"x12"  
NR MG-9570

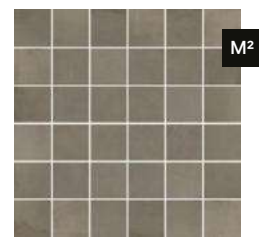

mosaic tool 5x5 grey  
**30x30** . 12"x12"  
NR MG-9570

8,5MM



bricks tool white  
**33x33** . 13"x13"  
NR MG-9570  
A MG-9745



bricks tool light grey  
**33x33** . 13"x13"  
NR MG-9570  
A MG-9745



bricks tool tortora  
**33x33** . 13"x13"  
NR MG-9570  
A MG-9745



bricks tool grey  
**33x33** . 13"x13"  
NR MG-9570  
A MG-9745

8,5MM

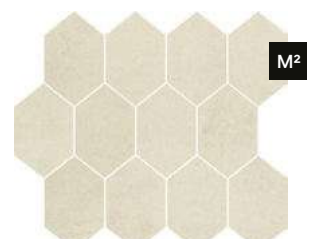

mosaic hexagon tool white  
**24x26,6** . 9"x10"  
NR MG-9660



mosaic hexagon tool light grey  
**24x26,6** . 9"x10"  
NR MG-9660



mosaic hexagon tool tortora  
**24x26,6** . 9"x10"  
NR MG-9660



mosaic hexagon tool grey  
**24x26,6** . 9"x10"  
NR MG-9660

8,5MM



barra tool  
(all colours)  
**10x60** . 4"x24"  
NR . A MP-6080

Mosaic and Brick decors are net mounted. All decors may feature shade variations regarding the corresponding floor/wall tile standard tile.

Les décorations Mosaic et Brick sont sur trame. Toutes les décorations peuvent souffrir variations de tonalité par rapport aux carreaux base.

Die Mosaic und Brick Dekoration liegen auf einem Netz. Alle Dekorationen können im Vergleich zu den jeweiligen Grundiesen Farbunterschiede aufweisen.

As decorações Mosaic and Brick são sobre rede. Todas as decorações podem sofrer variações de tonalidade em relação aos respectivos mosaicos base.

**MARGRES**  
CERAMIC TILES

### special pieces

pièces spéciales . spezialteile . peças especiais

9,5 . 8,5MM

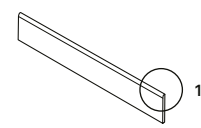

skirting  
plinthe  
sockel  
rodapé boleado

**8x60** . 3,2"x24"

NR . TC MP-6170  
A MP-6180

**8x90** . 3,2"x36"

NR MP-6260  
A MP-6270

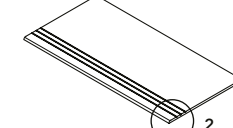
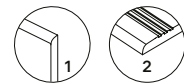

step tread grooved  
nez de marche creusé  
stufenplatte mit rillen  
degrau sulcado

**30x60** . 12"x24"

NR . TC MP-6240  
A MP-6270

**30x90** . 12"x36"

NR\_ASR\* MP-6430  
A MP-6445

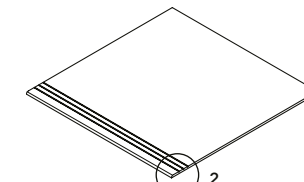

step tread grooved  
nez de marche creusé  
stufenplatte mit rillen  
degrau sulcado

**60x60** . 24"x24"

NR . TC MP-6400  
A MP-6430

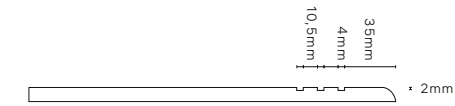

8,5MM

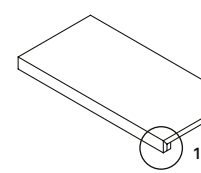

step extra thick  
nez de marche forte épaisseur  
massive stufenplatte  
degrau espessurado

**30x60** . 12"x24"

NR . TC . A MP-6560

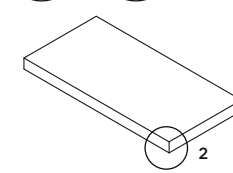
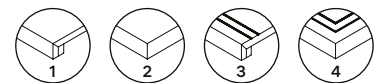

step extra thick corner\*\*  
nez de marche forte épaisseur angle\*\*  
ecke massive stufenplatte\*\*  
degrau espessurado canto\*\*

**30x60** . 12"x24"

NR . TC . A MP-6630

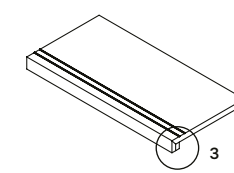

step extra thick inox  
nez de marche forte épaisseur inox  
massive stufenplatte inox  
degrau espessurado inox

**30x60** . 12"x24"

NR . TC . A MP-6580

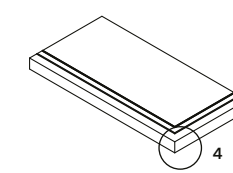

step extra thick corner inox\*\*  
nez de marche forte épaisseur angle inox\*\*  
ecke massive stufenplatte inox\*\*  
degrau espessurado canto inox\*\*

**30x60** . 12"x24"

NR . TC . A MP-6650



step extra thick corner . nez de marche forte épaisseur angle  
ecke massive stufenplatte . degrau espessurado canto

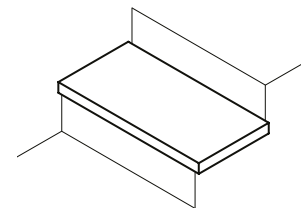

right corner . angle droit  
rechten ecke . canto direito

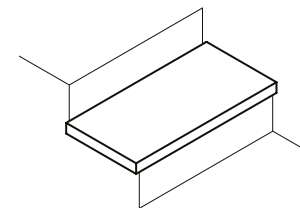

left corner . angle gauche  
links ecke . canto esquerdo



step extra thick corner inox . nez de marche forte épaisseur angle inox  
ecke massive stufenplatte inox . degrau espessurado canto inox

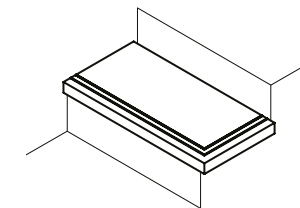

right corner . angle droit  
rechten ecke . canto direito

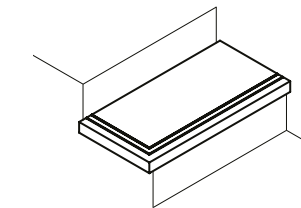

left corner . angle gauche  
links ecke . canto esquerdo

Available in all colours

Disponible dans toutes les couleurs

Erhältlich in allen Farben

Disponível em todas as cores

\*Available only in colours Light Grey and Grey

\*Disponible uniquement dans les couleurs Light Grey et Grey

\*nur in den Farben Light Grey und Grey verfügbar

\*Disponível unicamente nas cores Light Grey e Grey

\*\*Available in right and left corner

\*\*Disponible dans les coin droit et gauche

\*\*Erhältlich in der rechten Ecke und links

\*\*Disponível no canto direito e esquerdo

index

colour map

collections

concept

edge

endless

evoke

extreme

grove

hybrid

jungle

natural

prestige

pure stone

slabstone

subway

tecnica

time 2.0

tool

underground

linea collections

useful information





158

general catalogue . 2023

snow UG1 60x60 NR

TECHNICAL  
FULL BODY  
PORCELAIN

# underground

collection

↓  
DOWNLOAD  
CATALOGUE

↓  
DOWNLOAD  
TECHNICAL  
FEATURES

🌐  
VIEW  
ONLINE

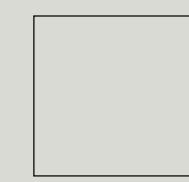

90x90  
NR 9,5mm



45x90  
NR 9mm

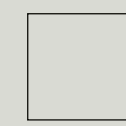

60x60  
NR 8,5mm

rectified products . produits rectifiés . rektifizierte produkte . produtos retificados



snow  
UG1

cream  
UG2

silver  
UG3

carbon  
UG4

UGL V2 R10



pour plus d'informations, consultez  
<https://evaluation.cstb.fr>

**MARGRES**  
CERAMIC TILES

159

general catalogue . 2023

index

colour map

## collections

concept

edge

endless

evoke

extreme

grove

hybrid

jungle

natural

prestige

pure stone

slabstone

subway

tecnica

time 2.0

tool

## underground

linea collections

useful information





160

general catalogue . 2023



161

general catalogue . 2023





index

colour map

**collections**

concept

edge

endless

evoke

extreme

grove

hybrid

jungle

natural

prestige

pure stone

slabstone

subway

tecnica

time 2.0

tool

**underground**

linea collections

useful information







**underground**  
collection

snow **UG1**



NR

60x60 . 24"x24"	8,5mm	NR	R10	MG-2790
45x90 . 18"x36"	9mm	NR	R10	MG-3590
90x90 . 36"x36"	9,5mm	NR	R10	MG-3995

cream **UG2**



NR

60x60 . 24"x24"	8,5mm	NR	R10	MG-2790
45x90 . 18"x36"	9mm	NR	R10	MG-3590
90x90 . 36"x36"	9,5mm	NR	R10	MG-3995

**underground**  
collection

NR



silver **UG3**

60x60 . 24"x24"	8,5mm	NR	R10	MG-2790
45x90 . 18"x36"	9mm	NR	R10	MG-3590
90x90 . 36"x36"	9,5mm	NR	R10	MG-3995

NR



carbon **UG4**

60x60 . 24"x24"	8,5mm	NR	R10	MG-2790
45x90 . 18"x36"	9mm	NR	R10	MG-3590
90x90 . 36"x36"	9,5mm	NR	R10	MG-3995



# underground

collection

## decors

décorations . dekorationen . decorações

8,5MM



mosaic underground 3,5x3,5 snow  
30x30 . 12"x12"  
NR MG-9590



mosaic underground 3,5x3,5 cream  
30x30 . 12"x12"  
NR MG-9590

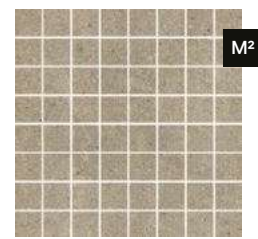

mosaic underground 3,5x3,5 silver  
30x30 . 12"x12"  
NR MG-9590

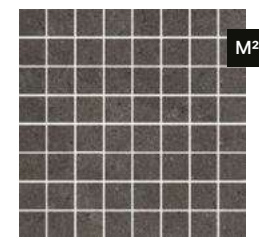

mosaic underground 3,5x3,5 carbon  
30x30 . 12"x12"  
NR MG-9590

# underground

collection

## special pieces

pièces spéciales . spezialteile . peças especiais

9,5 . 8,5MM

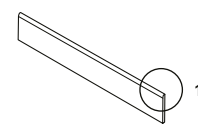

skirting  
plinthe  
sockel  
rodapé boleado  
8x60 . 3,2"x24"  
NR MP-6170  
8x90 . 3,2"x36"  
NR MP-6260

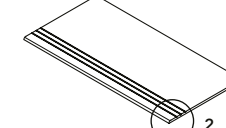
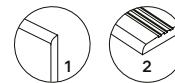

step tread grooved  
nez de marche creusé  
stufenplatte mit rillen  
degrau sulcado  
30x60 . 12"x24"  
NR MP-6240  
30x90 . 12"x36"  
NR MP-6430

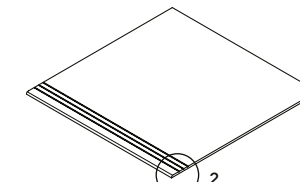

step tread grooved  
nez de marche creusé  
stufenplatte mit rillen  
degrau sulcado  
60x60 . 24"x24"  
NR MP-6400

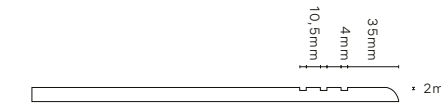

8,5MM

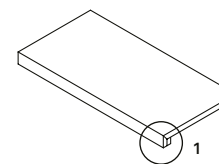

step extra thick  
nez de marche forte épaisseur  
massive stufenplatte  
degrau espessurado  
30x60 . 12"x24"  
NR MP-6560

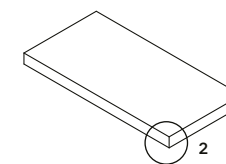
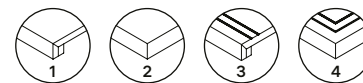

step extra thick corner\*  
nez de marche forte épaisseur angle\*  
ecke massive stufenplatte\*  
degrau espessurado canto\*  
30x60 . 12"x24"  
NR MP-6630

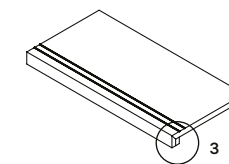

step extra thick inox  
nez de marche forte épaisseur inox  
massive stufenplatte inox  
degrau espessurado inox  
30x60 . 12"x24"  
NR MP-6580

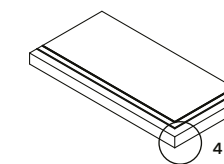

step extra thick corner inox\*  
nez de marche forte épaisseur angle inox\*  
ecke massive stufenplatte inox\*  
degrau espessurado canto inox\*  
30x60 . 12"x24"  
NR MP-6650

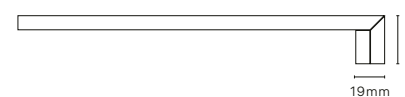

step extra thick corner . nez de marche forte épaisseur angle  
ecke massive stufenplatte . degrau espessurado canto

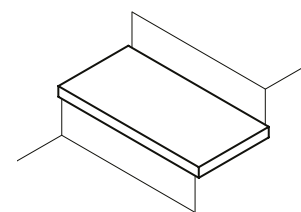

right corner . angle droit  
rechten ecke . canto direito

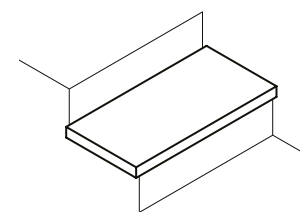

left corner . angle gauche  
links ecke . canto esquerdo



step extra thick corner inox . nez de marche forte épaisseur angle inox  
ecke massive stufenplatte inox . degrau espessurado canto inox

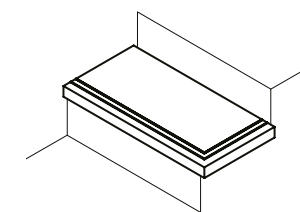

right corner . angle droit  
rechten ecke . canto direito

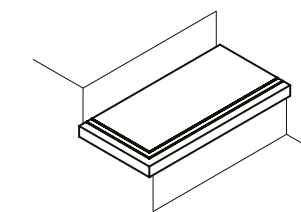

left corner . angle gauche  
links ecke . canto esquerdo

Available in all colours  
Disponible dans toutes les couleurs  
Erhältlich in allen Farben  
Disponível em todas as cores

\*Available in right and left corner  
\*Disponible dans les coin droit et gauche  
\*Erhältlich in der rechten Ecke und links  
\*Disponível no canto direito e esquerdo

Mosaic decor is net mounted. All decors may feature shade variations regarding the corresponding floor/wall tile standard tile.  
La décoration Mosaic est sur trame. Toutes les décorations peuvent souffrir variations de tonalité par rapport aux carreaux base.  
Die Mosaic Dekoration ist netzverklebt. Alle Dekorationen können im Vergleich zu den jeweiligen Grundiesen Farbunterschiede aufweisen.  
A decoração Mosaic é sobre rede. Todas as decorações podem sofrer variações de tonalidade em relação aos respectivos mosaicos base.

**MARGRES**  
CERAMIC TILES

index

colour map

collections

concept

edge

endless

evoke

extreme

grove

hybrid

jungle

natural

prestige

pure stone

slabstone

subway

tecnica

time 2.0

tool

underground

linea collections

useful information





170

general catalogue . 2023

grey SL5 60x60 NR

LAMINATED  
PORCELAIN  
STONEWARE

FULL BODY  
PORCELAIN

# slabstone

collection

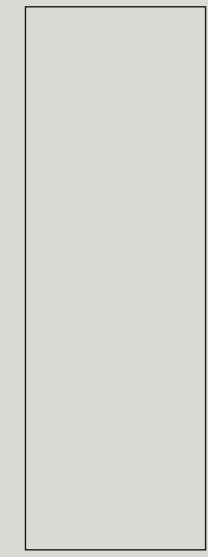

100x300  
NR 3,5mm

↓  
DOWNLOAD  
CATALOGUE

↓  
DOWNLOAD  
TECHNICAL  
FEATURES

🌐  
VIEW  
ONLINE

↓  
DOWNLOAD  
CATALOGUE  
OUTDOOR  
EXTRA THICK

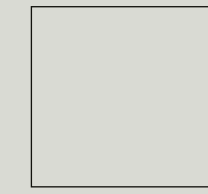

100x100  
NR 3,5mm



50x100  
NR 3,5mm

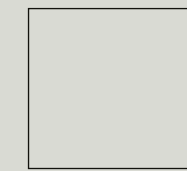

90x90  
NR 9,5mm  
ASR 9,5mm



45x90  
NR 9mm



60x60  
NR 8,5mm  
A 8,5mm  
ASR 8,5mm  
E ASR 20mm

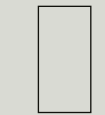

30x60  
NR 8,5mm

rectified products . produits rectifiés . rektifizierte produkte . produtos retificados



white  
SL1 . LSL1

beige  
SL2 . LSL2

tortora  
SL3 . LSL3

light grey  
SL4 . LSL4

grey  
SL5 . LSL5

UGL V2 R11 R10 R9 LINEA



pour plus d'informations, consultez  
<https://evaluation.cstb.fr>

PR( )TECT®  
Antibacterial for Life.

MARGRES  
CERAMIC TILES

171

general catalogue . 2023

index

colour map

## collections

concept

edge

endless

evoke

extreme

grove

hybrid

jungle

natural

prestige

pure stone

**slabstone**

subway

tecnica

time 2.0

tool

underground

linea collections

useful information





172

general catalogue . 2023



173

general catalogue . 2023





slabstone  
collection



174

general catalogue . 2023



slabstone  
collection

175

general catalogue . 2023

index

colour map

collections

concept

edge

endless

evoke

extreme

grove

hybrid

jungle

natural

prestige

pure stone

**slabstone**

subway

tecnica

time 2.0

tool

underground

linea collections

useful information

beige SL2 90x90 NR





176

general catalogue . 2023

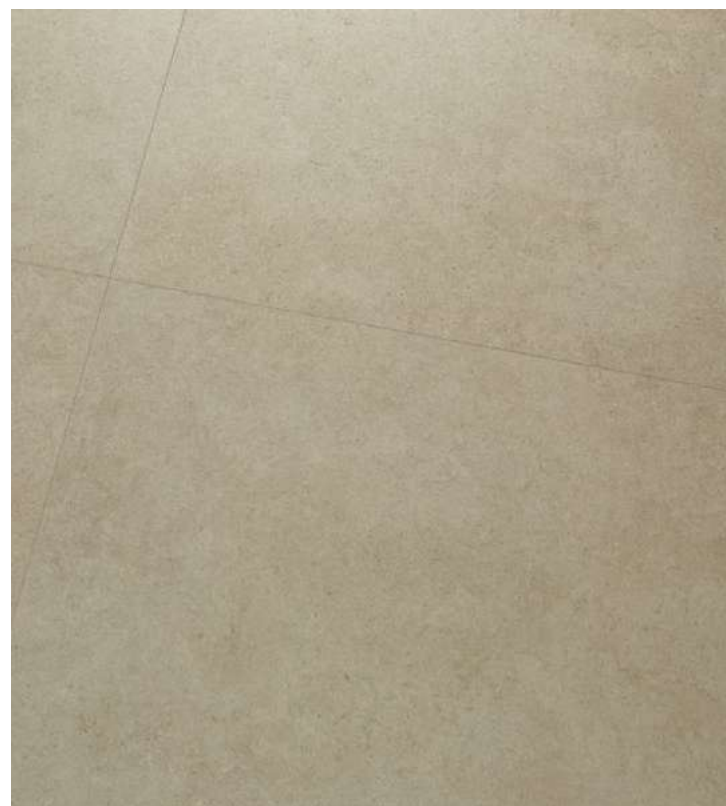

177

general catalogue . 2023









180  
general catalogue, 2023

light grey SL4 60x60 ASR - 60x60 E ASR



181  
general catalogue, 2023

beige SL2 60x60 E ASR

index

colour map

collections

concept

edge

endless

evoke

extreme

grove

hybrid

jungle

natural

prestige

pure stone

**slabstone**

subway

tecnica

time 2.0

tool

underground

linea collections

useful information



slabstone  
collection

white SL1 . LSL1 A NR ASR . E ASR



30x60 . 12"x24"	8,5mm	NR	R10	MG-2070
	8,5mm	NR	R10	MG-2780
60x60 . 24"x24"	8,5mm	A	-	MG-3095
	8,5mm	ASR	R11	MG-2780
	20mm	E ASR	R11	MG-7090
45x90 . 18"x36"	9mm	NR	R10	MG-3580
90x90 . 36"x36"	9,5mm	NR	R10	MG-3970
	9,5mm	ASR	R11	MG-3970

LINEA

50x100 . 19,6"x39,4"	3,5mm	NR	R9	M3-0930
100x100 . 39,4"x39,4"	3,5mm	NR	R9	M3-1230
100x300 . 39,4"x118"	3,5mm	NR	R9	M3-1530

beige SL2 . LSL2 A NR ASR . E ASR



30x60 . 12"x24"	8,5mm	NR	R10	MG-2070
	8,5mm	NR	R10	MG-2780
60x60 . 24"x24"	8,5mm	A	-	MG-3095
	8,5mm	ASR	R11	MG-2780
	20mm	E ASR	R11	MG-7090
45x90 . 18"x36"	9mm	NR	R10	MG-3580
90x90 . 36"x36"	9,5mm	NR	R10	MG-3970
	9,5mm	ASR	R11	MG-3970

LINEA

50x100 . 19,6"x39,4"	3,5mm	NR	R9	M3-0930
100x100 . 39,4"x39,4"	3,5mm	NR	R9	M3-1230
100x300 . 39,4"x118"	3,5mm	NR	R9	M3-1530

tortora SL3 . LSL3 A NR ASR . E ASR



30x60 . 12"x24"	8,5mm	NR	R10	MG-2070
	8,5mm	NR	R10	MG-2780
60x60 . 24"x24"	8,5mm	A	-	MG-3095
	8,5mm	ASR	R11	MG-2780
	20mm	E ASR	R11	MG-7090
45x90 . 18"x36"	9mm	NR	R10	MG-3580
90x90 . 36"x36"	9,5mm	NR	R10	MG-3970
	9,5mm	ASR	R11	MG-3970

LINEA

50x100 . 19,6"x39,4"	3,5mm	NR	R9	M3-0930
100x100 . 39,4"x39,4"	3,5mm	NR	R9	M3-1230
100x300 . 39,4"x118"	3,5mm	NR	R9	M3-1530

slabstone  
collection

ASR . E ASR NR A light grey SL4 . LSL4



30x60 . 12"x24"	8,5mm	NR	R10	MG-2070
	8,5mm	NR	R10	MG-2780
60x60 . 24"x24"	8,5mm	A	-	MG-3095
	8,5mm	ASR	R11	MG-2780
	20mm	E ASR	R11	MG-7090
45x90 . 18"x36"	9mm	NR	R10	MG-3580
90x90 . 36"x36"	9,5mm	NR	R10	MG-3970
	9,5mm	ASR	R11	MG-3970

LINEA

50x100 . 19,6"x39,4"	3,5mm	NR	R9	M3-0930
100x100 . 39,4"x39,4"	3,5mm	NR	R9	M3-1230
100x300 . 39,4"x118"	3,5mm	NR	R9	M3-1530

ASR . E ASR NR A grey SL5 . LSL5



30x60 . 12"x24"	8,5mm	NR	R10	MG-2070
	8,5mm	NR	R10	MG-2780
60x60 . 24"x24"	8,5mm	A	-	MG-3095
	8,5mm	ASR	R11	MG-2780
	20mm	E ASR	R11	MG-7090
45x90 . 18"x36"	9mm	NR	R10	MG-3580
90x90 . 36"x36"	9,5mm	NR	R10	MG-3970
	9,5mm	ASR	R11	MG-3970

LINEA

50x100 . 19,6"x39,4"	3,5mm	NR	R9	M3-0930
100x100 . 39,4"x39,4"	3,5mm	NR	R9	M3-1230
100x300 . 39,4"x118"	3,5mm	NR	R9	M3-1530



## slabstone

collection

### decors

décorations . dekorationen . decorações

8,5MM



mosaic slabstone 3,5x3,5  
white  
30x30 . 12"x12"  
NR MG-9590

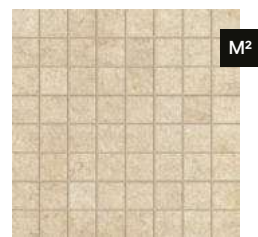

mosaic slabstone 3,5x3,5  
beige  
30x30 . 12"x12"  
NR MG-9590



mosaic slabstone 3,5x3,5  
tortora  
30x30 . 12"x12"  
NR MG-9590



mosaic slabstone 3,5x3,5  
light grey  
30x30 . 12"x12"  
NR MG-9590



mosaic slabstone 3,5x3,5  
grey  
30x30 . 12"x12"  
NR MG-9590

8,5MM



bricks slabstone white  
29,6x49 . 11,7"x19,3"  
NR MP-6320



bricks slabstone beige  
29,6x49 . 11,7"x19,3"  
NR MP-6320



bricks slabstone tortora  
29,6x49 . 11,7"x19,3"  
NR MP-6320



bricks slabstone light grey  
29,6x49 . 11,7"x19,3"  
NR MP-6320



bricks slabstone grey  
29,6x49 . 11,7"x19,3"  
NR MP-6320

Mosaic and Bricks decors are net mounted. All decors may feature shade variations regarding the corresponding floor/wall tile standard tile.  
Les décorations Mosaic et Bricks sont sur trame. Toutes les décorations peuvent souffrir variations de tonalité par rapport aux carreaux base.  
Die Mosaic und Bricks Dekoration liegen auf einem Netz. Alle Dekorationen können im Vergleich zu den jeweiligen Grundiesen Farbunterschiede aufweisen.  
As decorações Mosaic e Bricks são sobre rede. Todas as decorações podem sofrer variações de tonalidade em relação aos respectivos mosaicos base.

**MARGRES**  
CERAMIC TILES

## slabstone

collection

### special pieces

pièces spéciales . spezialteile . peças especiais

9,5 . 8,5MM

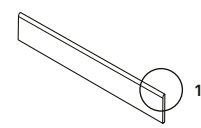

skirting  
plinthe  
sockel  
rodapé boleado

8x60 . 3,2"x24"

NR MP-6170

A MP-6180

8x90 . 3,2"x36"

NR MP-6260

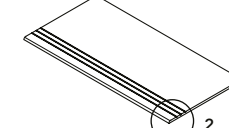
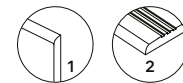

step tread grooved  
nez de marche creusé  
stufenplatte mit rillen  
degrau sulcado

30x60 . 12"x24"

NR . ASR MP-6240

A MP-6270

30x90 . 12"x36"

NR . ASR MP-6430

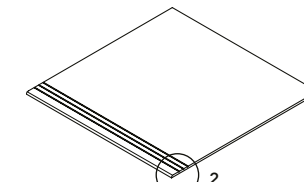

step tread grooved  
nez de marche creusé  
stufenplatte mit rillen  
degrau sulcado

60x60 . 24"x24"

NR . ASR MP-6400

A MP-6430

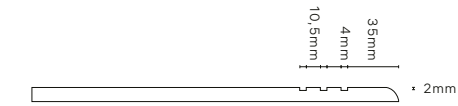

8,5MM

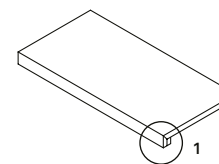

step extra thick  
nez de marche forte épaisseur  
massive stufenplatte  
degrau espessurado

30x60 . 12"x24"

NR . A MP-6560

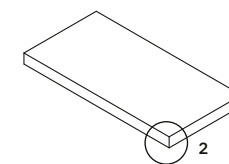
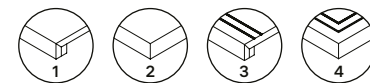

step extra thick corner\*  
nez de marche forte épaisseur angle\*  
ecke massive stufenplatte\*  
degrau espessurado canto\*

30x60 . 12"x24"

NR . A MP-6630

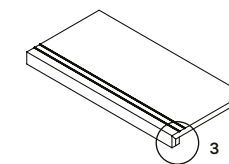

step extra thick inox  
nez de marche forte épaisseur inox  
massive stufenplatte inox  
degrau espessurado inox

30x60 . 12"x24"

NR . A MP-6580

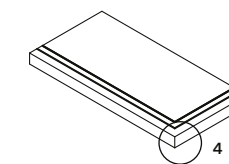

step extra thick corner inox\*  
nez de marche forte épaisseur angle inox\*  
ecke massive stufenplatte inox\*  
degrau espessurado canto inox\*

30x60 . 12"x24"

NR . A MP-6650

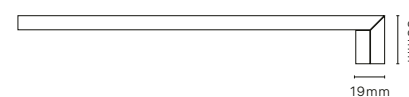

step extra thick corner . nez de marche forte épaisseur angle  
ecke massive stufenplatte . degrau espessurado canto

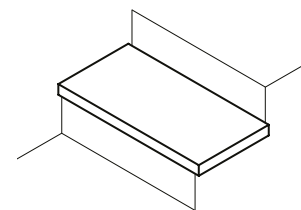

right corner . angle droit  
rechten ecke . canto direito

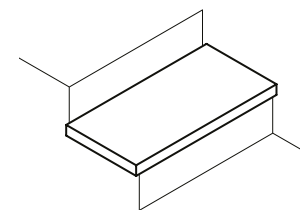

left corner . angle gauche  
links ecke . canto esquerdo

Available in all colours  
Disponible dans toutes les couleurs  
Erhältlich in allen Farben  
Disponível em todas as cores

\*Available in right and left corner  
\*Disponible dans les coin droit et gauche  
\*Erhältlich in der rechten Ecke und links  
\*Disponível no canto direito e esquerdo



step extra thick corner inox . nez de marche forte épaisseur angle inox  
ecke massive stufenplatte inox . degrau espessurado canto inox

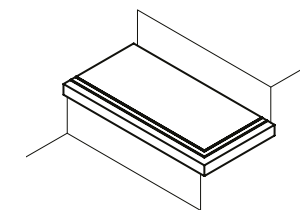

right corner . angle droit  
rechten ecke . canto direito

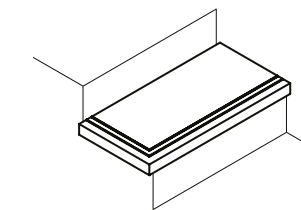

left corner . angle gauche  
links ecke . canto esquerdo

185

general catalogue . 2023

index

colour map

collections

concept

edge

endless

evoke

extreme

grove

hybrid

jungle

natural

prestige

pure stone

slabstone

subway

tecnica

time 2.0

tool

underground

linea collections

useful information





wenge NT6 20x90 K

DIGITEK  
PORCELAIN  
STONEWARE

# natural

collection



DOWNLOAD  
CATALOGUE



DOWNLOAD  
TECHNICAL  
FEATURES



VIEW  
ONLINE



20x90  
N 9mm  
K 9mm  
SL 9mm

non-rectified product . produit non rectifié . nicht rektifiziert produkt . produto não retificado



white NT1    cream NT2    grey NT3    tortora NT4    brown NT5    wenge NT6

UGL V2 R11 R9

**MARGRES**  
CERAMIC TILES

index

colour map

collections

concept

edge

endless

evoke

extreme

grove

hybrid

jungle

natural

prestige

pure stone

slabstone

subway

tecnica

time 2.0

tool

underground

linea collections

useful information



**natural**  
collection

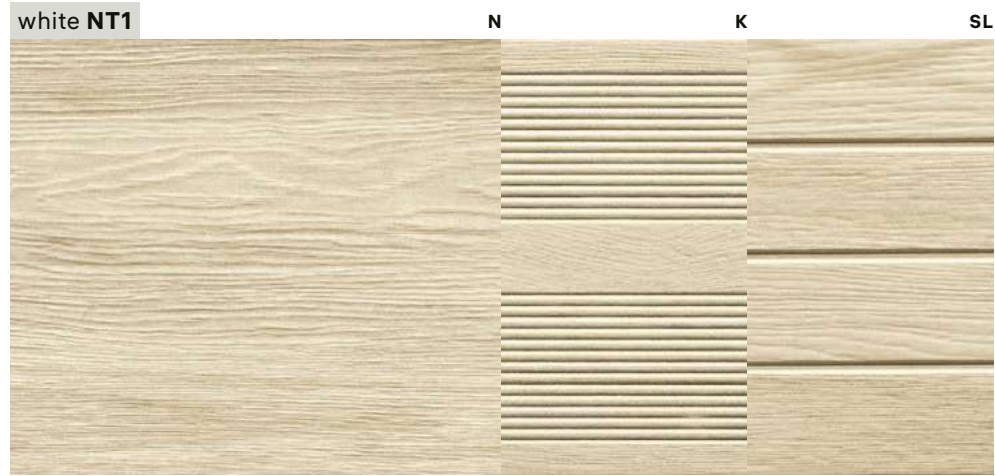

20x90 . 8"x36"	9mm	<b>N</b>	R9	MG-1130
	9mm	<b>K</b>	R11	MG-1160
	9mm	<b>SL</b>	R9	MG-1160

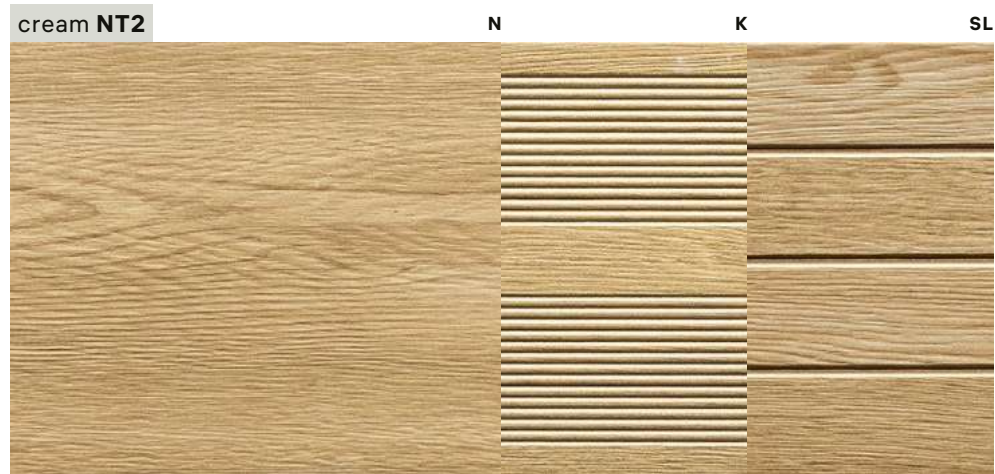

20x90 . 8"x36"	9mm	<b>N</b>	R9	MG-1130
	9mm	<b>K</b>	R11	MG-1160
	9mm	<b>SL</b>	R9	MG-1160

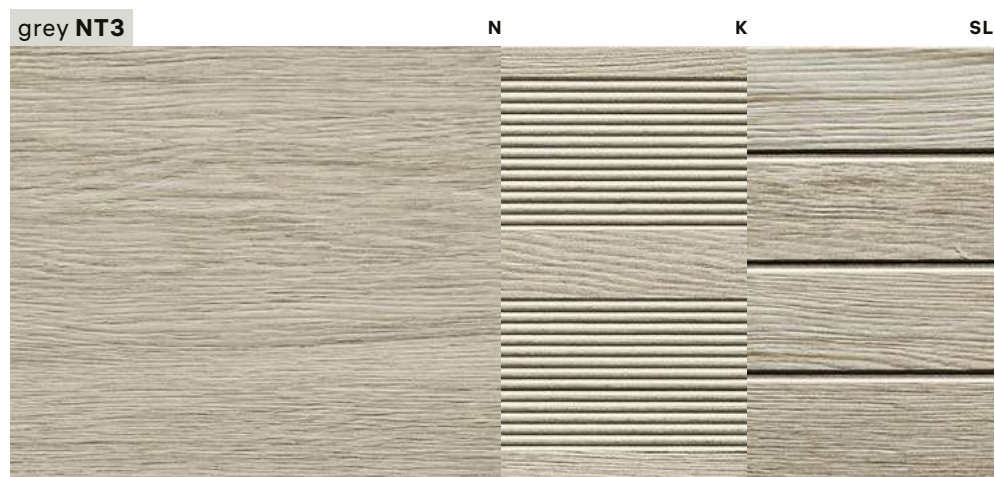

20x90 . 8"x36"	9mm	<b>N</b>	R9	MG-1130
	9mm	<b>K</b>	R11	MG-1160
	9mm	<b>SL</b>	R9	MG-1160

**natural**  
collection

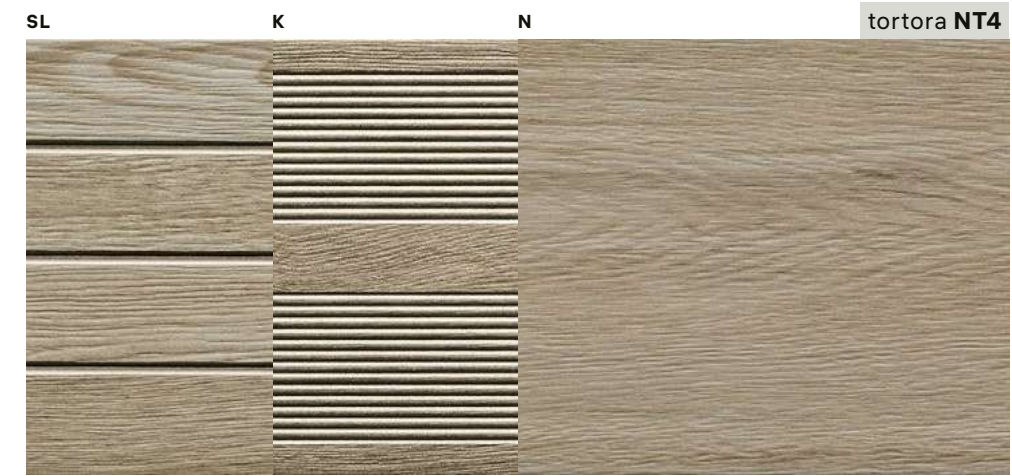

20x90 . 8"x36"	9mm	<b>N</b>	R9	MG-1130
	9mm	<b>K</b>	R11	MG-1160
	9mm	<b>SL</b>	R9	MG-1160

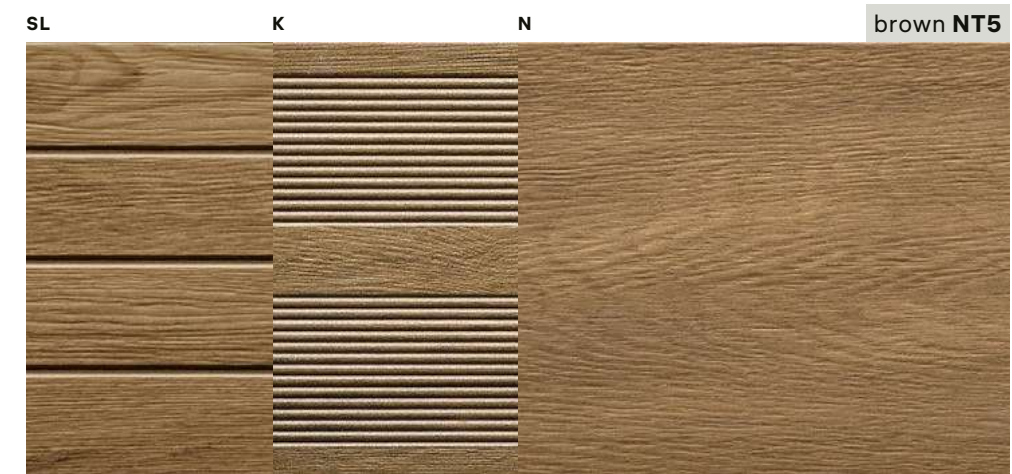

20x90 . 8"x36"	9mm	<b>N</b>	R9	MG-1130
	9mm	<b>K</b>	R11	MG-1160
	9mm	<b>SL</b>	R9	MG-1160

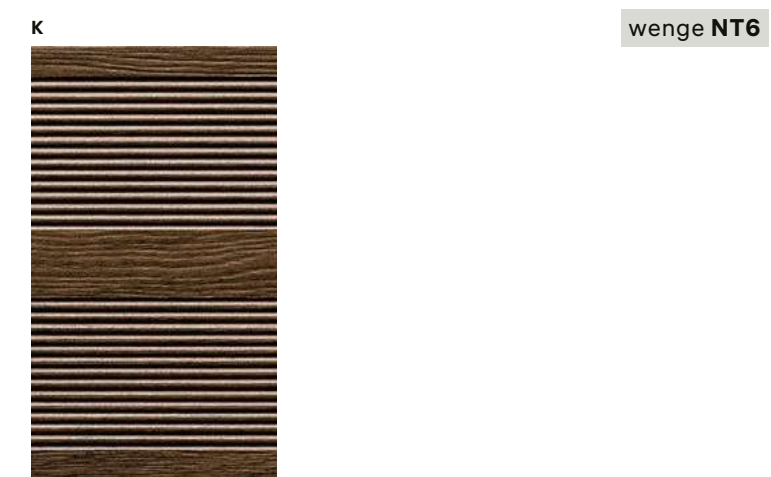

20x90 . 8"x36"	9mm	<b>K</b>	R11	MG-1160
----------------	-----	----------	-----	---------

188  
general catalogue . 2023

189  
general catalogue . 2023

**laying suggestions**

suggestions de pose . anwendungsvorschläge . sugestões de aplicação

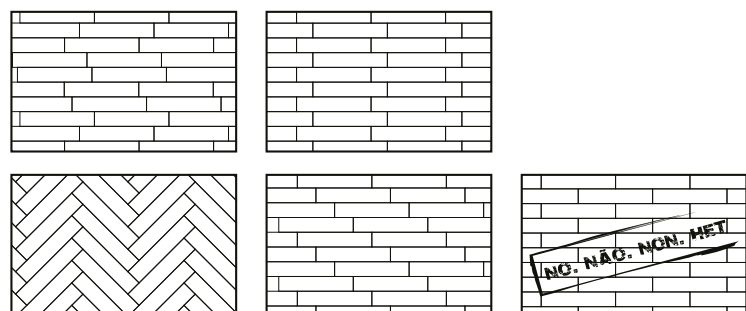

**special pieces**

pièces spéciales . spezialteile . peças especiais

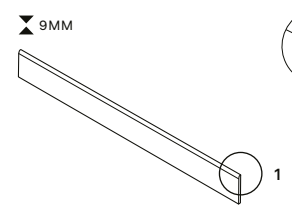

skirting  
plinthe  
sockel  
rodapé boleado  
9,5x90 . 3,8"x36"  
**N** MP-6200

Available in all colours with the exception of Wenge  
Disponible dans toutes les couleurs excepté le couleur Wenge  
Erhältlich in allen Farben außer Wenge  
Disponível em todas as cores exceto na cor Wenge

**MARGRES**  
CERAMIC TILES

index

colour map

collections

concept

edge

endless

evoke

extreme

grove

hybrid

jungle

**natural**

prestige

pure stone

slabstone

subway

tecnica

time 2.0

tool

underground

linea collections

useful information





ash SW2 90x90 NR

LAMINATED  
PORCELAIN  
STONEWARE

FULL BODY  
PORCELAIN

**subway**  
collection



100x300  
NR 3,5mm

↓  
DOWNLOAD  
CATALOGUE

↓  
DOWNLOAD  
TECHNICAL  
FEATURES

🌐  
VIEW  
ONLINE

↓  
DOWNLOAD  
CATALOGUE  
OUTDOOR  
EXTRA THICK

▶  
ENJOY THE  
VIDEO

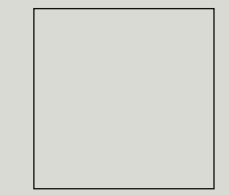

100x100  
NR 3,5mm



50x100  
NR 3,5mm

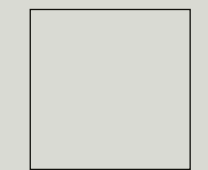

90x90  
NR 9,5mm

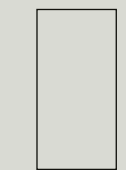

45x90  
NR 9mm



60x60  
NR 8,5mm  
A 8,5mm  
E ASR 20mm



30x60  
NR 8,5mm

rectified products . produits rectifiés . rektifizierte produkte . produtos retificados



white  
SW1 . LSW1

ash  
SW2 . LSW2

clay  
SW3 . LSW3

smoke  
SW4 . LSW4

UGL V2 R10 R9 LINEA

**PR( )TECT®**  
Antibacterial for Life.

**MARGRES**  
CERAMIC TILES

index

colour map

collections

concept

edge

endless

evoke

extreme

grove

hybrid

jungle

natural

prestige

pure stone

slabstone

subway

tecnica

time 2.0

tool

underground

linea collections

useful information



subway  
collection



192

general catalogue . 2023



subway  
collection



193

general catalogue . 2023

white SW1 45x90 NR

index

colour map

collections

concept

edge

endless

evoke

extreme

grove

hybrid

jungle

natural

prestige

pure stone

slabstone

subway

tecnica

time 2.0

tool

underground

linea collections

useful information





194

general catalogue . 2023

smoke SW4 90x90 NR

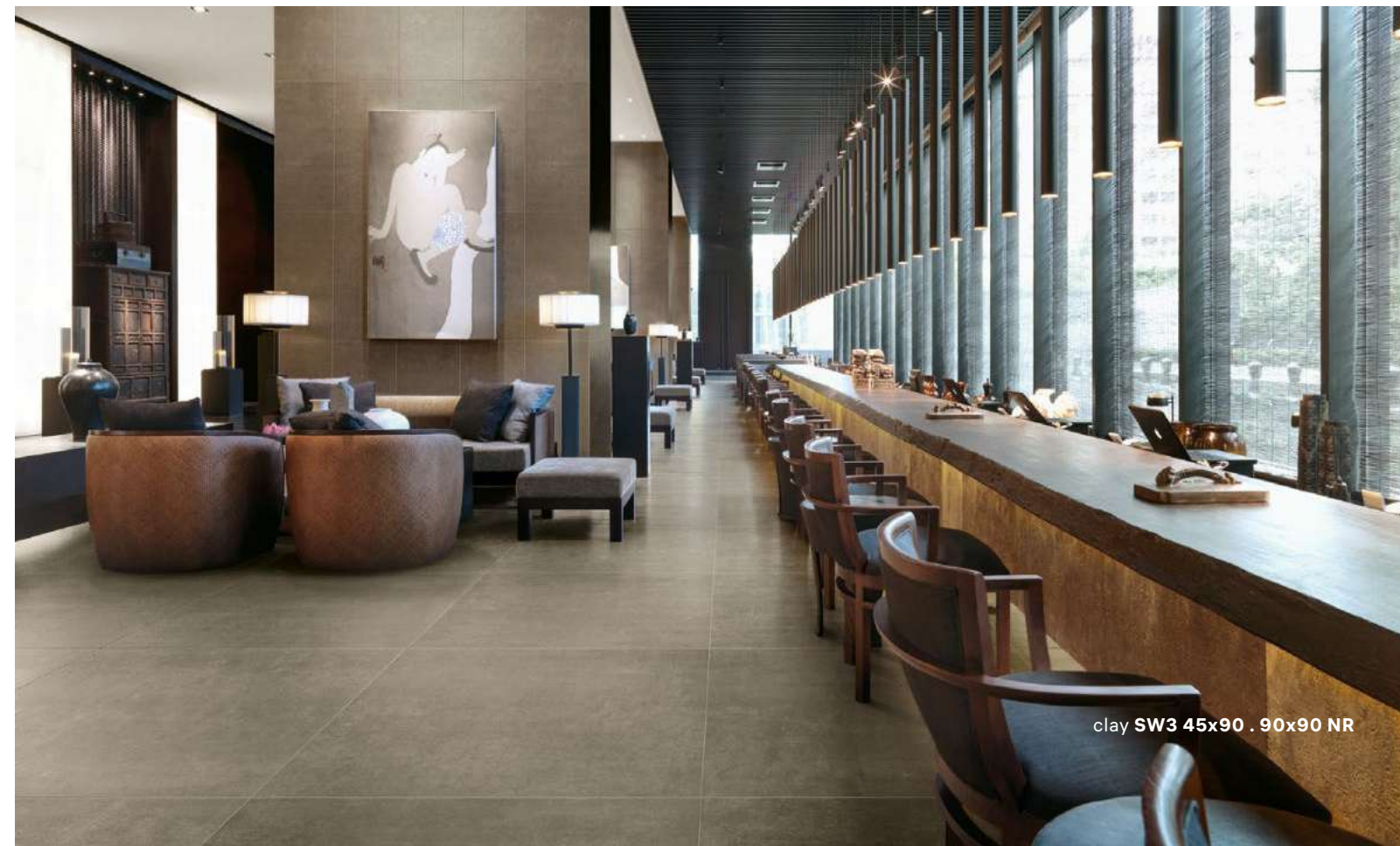

195

general catalogue . 2023

clay SW3 45x90 . 90x90 NR

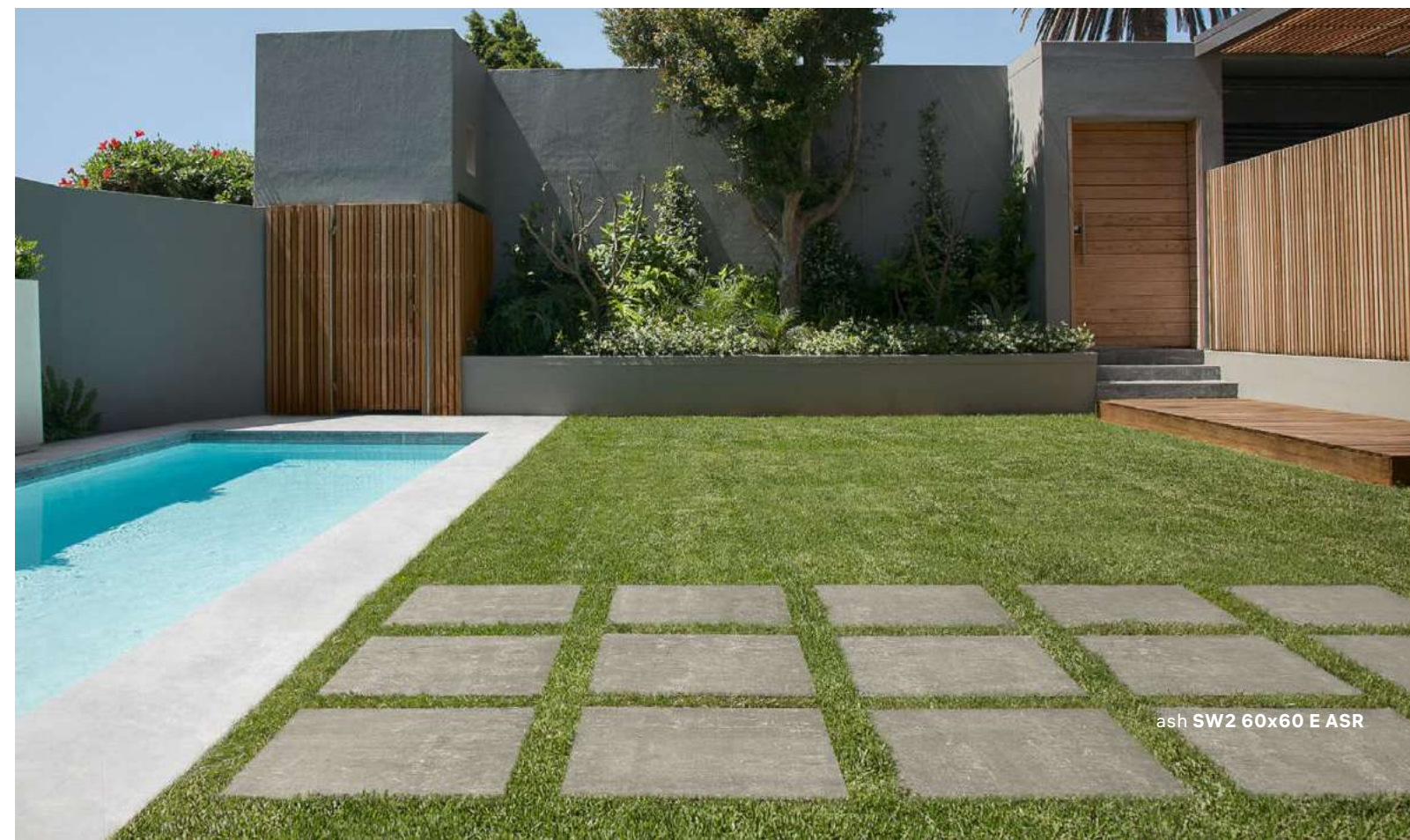

ash SW2 60x60 E ASR

index

colour map

collections

concept

edge

endless

evoke

extreme

grove

hybrid

jungle

natural

prestige

pure stone

slabstone

subway

tecnica

time 2.0

tool

underground

linea collections

useful information



white SW1 . LSW1 A NR E ASR



30x60 . 12"x24"	8,5mm	NR	R9	MG-2095
	8,5mm	NR	R9	MG-2765
60x60 . 24"x24"	8,5mm	A	-	MG-3070
	20mm	E ASR	R10	MG-7090
45x90 . 18"x36"	9mm	NR	R9	MG-3560
90x90 . 36"x36"	9,5mm	NR	R9	MG-3960

LINEA

50x100 . 19,6"x39,4"	3,5mm	NR	R9	M3-0930
100x100 . 39,4"x39,4"	3,5mm	NR	R9	M3-1230
100x300 . 39,4"x118"	3,5mm	NR	R9	M3-1530

clay SW3 . LSW3 A NR E ASR

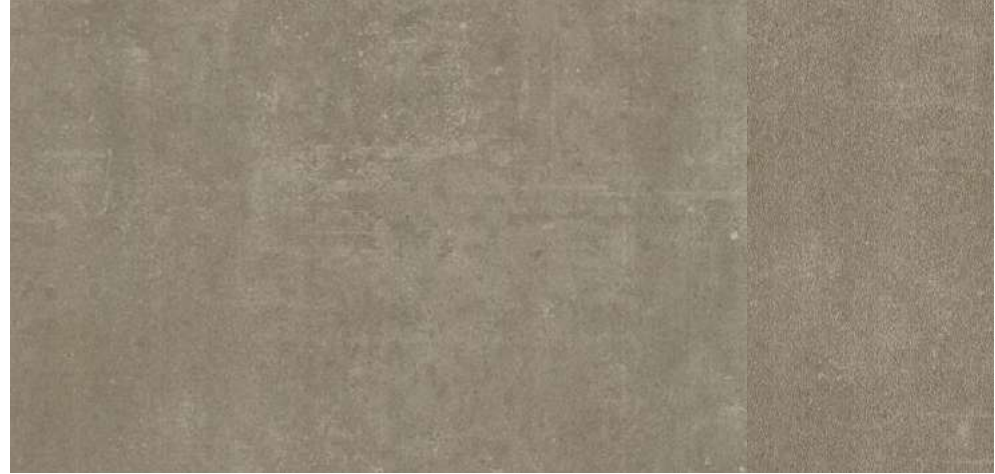

30x60 . 12"x24"	8,5mm	NR	R9	MG-2095
	8,5mm	NR	R9	MG-2765
60x60 . 24"x24"	8,5mm	A	-	MG-3070
	20mm	E ASR	R10	MG-7090
45x90 . 18"x36"	9mm	NR	R9	MG-3560
90x90 . 36"x36"	9,5mm	NR	R9	MG-3960

LINEA

50x100 . 19,6"x39,4"	3,5mm	NR	R9	M3-0930
100x100 . 39,4"x39,4"	3,5mm	NR	R9	M3-1230
100x300 . 39,4"x118"	3,5mm	NR	R9	M3-1530

E ASR NR A ash SW2 . LSW2



30x60 . 12"x24"	8,5mm	NR	R9	MG-2095
	8,5mm	NR	R9	MG-2765
60x60 . 24"x24"	8,5mm	A	-	MG-3070
	20mm	E ASR	R10	MG-7090
45x90 . 18"x36"	9mm	NR	R9	MG-3560
90x90 . 36"x36"	9,5mm	NR	R9	MG-3960

LINEA

50x100 . 19,6"x39,4"	3,5mm	NR	R9	M3-0930
100x100 . 39,4"x39,4"	3,5mm	NR	R9	M3-1230
100x300 . 39,4"x118"	3,5mm	NR	R9	M3-1530

E ASR NR A smoke SW4 . LSW4



30x60 . 12"x24"	8,5mm	NR	R9	MG-2095
	8,5mm	NR	R9	MG-2765
60x60 . 24"x24"	8,5mm	A	-	MG-3070
	20mm	E ASR	R10	MG-7090
45x90 . 18"x36"	9mm	NR	R9	MG-3560
90x90 . 36"x36"	9,5mm	NR	R9	MG-3960

LINEA

50x100 . 19,6"x39,4"	3,5mm	NR	R9	M3-0930
100x100 . 39,4"x39,4"	3,5mm	NR	R9	M3-1230
100x300 . 39,4"x118"	3,5mm	NR	R9	M3-1530



## subway

collection

### decors

décorations . dekorationen . decorações

8,5MM



mosaic subway 3,5x3,5 white  
30x30 . 12"x12"  
NR MG-9590



mosaic subway 3,5x3,5 ash  
30x30 . 12"x12"  
NR MG-9590



mosaic subway 3,5x3,5 clay  
30x30 . 12"x12"  
NR MG-9590



mosaic subway 3,5x3,5 smoke  
30x30 . 12"x12"  
NR MG-9590

8,5MM



bricks subway white  
29,6x59,5 . 11,7"x23,4"  
NR MP-6350



bricks subway ash  
29,6x59,5 . 11,7"x23,4"  
NR MP-6350



bricks subway clay  
29,6x59,5 . 11,7"x23,4"  
NR MP-6350



bricks subway smoke  
29,6x59,5 . 11,7"x23,4"  
NR MP-6350

### special pieces

pièces spéciales . spezialteile . peças especiais

9,5 . 8,5MM

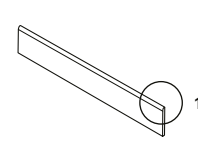

skirting  
plinthe  
rodapé boleado

8x60 . 3,2"x24"

NR MP-6170  
A MP-6180

8x90 . 3,2"x36"

NR MP-6260

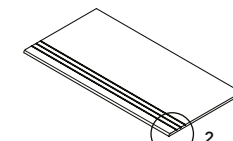
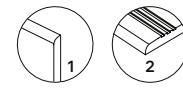

step tread grooved  
nez de marche creusé  
stufenplatte mit rillen  
degrau sulcado

30x60 . 12"x24"

NR MP-6240  
A MP-6270

30x90 . 12"x36"

NR MP-6430

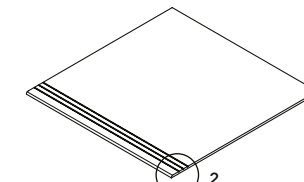

step tread grooved  
nez de marche creusé  
stufenplatte mit rillen  
degrau sulcado

60x60 . 24"x24"

NR MP-6400  
A MP-6430

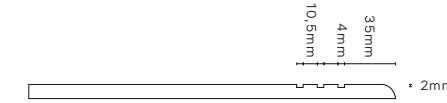

8,5MM

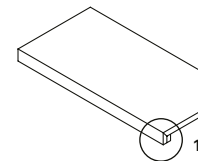

step extra thick  
nez de marche forte épaisseur  
massive stufenplatte  
degrau espessurado

30x60 . 12"x24"

NR . A MP-6560

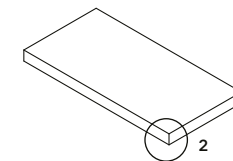
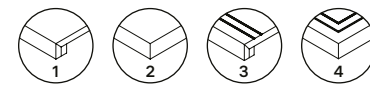

step extra thick corner\*  
nez de marche forte épaisseur angle\*  
ecke massive stufenplatte\*  
degrau espessurado canto\*

30x60 . 12"x24"

NR . A MP-6630

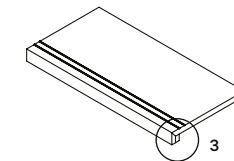

step extra thick inox  
nez de marche forte épaisseur inox  
massive stufenplatte inox  
degrau espessurado inox

30x60 . 12"x24"

NR . A MP-6580

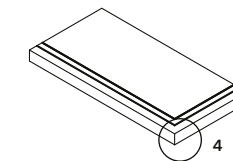

step extra thick corner inox\*  
nez de marche forte épaisseur angle inox\*  
ecke massive stufenplatte inox\*  
degrau espessurado canto inox\*

30x60 . 12"x24"

NR . A MP-6650

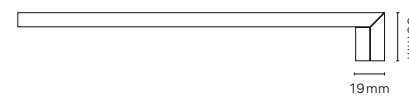

step extra thick corner . nez de marche forte épaisseur angle  
ecke massive stufenplatte . degrau espessurado canto

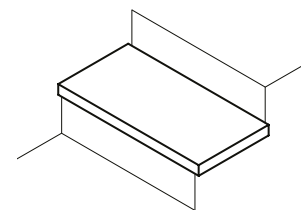

right corner . angle droit  
rechten ecke . canto direito

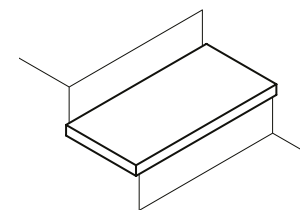

left corner . angle gauche  
links ecke . canto esquerdo



step extra thick corner inox . nez de marche forte épaisseur angle inox  
ecke massive stufenplatte inox . degrau espessurado canto inox

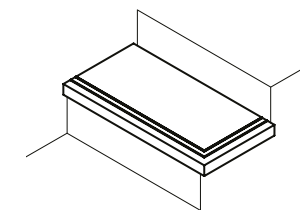

right corner . angle droit  
rechten ecke . canto direito

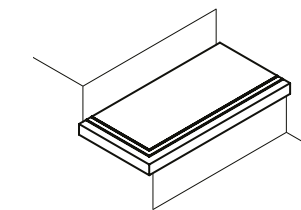

left corner . angle gauche  
links ecke . canto esquerdo

Mosaic and Brick decors are net mounted. All decors may feature shade variations regarding the corresponding floor/wall tile standard tile.

Les décorations Mosaic et Brick sont sur trame. Toutes les décorations peuvent souffrir variations de tonalité par rapport aux carreaux base.

Die Mosaic und Brick Dekoration liegen auf einem Netz. Alle Dekorationen können im Vergleich zu den jeweiligen Grundiesen Farbunterschiede aufweisen.

As decorações Mosaic and Brick são sobre rede. Todas as decorações podem sofrer variações de tonalidade em relação aos respectivos mosaicos base.

**MARGRES**  
CERAMIC TILES

Available in all colours

Disponible dans toutes les couleurs

Erhältlich in allen Farben

Disponível em todas as cores

\*Available in right and left corner

\*Disponible dans les coin droit et gauche

\*Erhältlich in der rechten Ecke und links

\*Disponível no canto direito e esquerdo

index

colour map

collections

concept

edge

endless

evoke

extreme

grove

hybrid

jungle

natural

prestige

pure stone

slabstone

subway

tecnic

time 2.0

tool

underground

linea collections

useful information





general catalogue . 2023

general catalogue . 2023

cream T23 90x90 P

**LAMINATED PORCELAIN STONEWARE**  
**TECHNICAL FULL BODY PORCELAIN**

# time 2.0

collection

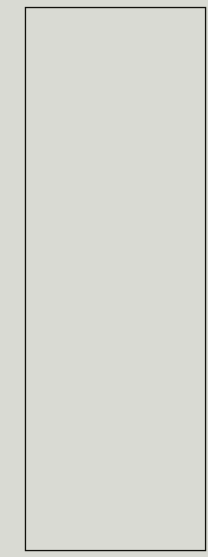

100x300  
NR 3,5mm

↓  
DOWNLOAD CATALOGUE

↓  
DOWNLOAD TECHNICAL FEATURES

🌐  
VIEW ONLINE

↓  
DOWNLOAD CATALOGUE OUTDOOR EXTRA THICK

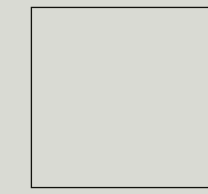

100x100  
NR 3,5mm

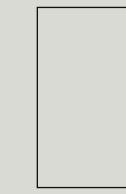

50x100  
NR 3,5mm



60x120  
NR 11mm  
P 10,5mm

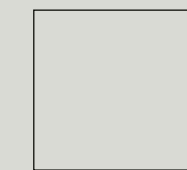

90x90  
NR 11mm  
P 10,5mm



60x60  
NR 10mm  
P 9,5mm  
ASR 10mm  
E NR 14mm



30x60  
NR 10mm  
P 9,5mm  
ASR 10mm

rectified products . produits rectifiés . rektifizierte produkte . produtos retificados



snow T21 . LT21    white T22    cream T23 . LT23    beige T24 . LT24    dove T25

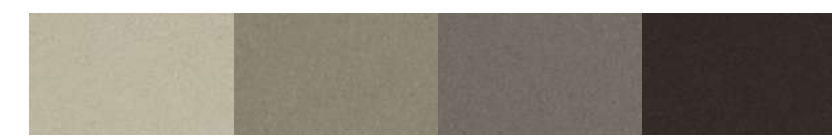

silver T26 . LT26    grey T27    carbon T28 . LT28    black T29 . LT29

**UGL** **V1** **R11** **R10** **R9** **LINEA**



**PROTECT**  
Antibacterial for Life.

pour plus d'informations, consultez <https://evaluation.cstb.fr>

**MARGRES**  
CERAMIC TILES

index

colour map

**collections**

concept

edge

endless

evoke

extreme

grove

hybrid

jungle

natural

prestige

pure stone

slabstone

subway

tecnica

**time 2.0**

tool

underground

linea collections

useful information



time 2.0  
collection



silver T26 60x60 E NR

time 2.0  
collection



silver T26 90x90 P

index

colour map

collections

concept

edge

endless

evoke

extreme

grove

hybrid

jungle

natural

prestige

pure stone

slabstone

subway

tecnica

**time 2.0**

tool

underground

linea collections

useful information

203

general catalogue, 2023



time 2.0  
collection

time 2.0  
collection

index

colour map

collections

concept

edge

endless

evoke

extreme

grove

hybrid

jungle

natural

prestige

pure stone

slabstone

subway

tecnica

**time 2.0**

tool

underground

linea collections

useful information

204

205

general catalogue . 2023

general catalogue . 2023

snow T21 60x60 P



concept

edge

endless

evoke

extreme

grove

hybrid

jungle

natural

prestige

pure stone

slabstone

subway

tecnica

**time 2.0**

tool

underground

linea collections

useful information



206

general catalogue . 2023

207

general catalogue . 2023



time 2.0  
collection



white T22 60x60 NR

208

general catalogue . 2023

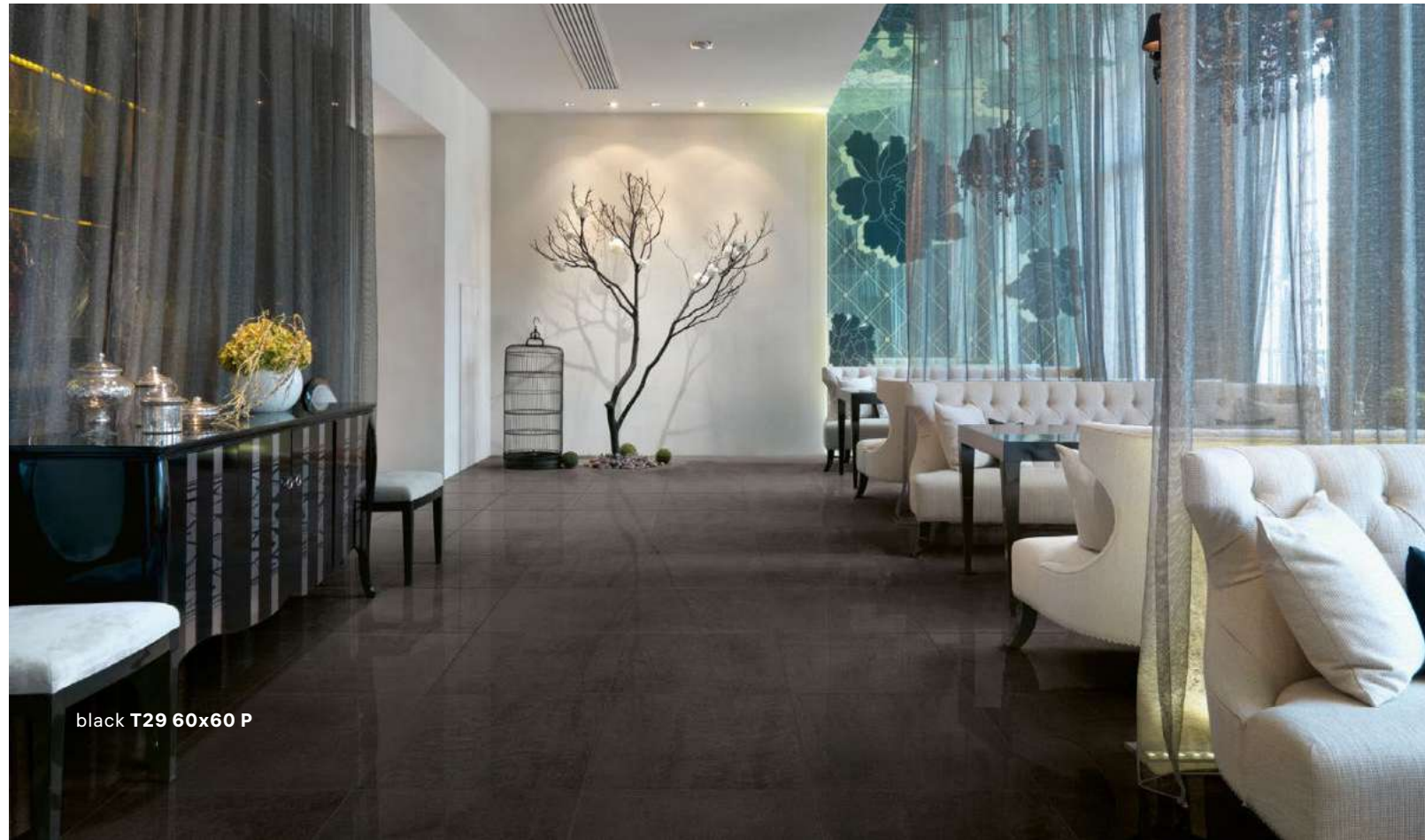

black T29 60x60 P

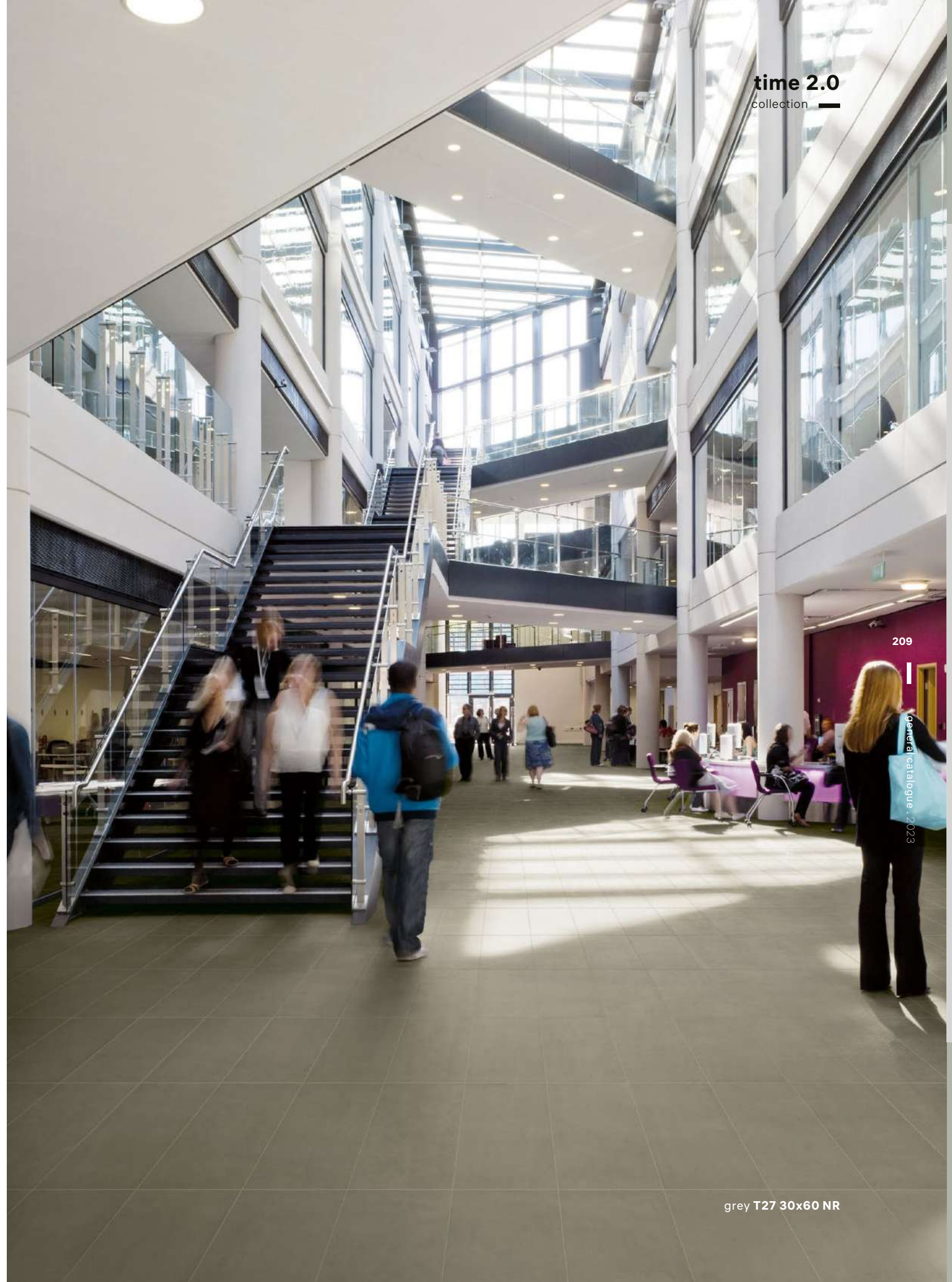

time 2.0  
collection

209

general catalogue . 2023

grey T27 30x60 NR

index

colour map

collections

concept

edge

endless

evoke

extreme

grove

hybrid

jungle

natural

prestige

pure stone

slabstone

subway

tecnica

**time 2.0**

tool

underground

linea collections

useful information





20  
General catalogue, 2023

silver T26 60x60 ASR



211  
General catalogue, 2023

grey T27 60x60 E NR

index

colour map

collections

concept

edge

endless

evoke

extreme

grove

hybrid

jungle

natural

prestige

pure stone

slabstone

subway

tecnica

**time 2.0**

tool

underground

linea collections

useful information



snow T21 . LT21 P NR . ENR ASR



30x60 . 12"x24"	10mm	NR	R10	MG-2205
	10mm	ASR	R11	MG-2205
	9,5mm	P	-	MG-2650
60x60 . 24"x24"	14mm	ENR	R10	MG-3475
	10mm	NR	R10	MG-2870
	10mm	ASR	R11	MG-2870
90x90 . 36"x36"	9,5mm	P	-	MG-3330
	11mm	NR	R10	MG-4045
	10,5mm	P	-	MG-4540
60x120 . 24"x48"	11mm	NR	R10	MG-4805
	10,5mm	P	-	MG-5250
<b>LINEA</b>				
50x100 . 19,6"x39,4"	3,5mm	NR	R9	M3-0930
100x100 . 39,4"x39,4"	3,5mm	NR	R9	M3-1230
100x300 . 39,4"x118"	3,5mm	NR	R9	M3-1530

white T22 P NR



30x60 . 12"x24"	10mm	NR	R10	MG-2105
	9,5mm	P	-	MG-2570
60x60 . 24"x24"	10mm	NR	R10	MG-2785
	9,5mm	P	-	MG-3250
60x120 . 24"x48"	11mm	NR	R10	MG-4760
	10,5mm	P	-	MG-5210

cream T23 . LT23 P NR . ENR ASR



30x60 . 12"x24"	10mm	NR	R10	MG-2105
	10mm	ASR	R11	MG-2105
	9,5mm	P	-	MG-2570
60x60 . 24"x24"	14mm	ENR	R10	MG-3425
	10mm	NR	R10	MG-2785
	10mm	ASR	R11	MG-2785
90x90 . 36"x36"	9,5mm	P	-	MG-3250
	11mm	NR	R10	MG-3985
	10,5mm	P	-	MG-4485
60x120 . 24"x48"	11mm	NR	R10	MG-4760
	10,5mm	P	-	MG-5210
<b>LINEA</b>				
50x100 . 19,6"x39,4"	3,5mm	NR	R9	M3-0930
100x100 . 39,4"x39,4"	3,5mm	NR	R9	M3-1230
100x300 . 39,4"x118"	3,5mm	NR	R9	M3-1530

ASR NR P beige T24 . LT24

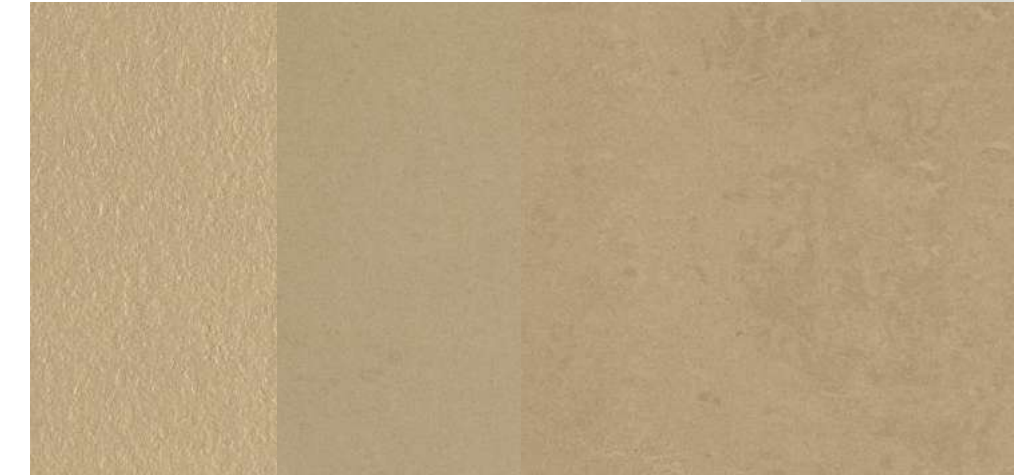

30x60 . 12"x24"	10mm	NR	R10	MG-2105
	10mm	ASR	R11	MG-2105
60x60 . 24"x24"	9,5mm	P	-	MG-2570
	10mm	NR	R10	MG-2785
	10mm	ASR	R11	MG-2785
90x90 . 36"x36"	9,5mm	P	-	MG-3250
	11mm	NR	R10	MG-3985
	10,5mm	P	-	MG-4485
<b>LINEA</b>				
50x100 . 19,6"x39,4"	3,5mm	NR	R9	M3-0930
100x100 . 39,4"x39,4"	3,5mm	NR	R9	M3-1230
100x300 . 39,4"x118"	3,5mm	NR	R9	M3-1530

NR P dove T25



30x60 . 12"x24"	10mm	NR	R10	MG-2105
	9,5mm	P	-	MG-2570
60x60 . 24"x24"	10mm	NR	R10	MG-2785
	9,5mm	P	-	MG-3250

Products with a polished finish are more sensitive to abrasion and stains, what requires special conditions. Please see page 348 in chapter 09.  
Les produits à finition polie sont plus sensibles à l'abrasion et aux taches, ce qui requiert des conditions particulières. Veuillez-vous consulter la page 348 du chapitre 09.  
Produkte mit einer polierten Oberfläche sind empfindlicher gegen Abrieb und Fleckenbildung, was besondere Bedingungen erfordert. Bitte beachten Sie Seite 348 in Kapitel 09.  
Os produtos com acabamento polido são mais sensíveis à abrasão e às manchas, o que requer condições especiais. Por favor consulte a página 348 no capítulo 09.

**PROTECT**

Antibacterial for Life.

An exclusive line of extremely high performance antimicrobial floor and wall tiles, designed for healthy, safe and protected living spaces. Available only in Linea Range.  
Une ligne exclusive de sols et revêtements antibactériens aux performances très élevées, pour un habitat sain, sûr et protégé. Disponible uniquement dans la gamme Linea.  
Eine exklusive Linie an hochwertigen Fußböden und antibakteriellen Wandverkleidungen, für ein gesundes, sicheres und geschütztes Leben. Nur in der Linea Serie erhältlich.  
Uma linha exclusiva de pavimentos e revestimentos antimicrobianos de altíssima performance, projetada para ambientes saudáveis, seguros e protegidos. Disponível unicamente na gama Linea.



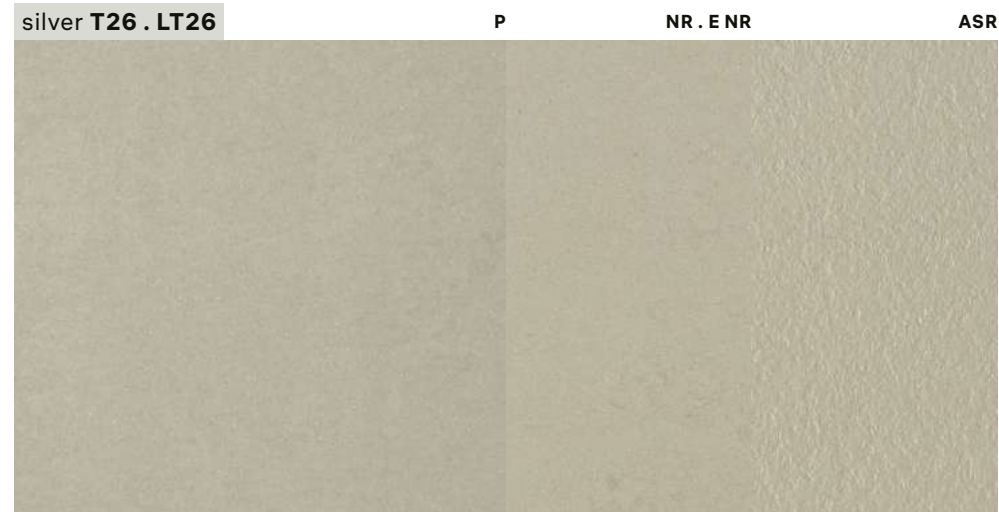

30x60 . 12"x24"	10mm	NR	R10	MG-2105
	10mm	ASR	R11	MG-2105
	9,5mm	P	-	MG-2570
60x60 . 24"x24"	14mm	ENR	R10	MG-3425
	10mm	NR	R10	MG-2785
	10mm	ASR	R11	MG-2785
90x90 . 36"x36"	9,5mm	P	-	MG-3250
	11mm	NR	R10	MG-3985
	10,5mm	P	-	MG-4485
60x120 . 24"x48"	11mm	NR	R10	MG-4760
	10,5mm	P	-	MG-5210
<b>LINEA</b>				
50x100 . 19,6"x39,4"	3,5mm	NR	R9	M3-0930
100x100 . 39,4"x39,4"	3,5mm	NR	R9	M3-1230
100x300 . 39,4"x118"	3,5mm	NR	R9	M3-1530

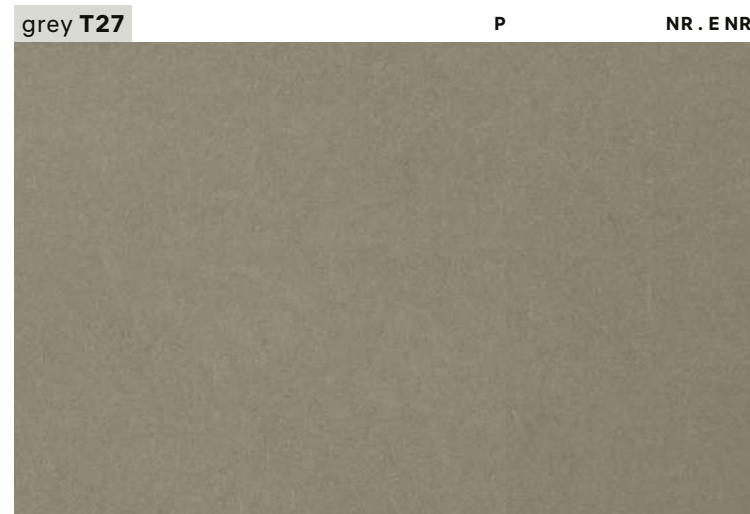

30x60 . 12"x24"	10mm	NR	R10	MG-2105
	9,5mm	P	-	MG-2570
60x60 . 24"x24"	14mm	ENR	R10	MG-3425
	10mm	NR	R10	MG-2785
	9,5mm	P	-	MG-3250
60x120 . 24"x48"	11mm	NR	R10	MG-4760
	10,5mm	P	-	MG-5210

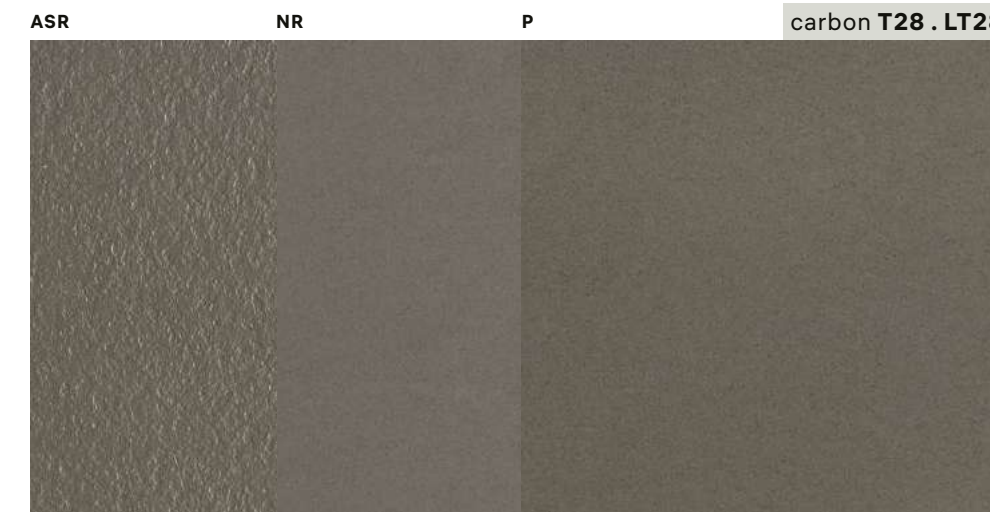

30x60 . 12"x24"	10mm	NR	R10	MG-2105
	10mm	ASR	R11	MG-2105
	9,5mm	P	-	MG-2570
60x60 . 24"x24"	10mm	NR	R10	MG-2785
	10mm	ASR	R11	MG-2785
	9,5mm	P	-	MG-3250
90x90 . 36"x36"	11mm	NR	R10	MG-3985
	10,5mm	P	-	MG-4485
<b>LINEA</b>				
50x100 . 19,6"x39,4"	3,5mm	NR	R9	M3-0930
100x100 . 39,4"x39,4"	3,5mm	NR	R9	M3-1230
100x300 . 39,4"x118"	3,5mm	NR	R9	M3-1530

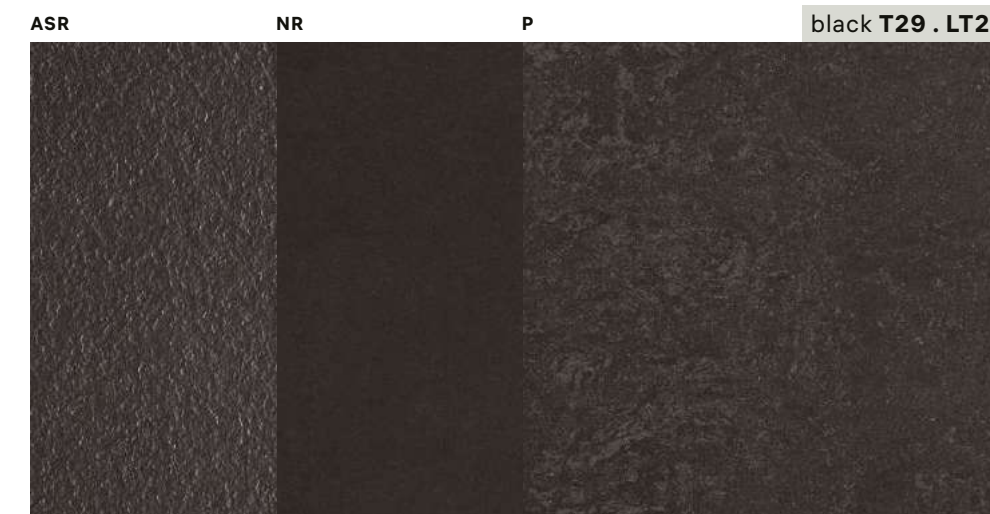

30x60 . 12"x24"	10mm	NR	R10	MG-2105
	10mm	ASR	R11	MG-2105
	9,5mm	P	-	MG-2570
60x60 . 24"x24"	10mm	NR	R10	MG-2785
	10mm	ASR	R11	MG-2785
	9,5mm	P	-	MG-3250
90x90 . 36"x36"	11mm	NR	R10	MG-3985
	10,5mm	P	-	MG-4485
60x120 . 24"x48"	11mm	NR	R10	MG-4760
	10,5mm	P	-	MG-5210
<b>LINEA</b>				
50x100 . 19,6"x39,4"	3,5mm	NR	R9	M3-0930
100x100 . 39,4"x39,4"	3,5mm	NR	R9	M3-1230
100x300 . 39,4"x118"	3,5mm	NR	R9	M3-1530

Products with a polished finish are more sensitive to abrasion and stains, what requires special conditions. Please see page 348 in chapter 09.  
 Les produits à finition polie sont plus sensibles à l'abrasion et aux taches, ce qui requiert des conditions particulières. Veuillez-vous consulter la page 348 du chapitre 09.  
 Produkte mit einer polierten Oberfläche sind empfindlicher gegen Abrieb und Fleckenbildung, was besondere Bedingungen erfordert. Bitte beachten Sie Seite 348 in Kapitel 09.  
 Os produtos com acabamento polido são mais sensíveis à abrasão e às manchas, o que requer condições especiais. Por favor consulte a página 348 no capítulo 09.

**PROTECT**  
Antibacterial for Life.

An exclusive line of extremely high performance antimicrobial floor and wall tiles, designed for healthy, safe and protected living spaces. Available only in Linea Range.  
 Une ligne exclusive de sols et revêtements antibactériens aux performances très élevées, pour un habitat sain, sûr et protégé. Disponible uniquement dans la gamme Linea.  
 Eine exklusive Linie an hochwertigen Fußböden und antibakteriellen Wandverkleidungen, für ein gesundes, sicheres und geschütztes Leben. Nur in der Linea Serie erhältlich.  
 Uma linha exclusiva de pavimentos e revestimentos antimicrobianos de altíssima performance, projetada para ambientes saudáveis, seguros e protegidos. Disponível unicamente na gama Linea.



## time 2.0

collection

### decors

décorations . dekorationen . decorações

✂ P 9,5MM . NR 10MM . ASR 10MM

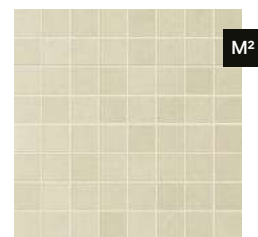

mosaic time 2.0 3,5x3,5  
(all colours)  
**30x30** . 12"x12"  
P MG-9835

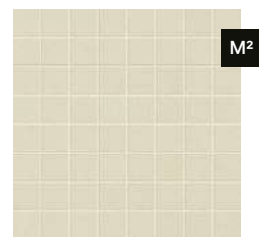

mosaic time 2.0 3,5x3,5  
(all colours)  
**30x30** . 12"x12"  
NR MG-9590



mosaic time 2.0 3,5x3,5\*  
**30x30** . 12"x12"  
ASR MG-9590

✂ NR 10MM

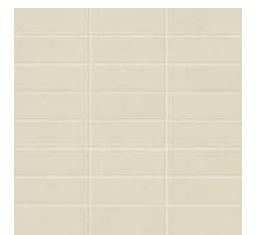

mosaic time 2.0 3,5x10  
(all colours)  
**30x30** . 12"x12"  
NR MP-6270

\*Available in colours Snow, Cream, Beige, Silver, Carbon and Black  
\*Disponible dans les couleurs Snow, Cream, Beige, Silver, Carbon et Black  
\*Erhältlich in den Farben Snow, Cream, Beige, Silver, Carbon und Black  
\*Disponíveis nas cores Snow, Cream, Beige, Silver, Carbon e Black

Mosaic decors are net mounted. All decors may feature shade variations regarding the corresponding floor/wall tile standard tile.  
La décoration Mosaic est sur trame. Toutes les décorations peuvent souffrir variations de tonalité par rapport aux carreaux base.  
Die Mosaic Dekoration ist netzverklebt. Alle Dekorationen können im Vergleich zu den jeweiligen Grundiesen Farbunterschiede aufweisen.  
A decoração Mosaic é sobre rede. Todas as decorações podem sofrer variações de tonalidade em relação aos respectivos mosaicos base.

### special pieces

pièces spéciales . spezialteile . peças especiais



skirting sit-in  
plinthe à gorge  
hohlkehlsoclel  
rodapé curvo  
**16x30** . 6,4"x12"  
NR MP-6230



external corner  
angle externe  
aussenecke  
canto externo  
**3,5x16** . 1,4"x6,4"  
NR MP-6200

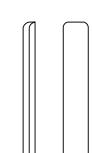

internal corner  
angle interne  
innenecke  
canto interno  
**2,5x16** . 1"x6,4"  
NR MP-6200

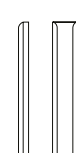

Skirting Sit-In and corners are glazed products.  
La plinthe à gorge et ses angles sont des produits émaillés.  
Der Hohlkehlsoclel und die jeweiligen Ecken sind emailliert.  
O rodapé curvo e os respectivos cantos são produtos esmaltados.

**MARGRES**  
CERAMIC TILES

### special pieces

pièces spéciales . spezialteile . peças especiais

✂ P 11 . 9,5MM . NR,ASR 11 . 10MM

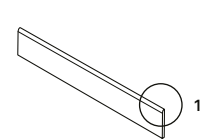

skirting  
plinthe  
sockel  
rodapé boleado

**8x60** . 3,2"x24"

NR MP-6170  
P MP-6180

**8x90** . 3,2"x36"

NR\* MP-6260  
P\* MP-6270

**8x120** . 3,2"x48"

NR\*\* MP-6260  
P\*\* MP-6270

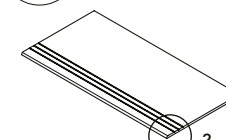
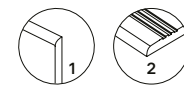

step tread grooved  
nez de marche creusé  
stufenplatte mit rillen  
degrau sulcado

**30x60** . 12"x24"

NR . ASR\* MP-6240  
P MP-6270

**30x90** . 12"x36"

NR\* MP-6430  
P\* MP-6445

**30x120** . 12"x48"

NR\*\* MP-6445  
P\*\* MP-6470

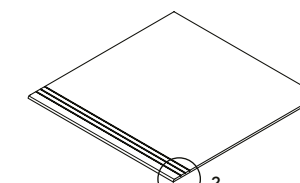

step tread grooved  
nez de marche creusé  
stufenplatte mit rillen  
degrau sulcado

**60x60** . 24"x24"

NR . ASR\* MP-6400  
P MP-6430

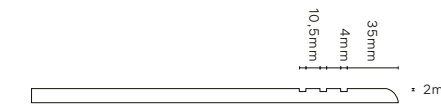

✂ P 11 . 9,5MM . NR,ASR 11 . 10MM

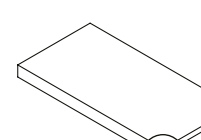

step extra thick  
nez de marche forte épaisseur  
massive stufenplatte  
degrau espessurado

**30x60** . 12"x24"

NR . P MP-6560  
30x120 . 12"x48"

NR . P MP-6650

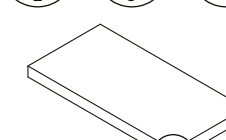

step extra thick corner\*\*\*  
nez de marche forte épaisseur angle\*\*\*  
ecke massive stufenplatte\*\*\*  
degrau espessurado canto\*\*\*

**30x60** . 12"x24"

NR . P MP-6630  
30x120 . 12"x48"

NR . P MP-6690

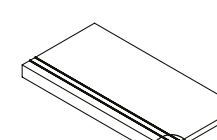

step extra thick inox  
nez de marche forte épaisseur inox  
massive stufenplatte inox  
degrau espessurado inox

**30x60** . 12"x24"

NR . P MP-6580  
30x120 . 12"x48"

NR . P MP-6670

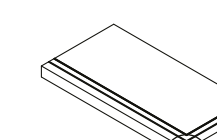

step extra thick corner inox\*\*\*  
nez de marche forte épaisseur angle inox\*\*\*  
ecke massive stufenplatte inox\*\*\*  
degrau espessurado canto inox\*\*\*

**30x60** . 12"x24"

NR . P MP-6650  
30x120 . 12"x48"

NR . P MP-6710



step extra thick corner . nez de marche forte épaisseur angle  
ecke massive stufenplatte . degrau espessurado canto

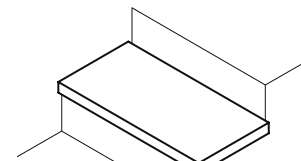

right corner . angle droit  
rechten ecke . canto direito

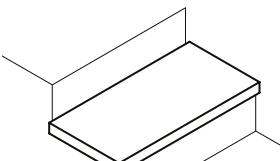

left corner . angle gauche  
links ecke . canto esquerdo

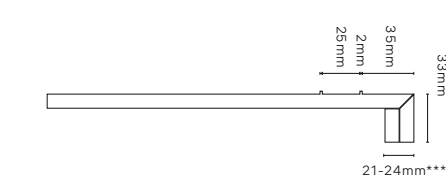

step extra thick corner inox . nez de marche forte épaisseur angle inox  
ecke massive stufenplatte inox . degrau espessurado canto inox

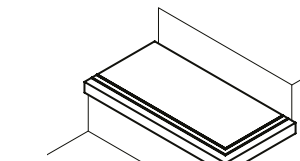

right corner . angle droit  
rechten ecke . canto direito

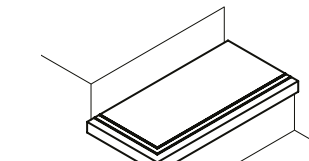

left corner . angle gauche  
links ecke . canto esquerdo

\*Available in colours Snow, Cream, Beige, Silver, Carbon and Black

\*Disponible dans les couleurs Snow, Cream, Beige, Silver, Carbon et Black

\*Erhältlich in den Farben Snow, Cream, Beige, Silver, Carbon und Black

\*Disponíveis nas cores Snow, Cream, Beige, Silver, Carbon e Black

\*\*Available in colours Snow, White, Cream, Silver, Grey and Black

\*\*Disponible dans les couleurs Snow, White, Cream, Silver, Grey et Black

\*\*Erhältlich in den Farben Snow, White, Cream, Silver, Grey und Black

\*\*Disponíveis nas cores Snow, White, Cream, Silver, Grey e Black

\*\*\*Available in right and left corner

\*\*\*Disponível nos cantos direito e esquerdo

\*\*\*Erhältlich in der rechten Ecke und links

\*\*\*Disponível no canto direito e esquerdo

\*\*\*\* Dimension will vary depending on the base tile thickness.

\*\*\*\* La dimension varie selon l'épaisseur du carreau.

\*\*\*\* das Maß variiert je nach Dicke der Fliese.

\*\*\*\* A dimensão varia consoante a espessura do material cerâmico.

index

colour map

collections

concept

edge

endless

evoke

extreme

grove

hybrid

jungle

natural

prestige

pure stone

slabstone

subway

tecnica

time 2.0

tool

underground

linea collections

useful information





218

general catalogue . 2023

low grey EX3 60x60 NR

FULL BODY  
PORCELAIN

# extreme

collection

↓  
DOWNLOAD  
CATALOGUE

↓  
DOWNLOAD  
TECHNICAL  
FEATURES

🌐  
VIEW  
ONLINE

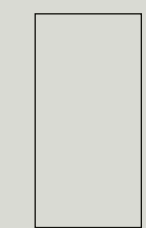

60x120  
NR 9,5mm  
A 9,5mm



45x90  
NR 9mm  
A 9mm

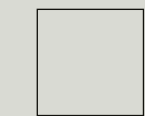

60x60  
NR 8,5mm  
A 8,5mm

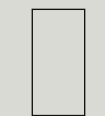

30x60  
NR 8,5mm  
A 8,5mm

rectified products . produits rectifiés . rektifizierte produkte . produtos retificados



low grey  
EX3

extra white  
EX6

UGL V1 R9



pour plus d'informations, consultez  
<https://evaluation.cstb.fr>

**MARGRES**  
CERAMIC TILES

219

general catalogue . 2023

index

colour map

## collections

concept

edge

endless

evoke

extreme

grove

hybrid

jungle

natural

prestige

pure stone

slabstone

subway

tecnica

time 2.0

tool

underground

linea collections

useful information



**extreme**  
collection

**extreme**  
collection

index

colour map

**collections**

concept

edge

endless

evoke

**extreme**

grove

hybrid

jungle

natural

prestige

pure stone

slabstone

subway

tecnica

time 2.0

tool

underground

linea collections

useful information

220

221

general catalogue . 2023

general catalogue . 2023

extra white EX6 60x60 A



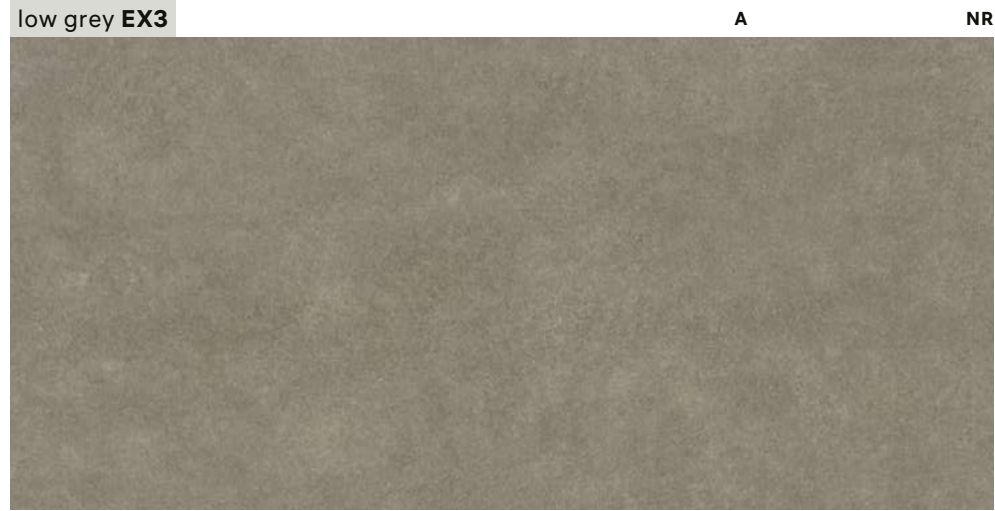

<b>30x60</b> . 12"x24"	8,5mm	<b>NR</b>	R9	MG-2180
	8,5mm	<b>A</b>	-	MG-2450
<b>60x60</b> . 24"x24"	8,5mm	<b>NR</b>	R9	MG-2845
	8,5mm	<b>A</b>	-	MG-3165
<b>45x90</b> . 18"x36"	9mm	<b>NR</b>	R9	MG-3640
	9mm	<b>A</b>	-	MG-3775
<b>60x120</b> . 24"x48"	9,5mm	<b>NR</b>	R9	MG-4735
	9,5mm	<b>A</b>	-	MG-5040



<b>30x60</b> . 12"x24"	8,5mm	<b>NR</b>	R9	MG-2180
	8,5mm	<b>A</b>	-	MG-2450
<b>60x60</b> . 24"x24"	8,5mm	<b>NR</b>	R9	MG-2845
	8,5mm	<b>A</b>	-	MG-3165
<b>45x90</b> . 18"x36"	9mm	<b>NR</b>	R9	MG-3640
	9mm	<b>A</b>	-	MG-3775
<b>60x120</b> . 24"x48"	9,5mm	<b>NR</b>	R9	MG-4735
	9,5mm	<b>A</b>	-	MG-5040

**decors**

décorations . dekorationen . decorações

8,5MM

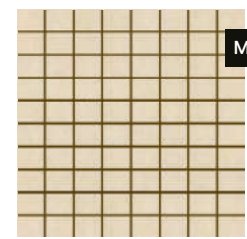

mosaic extreme 3x3,5 extra white  
**30x30** . 12"x12"  
**A** MG-9750

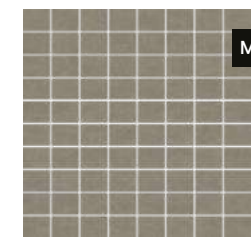

mosaic extreme 3x3,5 low grey  
**30x30** . 12"x12"  
**A** MG-9750

Mosaic decor is net mounted.  
La décoration Mosaic est sur trame.  
Die Mosaic Dekoration ist netzverklebt.  
A decoração Mosaic é sobre rede.

All decors may feature shade variations regarding the corresponding floor/wall tile standard tile.  
Toutes les décorations peuvent souffrir variations de tonalité par rapport aux carreaux base.  
Alle Dekorationen können im Vergleich zu den jeweiligen Grundfliesen Farbunterschiede aufweisen.  
Todas decorações podem sofrer variações de tonalidades em relação aos respetivos mosaicos base.

**special pieces**

pièces spéciales . spezialteile . peças especiais

9,5 - 8,5MM

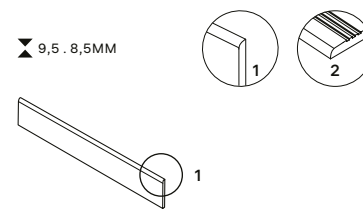

skirting  
plinthe  
sockel  
rodapé boleado

**8x60** . 3,2"x24"

**NR** MP-6170  
**A** MP-6180

**8x120** . 3,2"x48"

**NR** MP-6260  
**A** MP-6270

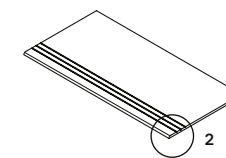

step tread grooved  
nez de marche creusé  
stufenplatte mit rillen  
degrau sulcado

**30x60** . 12"x24"

**NR** MP-6240  
**A** MP-6270

**30x120** . 12"x48"

**NR** MP-6445  
**A** MP-6470

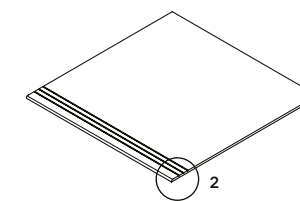

step tread grooved  
nez de marche creusé  
stufenplatte mit rillen  
degrau sulcado

**60x60** . 24"x24"

**NR** MP-6400  
**A** MP-6430







224

general catalogue . 2023

granito beige 33 30x30 AS

**TECHNICAL**  
FULL BODY  
PORCELAIN

**tecnica**  
collection

↓  
DOWNLOAD  
CATALOGUE

↓  
DOWNLOAD  
TECHNICAL  
FEATURES

🌐  
VIEW  
ONLINE

□  
30x30  
N 8,5mm  
AS 8,5mm  
W 8,5mm  
E 12mm

non-rectified product . produit non rectifié . nicht rektifiziert produkt . produto não retificado



granito beige 33   granito cinza 36   platina 41   branco 44   preto 46   granito preto 75

**UGL** **V0** **R11** **R10** **R9** 🧑🧑🧑🧑



pour plus d'informations, consultez  
<https://evaluation.cstb.fr>

**MARGRES**  
CERAMIC TILES

225

general catalogue . 2023

index

colour map

**collections**

concept

edge

endless

evoke

extreme

grove

hybrid

jungle

natural

prestige

pure stone

slabstone

subway

**tecnica**

time 2.0

tool

underground

linea collections

useful information



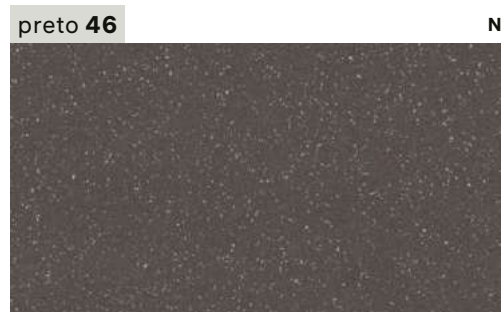
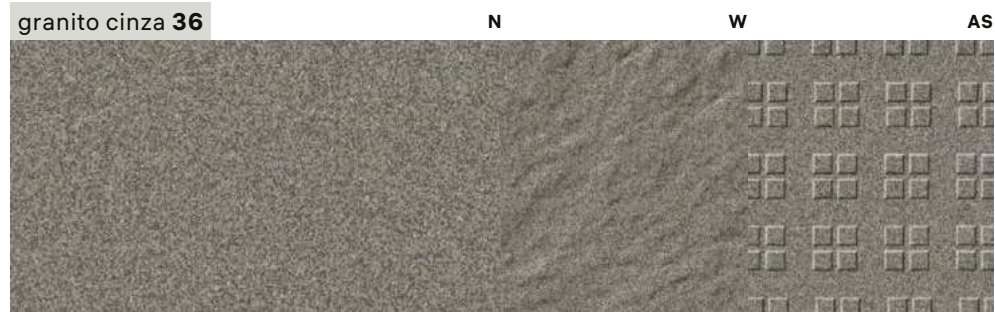
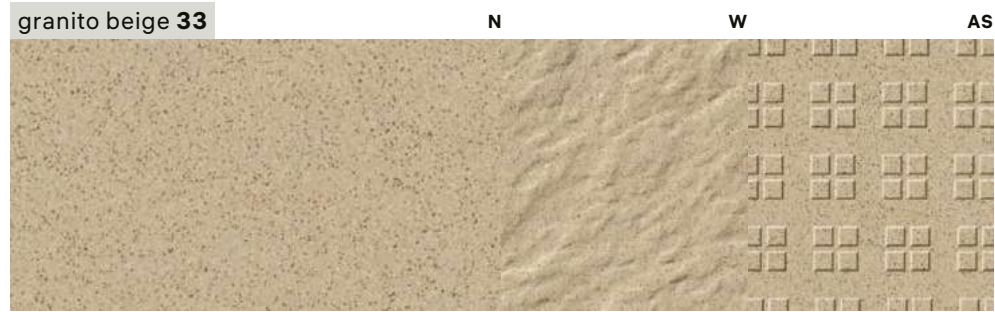

30x30 . 12"x12"	8,5mm	<b>N</b>	R9	MG-1015
	8,5mm	<b>W</b>	R10	MG-1015
	8,5mm	<b>AS</b>	R11	MG-1015

30x30 . 12"x12"	8,5mm	<b>N</b>	R9	MG-1015
	8,5mm	<b>W</b>	R10	MG-1015
	8,5mm	<b>AS</b>	R11	MG-1015

30x30 . 12"x12"	8,5mm	<b>N</b>	R9	MG-1015
	12mm	<b>E</b>	R9	MG-1055
	8,5mm	<b>W</b>	R10	MG-1015
	8,5mm	<b>AS</b>	R11	MG-1015

30x30 . 12"x12"	8,5mm	<b>N</b>	R9	MG-1040
	12mm	<b>E</b>	R9	MG-1080

30x30 . 12"x12"	8,5mm	<b>N</b>	R9	MG-1040
-----------------	-------	----------	----	---------

30x30 . 12"x12"	8,5mm	<b>N</b>	R9	MG-1015
	12mm	<b>E</b>	R9	MG-1055
	8,5mm	<b>W</b>	R10	MG-1015
	8,5mm	<b>AS</b>	R11	MG-1015

**special finishings**

finitions spéciales . speziellen fertigungs . acabamentos especiais

extra thick  
forte épaisseur  
überstärke fliese  
espesurado

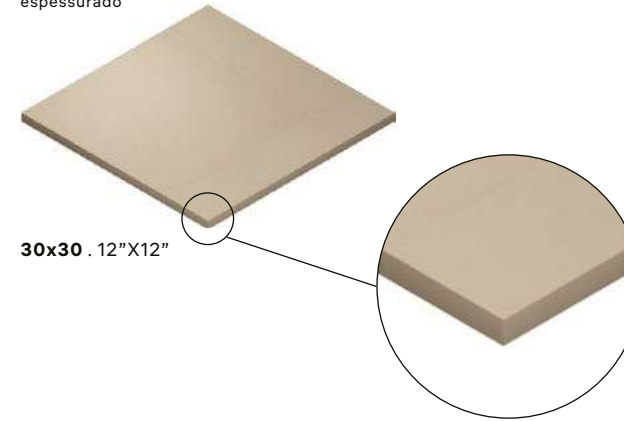

wavy  
ondulé  
wellig  
ondulado

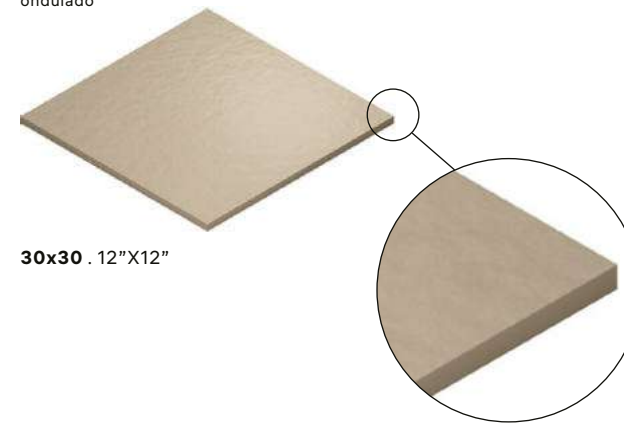

anti-slip  
antidérapant  
rutschfest  
antiderrapante

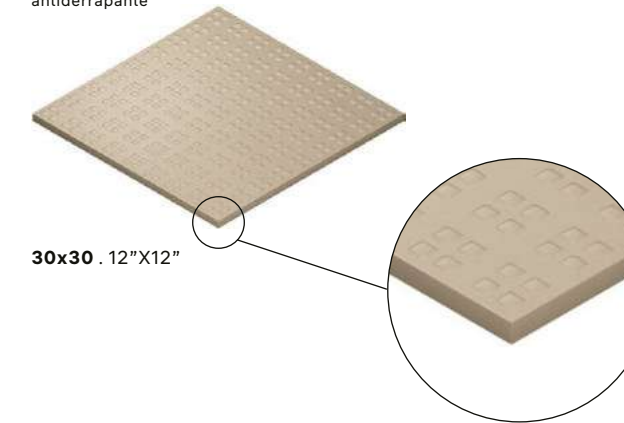

Nor all the presented colours are available in the finishings and indicated formats. Please consult page 226.  
Les couleurs présentées ne sont pas disponibles dans toutes les formats et finitions indiqués. Vous remercions de bien vouloir consulter la page 226.  
Die vorhandenen Ausführungen und Formate sind nicht in allen abgebildeten Farben erhältlich. Bitte sehen sie Seite 226.  
Nem todas as cores apresentadas estão disponíveis nos acabamentos e formatos indicados. Agradecemos a consulta da página 226.

**special pieces**

pièces spéciales . spezialteile . peças especiais

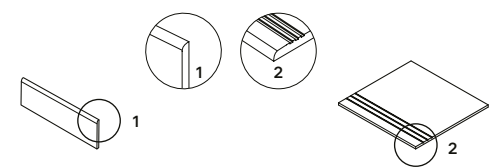

skirting  
plinthe  
sockel  
rodapé boleado  
**9,5x30 . 3,8"x12"**  
**N** MP-6040

step tread grooved  
nez de marche creusé  
stufenplatte mit rillen  
degrau sulcado  
**30x30 . 12"x12"**  
**N** MP-6080



Available in all colours  
Disponible dans toutes les couleurs  
Erhältlich in allen Farben  
Disponível em todas as cores



# LINEA

collections . kollektionen . coleções

<b>cosmos</b>	P. 273
<b>endless</b>	P. 235
<b>magnetic</b>	P. 263
<b>prestige</b>	P. 285
<b>pure stone</b>	P. 255
<b>slabstone</b>	P. 295
<b>subway</b>	P. 305
<b>time 2.0</b>	P. 315
<b>tool</b>	P. 277

229

general catalogue . 2023

index

colour map

collections

**linea collections**

cosmos

endless

magnetic

prestige

pure stone

slabstone

subway

time 2.0

tool

useful information

**MARGRES**  
CERAMIC TILES



## the new surface for avant-garde architecture

LINEA is the new generation of Margres' porcelain tiles which revolutionizes the concept of ceramics, creating new challenges for the use and designing of spaces where other materials were traditionally preferred.

The revolutionary slabs of porcelain tile sheet are produced by means of innovative technology, which combines a pressing force of 15000 tonnes that transforms the purest clays and natural pigments into 3 meters by 1 meter ceramic plates, with 3,5mm, 5,5mm and 6mm thick.

Tiling for swimming pools, ventilated facades, thermal insulation cladding systems and for furniture surfaces. Depending on project specifications and in combination with the construction systems recommended by Margres and approved by the Installation Supervisor.

## la nouvelle surface de l'architecture d'avant-garde

LINEA est la nouvelle génération de grès cérame Margres, qui révolutionne le concept de la céramique, en offrant de nouvelles possibilités d'utilisation et de conception des espaces, là où on utilisait auparavant d'autres matériaux.

Des plaques révolutionnaires de grès cérame sont produites en utilisant une technologie innovatrice, qui transforme, par l'application d'une force de pressage de 15 000 tonnes, des argiles très pures et des pigments naturels en plaques de grès cérame de 3 mètres par 1 mètre, avec 3,5mm, 5,5mm et 6mm d'épaisseur à peine.

Revêtement bassins et piscines, façades ventilées, revêtements thermiques à mur-manteau et surfaces à revêtir dans le secteur de la décoration. En fonction des caractéristiques du projet et en combinaison avec les systèmes de construction indiqués par Margres et approuvés par les maîtres d'oeuvre.

## die neue oberfläche für avantgarde-architektur

LINEA ist die neue Generation des Feinsteinzeug von Margres, die das klassische Keramikkonzept revolutioniert und innovative Möglichkeiten der Raumausnutzung und -gestaltung eröffnet, bei denen bisher andere Materialien bevorzugt wurden.

Bei der Herstellung der bahnbrechenden dünnen Steinzeugplatten wird eine innovative Technologie angewandt, die reinen Ton und natürliche Pigmente mit 15.000 Tonnen Presskraft in nur 3,5mm, 5,5mm und/oder 6mm Stärke Keramikplatten von bis zu 3 Meter x 1 Meter verwandelt.

Becken und Schwimmbecken, Hinterlüftete Fassaden, Thermische Ummantelungen und Verkleidung von Oberflächen in der Möbelbranchen. In Funktion der Projektangaben und in Kombination mit Konstruktionssystemen, die Margres vorgibt und die Arbeitsleitung genehmigt.

## a nova superfície para a arquitetura de vanguarda

LINEA é a nova geração de grés porcelânico Margres que revoluciona o próprio conceito da cerâmica, abrindo novas oportunidades de utilização e conceção do espaço, onde antes eram preferidos outros materiais.

As revolucionárias placas grés lâmina, são produzidas com recurso a uma tecnologia inovadora, que transforma por meio de uma força de prensagem de 15.000 toneladas, argilas puríssimas e pigmentos naturais em placas cerâmicas de 3 metros por 1 metro com 3,5mm, 5,5mm e 6mm de espessura.

Revestimentos de banhos e piscinas, fachadas ventiladas, sistemas de revestimento de isolamento térmico e superfícies de revestimento no sector de decoração. Dependendo das características do projeto e em combinação com sistemas de construção indicadas pela Margres e aprovados pelo supervisor de obra.

### advantages

avantagens . vorteile . vantagens

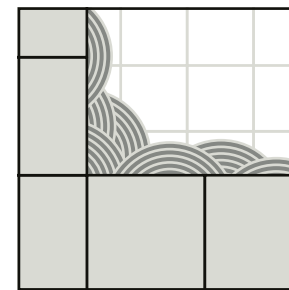

easy to install  
facile à poser  
einfach aufzutragen  
fácil de aplicar

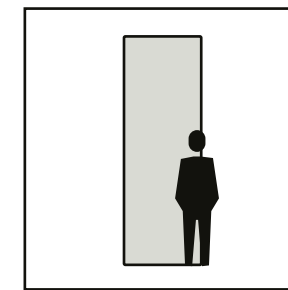

big  
grand  
groß  
grande

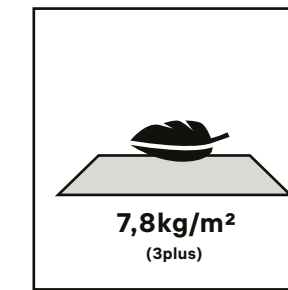

thin and light  
fin et léger  
dünn und leicht  
fino e leve

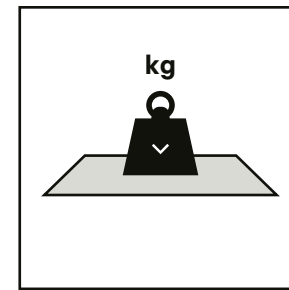

resistent  
résistant  
beständig  
resistente

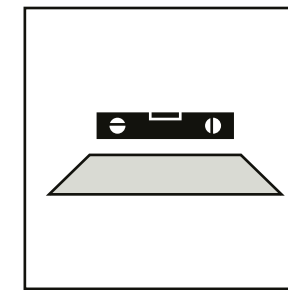

flat  
lisse  
flach  
plano

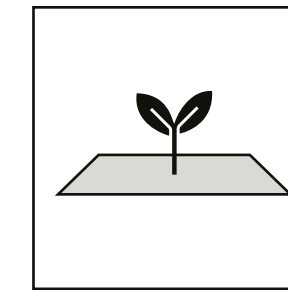

ecofriendly  
écologique  
ökologisch  
ecológico



We reduce the distance between us and zero impact, reducing everything in between. Please see page 326.

Nous réduisons la distance qui nous sépare de l'impact zéro, en réduisant tout ce qui se trouve entre les deux. Veuillez s'il vous plaît consulter la page 326.

Wir verringern den Abstand zwischen uns und der Nullbelastung und reduzieren alles, was dazwischen liegt. Bitte sehen Sie Seite 326.

Diminuímos a distância entre nós e o impacto zero, reduzindo tudo o que está no meio. Por favor, consultar a página 326.

### PROTECT

Antibacterial for Life.

An exclusive line of extremely high performance antimicrobial floor and wall tiles, designed for healthy, safe and protected living spaces. Please see page 324.

Une ligne exclusive de sols et revêtements antibactériens aux performances très élevées, pour un habitat sain, sûr et protégé. Veuillez s'il vous plaît consulter la page 324.

Eine exklusive Linie an hochwertigen Fußböden und antibakteriellen Wandverkleidungen, für ein gesundes, sicheres und geschütztes Leben. Bitte sehen Sie Seite 324.

Uma linha exclusiva de pavimentos e revestimentos antimicrobianos de altíssima performance, projetada para ambientes saudáveis, seguros e protegidos. Por favor, consultar a página 324.







## intended uses

domaines d'emploi . verwendungszwecke . utilizações previstas

## wall installation

pose au mur  
wandverlegung  
aplicação em revestimento

	LINEA 3plus	LINEA 5plus	LINEA 6mm
<p>For <b>new buildings</b> and <b>refurbishing</b> with installation on existing walls. Application dans des <b>nouvelles constructions</b> ou des <b>restructurations</b> avec pose sur des murs préexistants. Anwendungen sowohl in <b>neubauten</b> wie auch <b>renovierungen</b> mit Verlegung auf vorhandenen Wände. Aplicação em <b>novas construções</b> ou intervenções em <b>obras de restauro</b>, com sobreposição do material em revestimentos preexistentes.</p>			
<p> interiors intérieur innenbereiche interiores</p> <p>Any residential and commercial. Toute zone résidentielle et commerciale. Fuer jede Wohn- und Handelsbereich. Qualquer área residencial e comercial.</p>	■	■	■
<p> exteriors extérieur ausenbereiche exteriores</p> <p>On concrete or plaster supports, where corner cuts and large sizes are necessary not larger than 120x120 cm. Sur chape en béton ou enduit où il est nécessaire d'exécuter des découpes angulaires et d'utiliser de grands formats non supérieurs à 120x120 cm. Auf Untergründen aus Beton oder Putz, auf denen Eckschnitte gefertigt und Großformate verwendet werden müssen, nicht größer als 120x120 cm. Em bases de cimento ou reboco, onde é necessária a realização de cortes angulares e/ou aplicar formatos de grandes dimensões não superiores a 120x120cm.</p>	■	■	■

## intended uses

domaines d'emploi . verwendungszwecke . utilizações previstas

## floor installation

pose au sol  
bodenverlegung  
aplicação em pavimento

	LINEA 3plus	LINEA 5plus	LINEA 6mm
<p>For <b>new buildings</b> and <b>refurbishing</b> with installation on existing floors. Application dans des <b>nouvelles constructions</b> ou des <b>restructurations</b> avec pose sur des sols préexistants. Für <b>neubauten</b> und <b>renovierungen</b> mit Verlegung auf vorhandenen Böden. Aplicação em <b>novas construções</b> ou intervenções em <b>obras de restauro</b>, com sobreposição do material em pavimentos preexistentes.</p>			
<p> interiors intérieur innenbereiche interiores</p> <p><b>Residential</b> (kitchens, bathrooms, living rooms, common apartment block areas and any other residential environment) with the exception of areas subject to heavy loads (e.g. trolleys with hard wheels). <b>Résidentiel</b> (cuisines, salles de bains, salles de séjour, zones de copropriété collectives, et tout autre espace à usage résidentiel). Sauf les zones soumises au passage de charges lourdes concentrées (ex.: chariots à roues dures). <b>Wohnbereiche</b> (Küchen, Badezimmer, Wohnzimmer, Gemeinschaftsflächen in Mehrfamilienhäusern und alle sonstigen Wohnbereiche). Ausgenommen Bereiche mit Durchfahrtsverkehr von konzentrierten Schwerlasten (z.B. Wagen mit Hartgummirädern). <b>Utilização residencial</b> (cozinhas, casas de banho, salas de estar, áreas comuns de condomínios e em qualquer outro ambiente de uso residencial), excluindo zonas sujeitas a passagem de cargas pesadas concentradas (por exemplo, carrinhos com rodas rígidas).</p>	■	■	■
<p><b>Light commercial</b> (offices, offices open to the general public, waiting rooms, shops, bathrooms, restaurant dining rooms, car showrooms, bars, cinemas, surgeries/clinics) with the exception of areas subject to heavy loads (e.g. trolleys with hard wheels). <b>Traffic moderé</b> (bureaux, bureaux ouverts au public, salles d'attente, magasins, salles de bains, salles de restaurants, salons automobiles, bars, cinémas, dispensaires/cliniques). Sauf les zones soumises au passage de charges lourdes concentrées (ex.: chariots à roues dures). <b>Leichte gewerbliche anwendungen</b> (Büroräume, öffentliche Büros, Wartezimmer, Geschäfte, Toiletten, Gaststätten, Autohäuser, Cafés, Kinos, Praxen/Kliniken). Ausgenommen Bereiche mit Durchfahrtsverkehr von konzentrierten Schwerlasten (z.B. Wagen mit Hartgummirädern). <b>Utilização comercial ligeira</b> (escritórios, escritórios abertos ao público, salas de espera, lojas, casas de banho, salas de restaurantes, stands de automóveis, bares, cinemas, centros de saúde/clinicas), excluindo zonas sujeitas a passagem de cargas pesadas concentradas (por exemplo, carrinhos com rodas rígidas).</p>	■	■ except polished sauf poli Außer poliert exceto polido	■
<p><b>Heavy duty commercial</b> (public areas of shopping centres, hotel halls, canteens, fast food restaurants, clubs, hospitals) with the exception of areas subject to heavy loads (e.g. trolleys with hard wheels). <b>Commercial intensif</b> (zones communes de centres commerciaux, halls d'hôtels, cantines, fast-foods, discothèques, hôpitaux). Sauf les zones soumises au passage de charges lourdes concentrées (ex.: chariots à roues dures). <b>Intensive gewerbliche anwendungen</b> (Gemeinschaftsbereiche in Einkaufszentren, Hotelhallen, Kantinen, Fastfood-Restaurants, Diskotheken, Krankenhäuser). Ausgenommen Bereiche mit Durchfahrtsverkehr von konzentrierten Schwerlasten (z.B. Wagen mit Hartgummirädern). <b>Utilização comercial intensiva</b> (áreas comuns de centros comerciais, lobbies de hotéis, cantinas, restaurantes de fastfood, discotecas, hospitais), excluindo zonas sujeitas a passagem de cargas pesadas concentradas (por exemplo, carrinhos com rodas rígidas).</p>		■ except polished sauf poli Außer poliert exceto polido	■

Installation must be performed in compliance with the standards published on the Margres Technical Manual.  
La pose doit être effectuée selon les normes publiées dans le Manuel Technique Margres.  
Die Verlegung muss nach den Vorschriften im Technischen Handbuch von Margres erfolgen.  
A aplicação deve ser realizada em conformidade com as normas publicadas no Manual Técnico Margres.

## special uses

utilisations spéciales . spezielle verwendungszwecke . aplicações especiais

Tiling for swimming pools, ventilated facades, thermal insulation cladding systems and for furniture surfaces.  
Depending on project specifications and in combination with the construction systems recommended by Margres and approved by the Installation Supervisor.

Revêtement bassins et piscines, façades ventilées, revêtements thermiques à mur-manteau et surfaces à revêtir dans le secteur de la décoration.  
En fonction des caractéristiques du projet et en combinaison avec les systèmes de construction indiqués par Margres et approuvés par les maîtres d'oeuvre.

Becken und Schwimmbecken, Hinterlüftete Fassaden, Thermische Ummantelungen und Verkleidung von Oberflächen in der Möbelbranchen.  
In Funktion der Projektangaben und in Kombination mit Konstruktionssystemen, die Margres vorgibt und die Arbeitsleitung genehmigt.

Revestimentos de banhos e piscinas, fachadas ventiladas, sistemas de revestimento de isolamento térmico e superfícies de revestimento no sector de decoração.  
Dependendo das características do projeto e em combinação com sistemas de construção indicadas pela Margres e aprovados pelo supervisor de obra.





general catalogue . 2023

chain breccia capraia LED2 100x300 P . slabstone grey LSL5 100x100 NR

LAMINATED  
PORCELAIN  
STONEWARE

# linea endless

collection  
P. 027

↓  
DOWNLOAD  
CATALOGUE

↓  
DOWNLOAD  
TECHNICAL  
FEATURES

🌐  
VIEW  
ONLINE



100x300  
SM . P 5,5mm

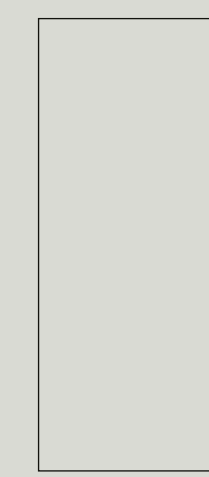

100x250  
SM . P 5,5mm

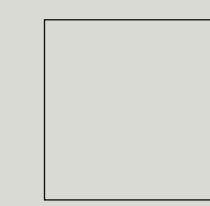

100x100  
SM . P 5,5mm



50x100  
SM . P 5,5mm

rectified products . produits rectifiés . rektifizierete produkte . produtos retificados

235

general catalogue . 2023



calacatta  
gold  
LED1

breccia  
capraia  
LED2

travertino  
LED3

port black  
LED4

amazonite  
LED5

UGL V2 R10

**PR( )TECT®**  
Antibacterial for Life.

index

colour map

collections

## linea collections

cosmos

endless

magnetic

prestige

pure stone

slabstone

subway

time 2.0

tool

useful information





236

general catalogue . 2023



237

general catalogue . 2023

calacatta gold LED1 100x300 SM . 100x100 SM . port black LED4 P

index

colour map

collections

linea collections

cosmos

endless

magnetic

prestige

pure stone

slabstone

subway

time 2.0

tool

useful information



linea endless  
collection

linea endless  
collection

index

colour map

collections

linea collections

cosmos

endless

magnetic

prestige

pure stone

slabstone

subway

time 2.0

tool

useful information

238

general catalogue . 2023

239

general catalogue . 2023

calacatta gold LED1 100x300 P . 100x100 P





240

general catalogue . 2023



241

general catalogue . 2023

breccia capraia LED2 100x300 SM . 100x100 SM

index

colour map

collections

linea collections

cosmos

endless

magnetic

prestige

pure stone

slabstone

subway

time 2.0

tool

useful information





242

general catalogue . 2023



243

general catalogue . 2023

index

colour map

collections

linea collections

cosmos

endless

magnetic

prestige

pure stone

slabstone

subway

time 2.0

tool

useful information



linea endless

collection



linea endless

collection



index

colour map

collections

linea collections

cosmos

endless

magnetic

prestige

pure stone

slabstone

subway

time 2.0

tool

useful information





246

general catalogue - 2023

247

general catalogue - 2023



**linea endless**  
collection



248

general catalogue . 2023

**MARGRES**  
CERAMIC TILES

**linea endless**  
collection



249

general catalogue . 2023

amazonite LED5 100x300 P . 100x100 P

index

colour map

collections

**linea collections**

cosmos

endless

magnetic

prestige

pure stone

slabstone

subway

time 2.0

tool

useful information



## linea endless

collection

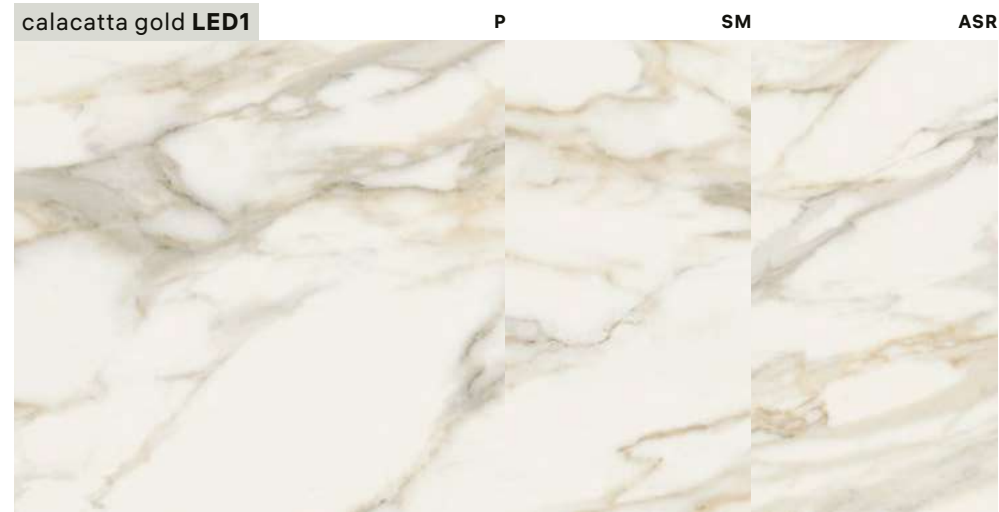

### LINEA

50x100 . 19,6"x39,4"	5,5mm	<b>SM</b>	-	M3-1930
	5,5mm	<b>P</b>	-	M3-2330
100x100 . 39,4"x39,4"	5,5mm	<b>SM</b>	-	M3-2730
	5,5mm	<b>P</b>	-	M3-3130
100x250 . 39,4"x98,4"	5,5mm	<b>SM</b>	-	M3-3530
	5,5mm	<b>P</b>	-	M3-3830
100x300 . 39,4"x118"	5,5mm	<b>SM</b>	-	M3-4230
	5,5mm	<b>P</b>	-	M3-4630

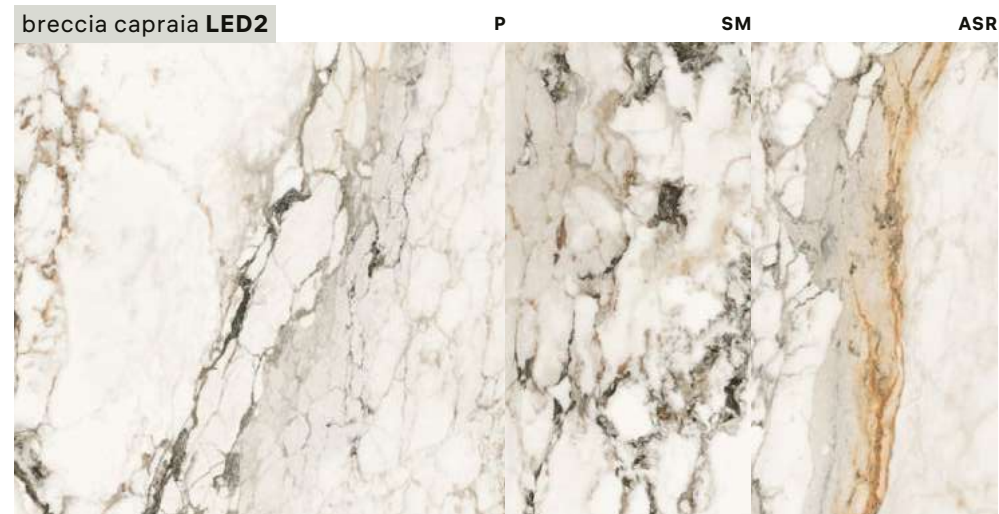

### LINEA

50x100 . 19,6"x39,4"	5,5mm	<b>SM</b>	-	M3-1930
	5,5mm	<b>P</b>	-	M3-2330
100x100 . 39,4"x39,4"	5,5mm	<b>SM</b>	-	M3-2730
	5,5mm	<b>P</b>	-	M3-3130
100x250 . 39,4"x98,4"	5,5mm	<b>SM</b>	-	M3-3530
	5,5mm	<b>P</b>	-	M3-3830
100x300 . 39,4"x118"	5,5mm	<b>SM</b>	-	M3-4230
	5,5mm	<b>P</b>	-	M3-4630

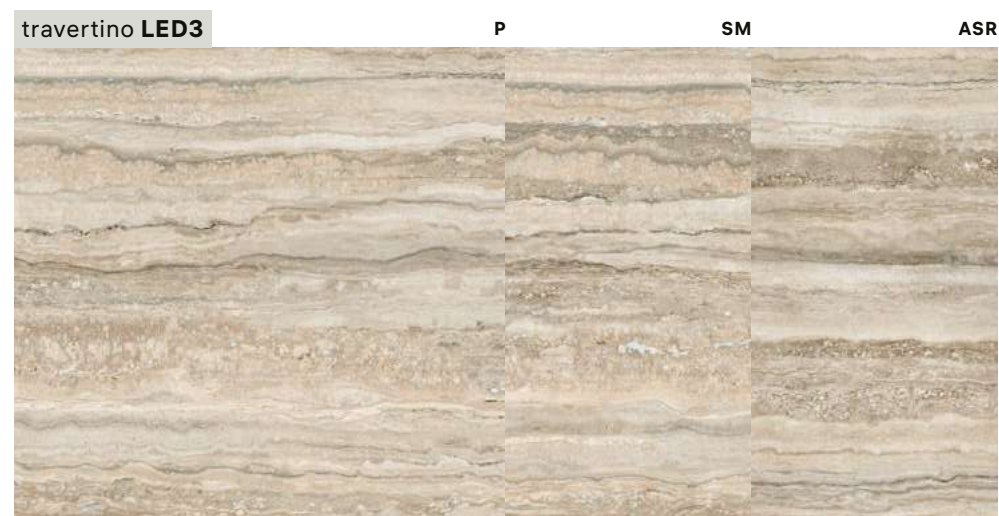

### LINEA

50x100 . 19,6"x39,4"	5,5mm	<b>SM</b>	-	M3-1930
	5,5mm	<b>P</b>	-	M3-2330
100x100 . 39,4"x39,4"	5,5mm	<b>SM</b>	-	M3-2730
	5,5mm	<b>P</b>	-	M3-3130
100x250 . 39,4"x98,4"	5,5mm	<b>SM</b>	-	M3-3530
	5,5mm	<b>P</b>	-	M3-3830
100x300 . 39,4"x118"	5,5mm	<b>SM</b>	-	M3-4230
	5,5mm	<b>P</b>	-	M3-4630

## linea endless

collection

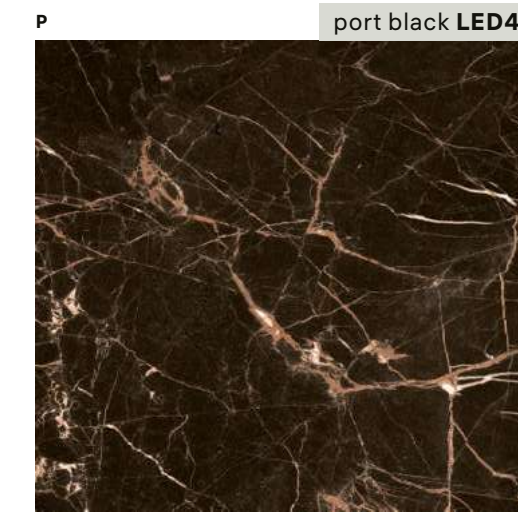

### LINEA

50x100 . 19,6"x39,4"	5,5mm	<b>P</b>	-	M3-2330
	5,5mm	<b>P</b>	-	M3-3130
100x250 . 39,4"x98,4"	5,5mm	<b>P</b>	-	M3-3830
	5,5mm	<b>P</b>	-	M3-4630

### LINEA

50x100 . 19,6"x39,4"	5,5mm	<b>P</b>	-	M3-2330
	5,5mm	<b>P</b>	-	M3-3130
100x250 . 39,4"x98,4"	5,5mm	<b>P</b>	-	M3-3830
	5,5mm	<b>P</b>	-	M3-4630



### amazonite LED5

index

colour map

collections

linea collections

cosmos

endless

magnetic

prestige

pure stone

slabstone

subway

time 2.0

tool

useful information

Products with a polished finish are more sensitive to abrasion and stains, what requires special conditions. Please see page 348 in chapter 09.  
 Les produits à finition polie sont plus sensibles à l'abrasion et aux taches, ce qui requiert des conditions particulières. Veuillez-vous consulter la page 348 du chapitre 09.  
 Produkte mit einer polierten Oberfläche sind empfindlicher gegen Abrieb und Fleckenbildung, was besondere Bedingungen erfordert. Bitte beachten Sie Seite 348 in Kapitel 09.  
 Os produtos com acabamento polido são mais sensíveis à abrasão e às manchas, o que requer condições especiais. Por favor consulte a página 348 no capítulo 09.

**MARGRES**  
CERAMIC TILES

**PROTECT**  
Antibacterial for Life.



## linea endless

collection

### chain breccia capraia LED2



A B C D E

### LINEA

100x300 . 39,4"x118" 5,5mm P - M3-4930

### chain amazonite LED5



A B C D E

### LINEA

100x300 . 39,4"x118" 5,5mm P - M3-4930

Can only be purchased as complete composition.

Cette composition ne peut être vendue séparément, mais en un ensemble unique.

Nur in voller Zusammensetzung erhältlich.

Só pode ser adquirido como conjunto completo.

The picture is purely illustrative. The graphic design of **chain** may result in discontinuities in the veining between panels, as with the natural material. Discontinuities of up to 1,5 cm are not defects, but are characteristic of the product.

L'image n'est donnée qu'à titre indicatif. Le graphisme de **chain** peut présenter une discontinuité du veinage dans le passage entre les dalles, tout comme le matériau naturel. Toute différence jusqu'à 1,5 cm doit donc être considérée comme une caractéristique du produit.

Die Abbildung ist rein illustrativ. Die Grafik **chain** kann wie beim natürlichen Material Maserungs-Diskontinuitäten beim Übergang zwischen den Platten aufweisen. Eventuelle Unterschiede bis zu 1,5 cm gelten daher als produkttypisch.

A imagem é puramente indicativa. O desenho gráfico do **chain** pode mostrar uma descontinuidade do veio na transição entre painéis cerâmicos, tal como no material natural. Quaisquer diferenças até 1,5 cm devem ser consideradas como uma característica do produto.

**MARGRES**  
CERAMIC TILES

## linea endless

collection



index

colour map

collections

linea collections

cosmos

endless

magnetic

prestige

pure stone

slabstone

subway

time 2.0

tool

useful information

port black LED4 100x100 P





beige LPS2 100x300 NR . grey LPS4 100x300 NR . 100x100 NR

LAMINATED  
PORCELAIN  
STONEWARE

# linea pure stone

collection —  
P. 039

↓  
DOWNLOAD  
CATALOGUE

↓  
DOWNLOAD  
TECHNICAL  
FEATURES

🌐  
VIEW  
ONLINE

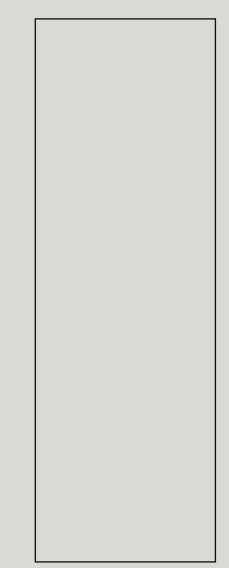

100x300  
NR 6mm

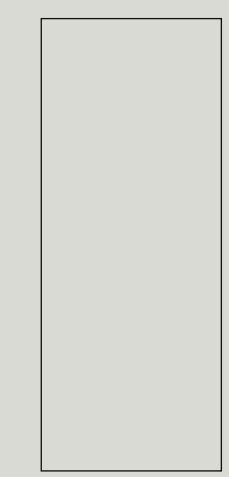

100x250  
NR 6mm

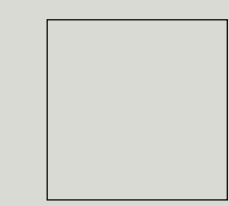

100x100  
NR 6mm



50x100  
NR 6mm

rectified products . produits rectifiés . rektifizierete produkte . produtos retificados



white  
LPS1

beige  
LPS2

light grey  
LPS3

grey  
LPS4

forge white  
LPS1F

forge light grey  
LPS3F

UGL V2 R10 R9 🧑🧑🧑

**PR( )TECT®**

Antibacterial for Life.

**MARGRES**  
CERAMIC TILES

index —

colour map —

collections —

## linea collections

cosmos

endless

magnetic

prestige

pure stone

slabstone

subway

time 2.0

tool

## useful information



linea pure stone  
collection

linea pure stone  
collection

index

colour map

collections

linea collections

cosmos

endless

magnetic

prestige

pure stone

slabstone

subway

time 2.0

tool

useful information

256

general catalogue . 2023

257

general catalogue . 2023

white LPS1 100x300 NR . 100x100 NR



**linea pure stone**  
collection



258

general catalogue . 2023

**MARGRES**  
CERAMIC TILES

**linea pure stone**  
collection



259

general catalogue . 2023

light grey LPS3 100x300 NR . 100x100 NR

index

colour map

collections

**linea collections**

cosmos

endless

magnetic

prestige

**pure stone**

slabstone

subway

time 2.0

tool

useful information



# linea pure stone

collection

white LPS1



NR

## LINEA

50x100 . 19,6"x39,4"	6mm	NR	R9	M3-5230
100x100 . 39,4"x39,4"	6mm	NR	R9	M3-6230
100x250 . 39,4"x98,4"	6mm	NR	R9	M3-7300
100x300 . 39,4"x118"	6mm	NR	R9	M3-7730

beige LPS2



NR

## LINEA

50x100 . 19,6"x39,4"	6mm	NR	R9	M3-5230
100x100 . 39,4"x39,4"	6mm	NR	R9	M3-6230
100x250 . 39,4"x98,4"	6mm	NR	R9	M3-7300
100x300 . 39,4"x118"	6mm	NR	R9	M3-7730

light grey LPS3



NR

## LINEA

50x100 . 19,6"x39,4"	6mm	NR	R9	M3-5230
100x100 . 39,4"x39,4"	6mm	NR	R9	M3-6230
100x250 . 39,4"x98,4"	6mm	NR	R9	M3-7300
100x300 . 39,4"x118"	6mm	NR	R9	M3-7730

# linea pure stone

collection

grey LPS4



NR

## LINEA

50x100 . 19,6"x39,4"	6mm	NR	R9	M3-5230
100x100 . 39,4"x39,4"	6mm	NR	R9	M3-6230
100x250 . 39,4"x98,4"	6mm	NR	R9	M3-7300
100x300 . 39,4"x118"	6mm	NR	R9	M3-7730

NR

forge white LPS1F



## LINEA

50x100 . 19,6"x39,4"	6mm	NR	R10	M3-5230
100x100 . 39,4"x39,4"	6mm	NR	R10	M3-6230
100x250 . 39,4"x98,4"	6mm	NR	R10	M3-7300
100x300 . 39,4"x118"	6mm	NR	R10	M3-7730

NR

forge light grey LPS3F



## LINEA

50x100 . 19,6"x39,4"	6mm	NR	R10	M3-5230
100x100 . 39,4"x39,4"	6mm	NR	R10	M3-6230
100x250 . 39,4"x98,4"	6mm	NR	R10	M3-7300
100x300 . 39,4"x118"	6mm	NR	R10	M3-7730





262

general catalogue . 2023

cement anthracite LMC2 100x100 NR

LAMINATED  
PORCELAIN  
STONEWARE

# linea magnetic

collection

↓  
DOWNLOAD  
CATALOGUE

↓  
DOWNLOAD  
TECHNICAL  
FEATURES

🌐  
VIEW  
ONLINE



100x300  
NR 6mm

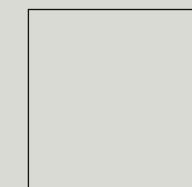

100x100  
NR 6mm

rectified products . produits rectifiés . rektifizierete produkte . produtos retificados

263

general catalogue . 2023



cement grey  
LMC1

cement anthracite  
LMC2

stone grey  
LMS3

stone anthracite  
LMS4

UGL V2 R10 R9

**PR( )TECT®**

Antibacterial for Life.

**MARGRES**  
CERAMIC TILES

index

colour map

collections

linea collections

cosmos

endless

magnetic

prestige

pure stone

slabstone

subway

time 2.0

tool

useful information





264

general catalogue - 2023

stone grey LMS3 100x300 NR . stone anthracite LMS4 100x100 NR



265

general catalogue - 2023

stone grey LMS3 100x300 NR . 100x100 NR

index

colour map

collections

linea collections

cosmos

endless

magnetic

prestige

pure stone

slabstone

subway

time 2.0

tool

useful information



linea magnetic  
— collection

linea magnetic  
collection —

index

colour map

collections

linea collections

cosmos

endless

magnetic

prestige

pure stone

slabstone

subway

time 2.0

tool

useful information



266

267

general catalogue . 2023

general catalogue . 2023





268

general catalogue . 2023



269

general catalogue . 2023

cement grey LMC1 100x300 NR . 100x100 NR

index

colour map

collections

linea collections

cosmos

endless

magnetic

prestige

pure stone

slabstone

subway

time 2.0

tool

useful information



**linea magnetic**  
collection

cement grey **LMC1** NR



LINEA					
<b>100x100</b>	. 39,4"x39,4"	6mm	<b>NR</b>	R9	M3-6230
<b>100x300</b>	. 39,4"x118"	6mm	<b>NR</b>	R9	M3-7730

cement anthracite **LMC2** NR



LINEA					
<b>100x100</b>	. 39,4"x39,4"	6mm	<b>NR</b>	R9	M3-6230
<b>100x300</b>	. 39,4"x118"	6mm	<b>NR</b>	R9	M3-7730

**linea magnetic**  
collection

NR stone grey **LMS3**



LINEA					
<b>100x100</b>	. 39,4"x39,4"	6mm	<b>NR</b>	R10	M3-6230
<b>100x300</b>	. 39,4"x118"	6mm	<b>NR</b>	R10	M3-7730

NR stone anthracite **LMS4**



LINEA					
<b>100x100</b>	. 39,4"x39,4"	6mm	<b>NR</b>	R10	M3-6230
<b>100x300</b>	. 39,4"x118"	6mm	<b>NR</b>	R10	M3-7730

index

colour map

collections

**linea collections**

cosmos

endless

**magnetic**

prestige

pure stone

slabstone

subway

time 2.0

tool

useful information





272

general catalogue . 2023

iron LCM2 100x300 NR . 100x100 NR

LAMINATED  
PORCELAIN  
STONEWARE

# linea cosmos

collection

↓  
DOWNLOAD  
CATALOGUE  
LINEA

↓  
DOWNLOAD  
TECHNICAL  
FEATURES

🌐  
VIEW  
ONLINE

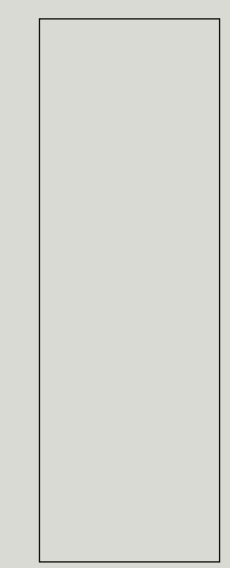

100x300  
NR 3,5mm

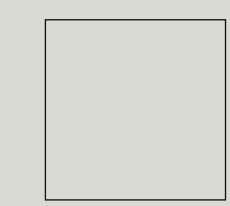

100x100  
NR 3,5mm

rectified products . produits rectifiés . rektifizierete produkte . produtos retificados



corten  
LCM1

iron  
LCM2

UGL V2 R10 🧑🧑🧑

**PROTECT**  
Antibacterial for Life.

**MARGRES**  
CERAMIC TILES

index

colour map

collections

## linea collections

cosmos

endless

magnetic

prestige

pure stone

slabstone

subway

time 2.0

tool

## useful information

273

general catalogue . 2023



linea cosmos  
collection



274

general catalogue . 2023

corten LCM1 100x300 NR . 100x100 NR

linea cosmos  
collection

LINEA

100x100 . 39,4"x39,4"	3,5mm	NR	R10	M3-1230
100x300 . 39,4"x118"	3,5mm	NR	R10	M3-1530

LINEA

100x100 . 39,4"x39,4"	3,5mm	NR	R10	M3-1230
100x300 . 39,4"x118"	3,5mm	NR	R10	M3-1530

NR

corten LCM1



NR

iron LCM2



275

general catalogue . 2023

index

colour map

collections

linea collections

cosmos

endless

magnetic

prestige

pure stone

slabstone

subway

time 2.0

tool

useful information

PR( )TECT<sup>®</sup>  
Antibacterial for Life.





276

general catalogue . 2023

tortora LTL3 120x260 NR . 120x120 NR

LAMINATED  
PORCELAIN  
STONEWARE

# linea tool

collection —  
P. 145

↓  
DOWNLOAD  
CATALOGUE

↓  
DOWNLOAD  
TECHNICAL  
FEATURES

🌐  
VIEW  
ONLINE

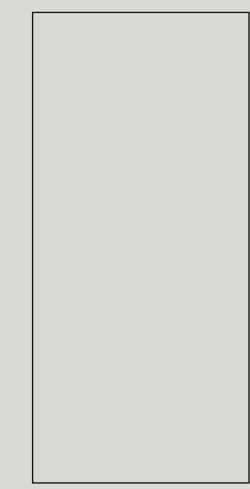

120x260  
NR 6mm

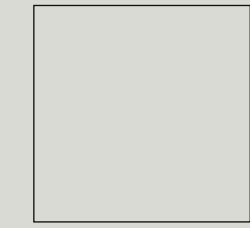

120x120  
NR 6mm

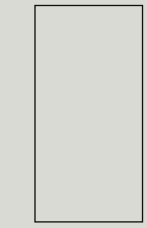

60x120  
NR 6mm

rectified products . produits rectifiés . rektifizierete produkte . produtos retificados



white  
LTL1

light grey  
LTL2

tortora  
LTL3

grey  
LTL4

UGL V3 R9

**PR( )TECT®**  
Antibacterial for Life.

**MARGRES**  
CERAMIC TILES

277

general catalogue . 2023

[index](#)

[colour map](#)

[collections](#)

## linea collections

cosmos

endless

magnetic

prestige

pure stone

slabstone

subway

time 2.0

tool

[useful information](#)





linea tool  
collection

linea tool  
collection

278

general catalogue, 2023

279

general catalogue, 2023

grey LTL4 120x120 NR

index

colour map

collections

linea collections

cosmos

endless

magnetic

prestige

pure stone

slabstone

subway

time 2.0

**tool**

useful information





280

general catalogue . 2023



281

general catalogue . 2023

light grey LTL2 120x260 NR . 120x120 NR . white LTL1 NR

index

colour map

collections

linea collections

cosmos

endless

magnetic

prestige

pure stone

slabstone

subway

time 2.0

tool

useful information



## linea tool

collection

white LTL1



NR

### LINEA

60x120 . 24"x48"	6mm	NR	R9	M3-5730
120x120 . 48"x48"	6mm	NR	R9	M3-6730
120x260 . 48"x102"	6mm	NR	R9	M3-8230

tortora LTL3



NR

### LINEA

60x120 . 24"x48"	6mm	NR	R9	M3-5730
120x120 . 48"x48"	6mm	NR	R9	M3-6730
120x260 . 48"x102"	6mm	NR	R9	M3-8230

### LINEA

60x120 . 24"x48"	6mm	NR	R9	M3-5730
120x120 . 48"x48"	6mm	NR	R9	M3-6730
120x260 . 48"x102"	6mm	NR	R9	M3-8230

NR



light grey LTL2

NR



grey LTL4

282

general catalogue . 2023

283

general catalogue . 2023

**MARGRES**  
CERAMIC TILES

**PROTECT**  
Antibacterial for Life.

index

colour map

collections

linea collections

cosmos

endless

magnetic

prestige

pure stone

slabstone

subway

time 2.0

tool

useful information





284

general catalogue . 2023

calacatta LPT1 100x300 P . 100x100 P

LAMINATED  
PORCELAIN  
STONEWARE

# linea prestige

collection —  
P. 093

↓  
DOWNLOAD  
CATALOGUE

↓  
DOWNLOAD  
TECHNICAL  
FEATURES

🌐  
VIEW  
ONLINE



100x300  
NR . P 5,5mm

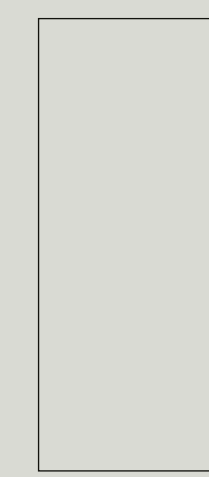

100x250  
NR . P 5,5mm

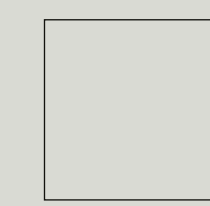

100x100  
NR . P . ASR 5,5mm



50x100  
NR . P 5,5mm

rectified products . produits rectifiés . rektifizierete produkte . produtos retificados

285

general catalogue . 2023



calacatta  
LPT1

corinthian  
beige  
LPT2

travertino  
grey  
LPT3

fior di bosco  
tortora  
LPT4

emperador  
black  
LPT5

**UGL** **V2** **R10**   
NR . ASR P

**PR( )TECT®**  
Antibacterial for Life.

**MARGRES**  
CERAMIC TILES

index —

colour map —

collections —

## linea collections

cosmos

endless

magnetic

prestige

pure stone

slabstone

subway

time 2.0

tool

## useful information





travertino grey LPT3 100x300 NR . 100x100 NR



calacatta LPT1 100x300 P . 100x100 ASR

index

colour map

collections

linea collections

cosmos

endless

magnetic

prestige

pure stone

slabstone

subway

time 2.0

tool

useful information





288

general catalogue, 2023

289

general catalogue, 2023





290  
|  
general catalogue, 2023

corinthian beige LPT2 100x300 NR . 100x100 NR . emperador black LPT5 100x300 P



291  
|  
general catalogue, 2023

emperador black LPT5 100x300 P . 100x100 P

index

colour map

collections

linea collections

cosmos

endless

magnetic

prestige

pure stone

slabstone

subway

time 2.0

tool

useful information



**linea prestige**  
collection

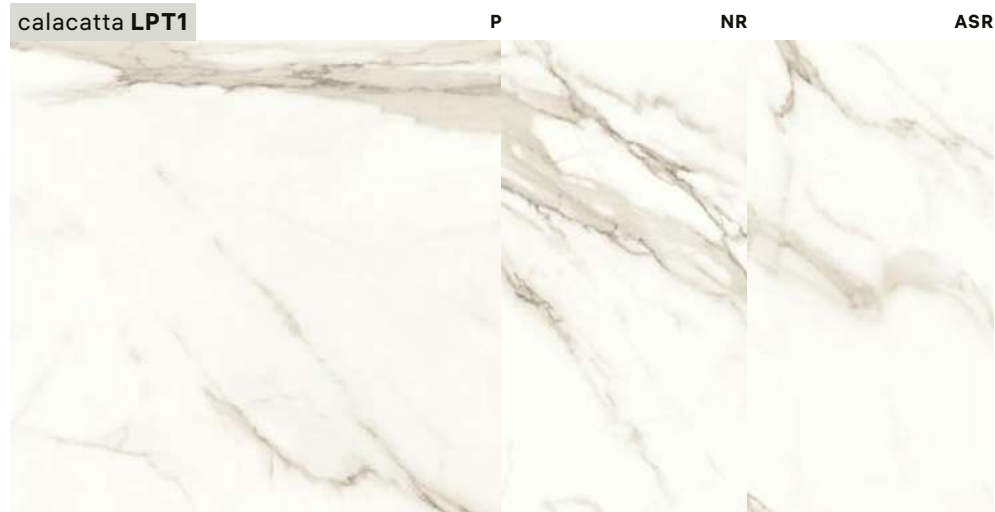

LINEA					
50x100 . 19,6"x39,4"	5,5mm	NR	-	M3-1930	
	5,5mm	P	-	M3-2330	
100x100 . 39,4"x39,4"	5,5mm	ASR	R10	M3-2730	
	5,5mm	NR	-	M3-2730	
100x250 . 39,4"x98,4"	5,5mm	NR	-	M3-3530	
	5,5mm	P	-	M3-3830	
100x300 . 39,4"x118"	5,5mm	NR	-	M3-4230	
	5,5mm	P	-	M3-4630	

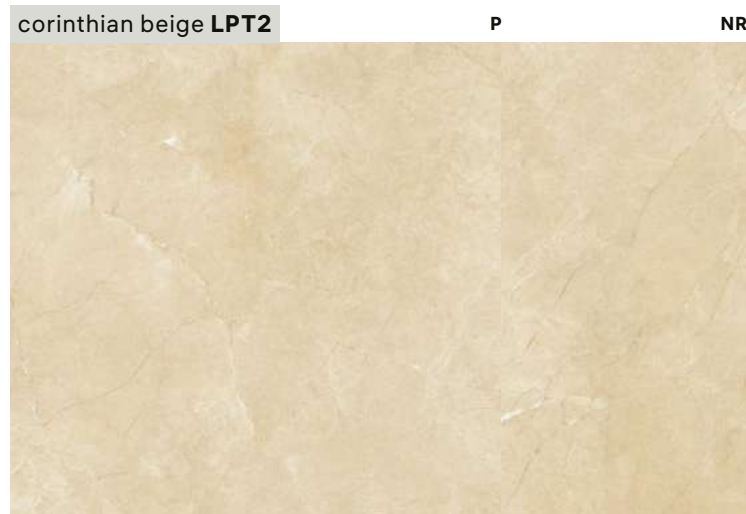

LINEA					
50x100 . 19,6"x39,4"	5,5mm	NR	-	M3-1930	
	5,5mm	P	-	M3-2330	
100x100 . 39,4"x39,4"	5,5mm	NR	-	M3-2730	
	5,5mm	P	-	M3-3130	
100x250 . 39,4"x98,4"	5,5mm	NR	-	M3-3530	
	5,5mm	P	-	M3-3830	
100x300 . 39,4"x118"	5,5mm	NR	-	M3-4230	
	5,5mm	P	-	M3-4630	



LINEA					
50x100 . 19,6"x39,4"	5,5mm	NR	-	M3-1930	
	5,5mm	P	-	M3-2330	
100x100 . 39,4"x39,4"	5,5mm	NR	-	M3-2730	
	5,5mm	P	-	M3-3130	
100x250 . 39,4"x98,4"	5,5mm	NR	-	M3-3530	
	5,5mm	P	-	M3-3830	
100x300 . 39,4"x118"	5,5mm	NR	-	M3-4230	
	5,5mm	P	-	M3-4630	

**linea prestige**  
collection



LINEA					
50x100 . 19,6"x39,4"	5,5mm	NR	-	M3-1930	
	5,5mm	P	-	M3-2330	
100x100 . 39,4"x39,4"	5,5mm	NR	-	M3-2730	
	5,5mm	P	-	M3-3130	
100x250 . 39,4"x98,4"	5,5mm	NR	-	M3-3530	
	5,5mm	P	-	M3-3830	
100x300 . 39,4"x118"	5,5mm	NR	-	M3-4230	
	5,5mm	P	-	M3-4630	



LINEA					
50x100 . 19,6"x39,4"	5,5mm	NR	-	M3-1930	
	5,5mm	P	-	M3-2330	
100x100 . 39,4"x39,4"	5,5mm	NR	-	M3-2730	
	5,5mm	P	-	M3-3130	
100x250 . 39,4"x98,4"	5,5mm	NR	-	M3-3530	
	5,5mm	P	-	M3-3830	
100x300 . 39,4"x118"	5,5mm	NR	-	M3-4230	
	5,5mm	P	-	M3-4630	

index

colour map

collections

**linea collections**

cosmos

endless

magnetic

**prestige**

pure stone

slabstone

subway

time 2.0

tool

useful information

Products with a polished finish are more sensitive to abrasion and stains, what requires special conditions. Please see page 348 in chapter 09.  
Les produits à finition polie sont plus sensibles à l'abrasion et aux taches, ce qui requiert des conditions particulières. Veuillez-vous consulter la page 348 du chapitre 09.  
Produkte mit einer polierten Oberfläche sind empfindlicher gegen Abrieb und Fleckenbildung, was besondere Bedingungen erfordert. Bitte beachten Sie Seite 348 in Kapitel 09.  
Os produtos com acabamento polido são mais sensíveis à abrasão e às manchas, o que requer condições especiais. Por favor consulte a página 348 no capítulo 09.

**PROTECT**

Antibacterial for Life.

Available only in natural rectified and polished finishes.  
Uniquement disponible dans les finitions naturel rectifié et poli.  
Nur auf rektifiziert naturbelassen und poliert erhältlich.  
Disponível unicamente nos acabamentos natural retificado e polido.





294

general catalogue . 2023

295

general catalogue . 2023

white LSL1 50x100 . 100x300 NR . beige LSL2 50x100 . 100x100 NR . tortora LSL3 50x100 . 100x100 NR

LAMINATED  
PORCELAIN  
STONEWARE

# linea slabstone

collection —  
P. 171

↓  
DOWNLOAD  
CATALOGUE  
LINEA

↓  
DOWNLOAD  
TECHNICAL  
FEATURES

🌐  
VIEW  
ONLINE

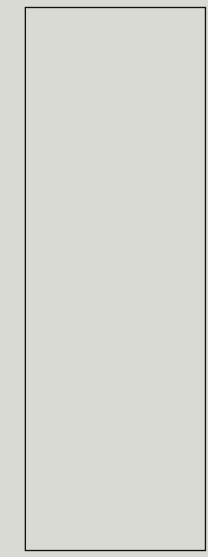

100x300  
NR 3,5mm

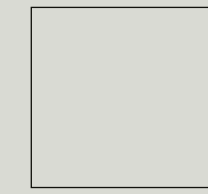

100x100  
NR 3,5mm



50x100  
NR 3,5mm

rectified products . produits rectifiés . rektifizierete produkte . produtos retificados



white  
LSL1

beige  
LSL2

tortora  
LSL3

light grey  
LSL4

grey  
LSL5

UGL V2 R9

**PR( )TECT®**  
Antibacterial for Life.

**MARGRES**  
CERAMIC TILES

index —

colour map —

collections —

**linea collections** —

cosmos

endless

magnetic

prestige

pure stone

slabstone

subway

time 2.0

tool

useful information —



linea slabstone  
collection

linea slabstone  
collection

index

colour map

collections

linea collections

cosmos

endless

magnetic

prestige

pure stone

slabstone

subway

time 2.0

tool

useful information

296

general catalogue . 2023

297

general catalogue . 2023

beige LSL2 100x300 NR . 100x100 NR . white LSL1 100x100 NR



**linea slabstone**

collection



298

general catalogue . 2023

**linea slabstone**

collection



299

general catalogue . 2023

grey LSL5 100x300 NR . light grey LSL4 100x300 NR . 100x100 NR

index

colour map

collections

**linea collections**

cosmos

endless

magnetic

prestige

pure stone

**slabstone**

subway

time 2.0

tool

useful information



linea slabstone  
collection

linea slabstone  
collection

index

colour map

collections

linea collections

cosmos

endless

magnetic

prestige

pure stone

slabstone

subway

time 2.0

tool

useful information

300

general catalogue . 2023

301

general catalogue . 2023



## linea slabstone

collection

white LSL1 NR



### LINEA

50x100 . 19,6"x39,4"	3,5mm	NR	R9	M3-0930
100x100 . 39,4"x39,4"	3,5mm	NR	R9	M3-1230
100x300 . 39,4"x118"	3,5mm	NR	R9	M3-1530

beige LSL2 NR



### LINEA

50x100 . 19,6"x39,4"	3,5mm	NR	R9	M3-0930
100x100 . 39,4"x39,4"	3,5mm	NR	R9	M3-1230
100x300 . 39,4"x118"	3,5mm	NR	R9	M3-1530

tortora LSL3 NR



### LINEA

50x100 . 19,6"x39,4"	3,5mm	NR	R9	M3-0930
100x100 . 39,4"x39,4"	3,5mm	NR	R9	M3-1230
100x300 . 39,4"x118"	3,5mm	NR	R9	M3-1530

## linea slabstone

collection

light grey LSL4 NR



### LINEA

50x100 . 19,6"x39,4"	3,5mm	NR	R9	M3-0930
100x100 . 39,4"x39,4"	3,5mm	NR	R9	M3-1230
100x300 . 39,4"x118"	3,5mm	NR	R9	M3-1530

grey LSL5 NR



### LINEA

50x100 . 19,6"x39,4"	3,5mm	NR	R9	M3-0930
100x100 . 39,4"x39,4"	3,5mm	NR	R9	M3-1230
100x300 . 39,4"x118"	3,5mm	NR	R9	M3-1530

index

colour map

collections

linea collections

cosmos

endless

magnetic

prestige

pure stone

slabstone

subway

time 2.0

tool

useful information

302

303

general catalogue . 2023

general catalogue . 2023





304

general catalogue . 2023

white LSW1 100x100 NR

LAMINATED  
PORCELAIN  
STONEWARE

# linea subway

collection —  
P. 191

↓  
DOWNLOAD  
CATALOGUE

↓  
DOWNLOAD  
TECHNICAL  
FEATURES

🌐  
VIEW  
ONLINE

▶  
ENJOY THE  
VIDEO



100x300  
NR 3,5mm

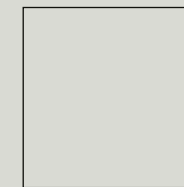

100x100  
NR 3,5mm



50x100  
NR 3,5mm

rectified products . produits rectifiés . rektifizierete produkte . produtos retificados



white  
LSW1

ash  
LSW2

clay  
LSW3

smoke  
LSW4

UGL V2 R9

**PR( )TECT®**

Antibacterial for Life.

**MARGRES**  
CERAMIC TILES

305

general catalogue . 2023

index —

colour map —

collections —

**linea collections** —

cosmos

endless

magnetic

prestige

pure stone

slabstone

subway

time 2.0

tool

useful information —





306

general catalogue . 2023



307

general catalogue . 2023

ash LSW2 100x300 . 100x100 NR

index

colour map

collections

linea collections

cosmos

endless

magnetic

prestige

pure stone

slabstone

subway

time 2.0

tool

useful information





308

general catalogue . 2023



309

general catalogue . 2023

white LSW1 100x300 NR . smoke LSW4 100x100 NR

index

colour map

collections

linea collections

cosmos

endless

magnetic

prestige

pure stone

slabstone

subway

time 2.0

tool

useful information





clay LSW3 100x300 . 50x100 NR . clay SW3 60x60 E ASR



## linea subway

collection

white LSW1



NR

### LINEA

50x100 . 19,6"x39,4"	3,5mm	NR	R9	M3-0930
100x100 . 39,4"x39,4"	3,5mm	NR	R9	M3-1230
100x300 . 39,4"x118"	3,5mm	NR	R9	M3-1530

clay LSW3



NR

### LINEA

50x100 . 19,6"x39,4"	3,5mm	NR	R9	M3-0930
100x100 . 39,4"x39,4"	3,5mm	NR	R9	M3-1230
100x300 . 39,4"x118"	3,5mm	NR	R9	M3-1530

## linea subway

collection

NR

ash LSW2

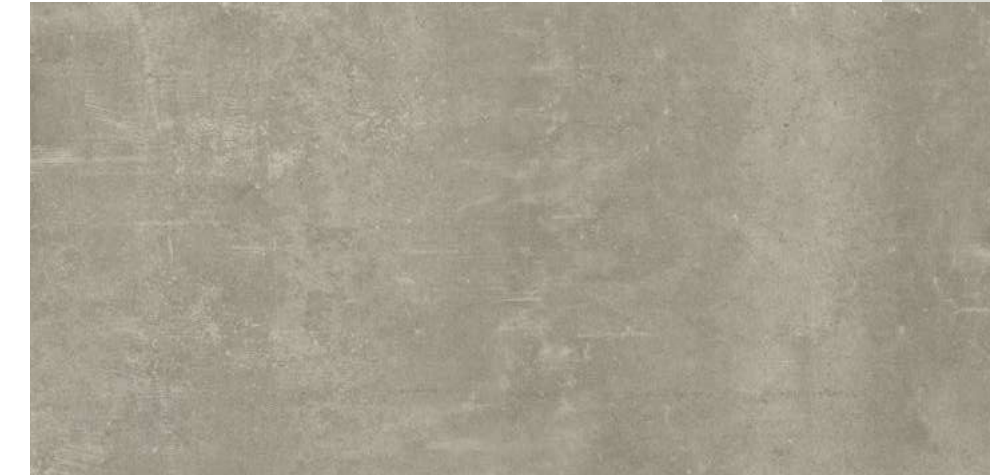

NR

smoke LSW4



### LINEA

50x100 . 19,6"x39,4"	3,5mm	NR	R9	M3-0930
100x100 . 39,4"x39,4"	3,5mm	NR	R9	M3-1230
100x300 . 39,4"x118"	3,5mm	NR	R9	M3-1530

### LINEA

50x100 . 19,6"x39,4"	3,5mm	NR	R9	M3-0930
100x100 . 39,4"x39,4"	3,5mm	NR	R9	M3-1230
100x300 . 39,4"x118"	3,5mm	NR	R9	M3-1530

312

general catalogue . 2023

313

general catalogue . 2023

index

colour map

collections

linea collections

cosmos

endless

magnetic

prestige

pure stone

slabstone

subway

time 2.0

tool

useful information

**MARGRES**  
CERAMIC TILES

**PROTECT**  
Antibacterial for Life.





314

general catalogue . 2023

silver LT26 100x100 NR

LAMINATED  
PORCELAIN  
STONEWARE

# linea time 2.0

collection —  
P. 201

↓  
DOWNLOAD  
CATALOGUE

↓  
DOWNLOAD  
TECHNICAL  
FEATURES

🌐  
VIEW  
ONLINE

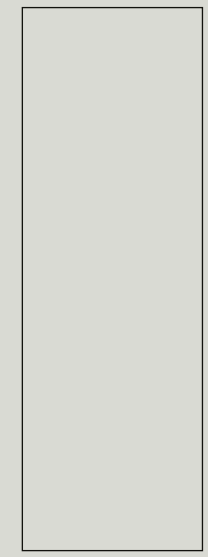

100x300  
NR 3,5mm

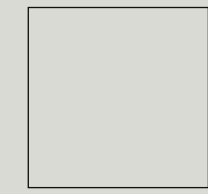

100x100  
NR 3,5mm



50x100  
NR 3,5mm

rectified products . produits rectifiés . rektifizierete produkte . produtos retificados

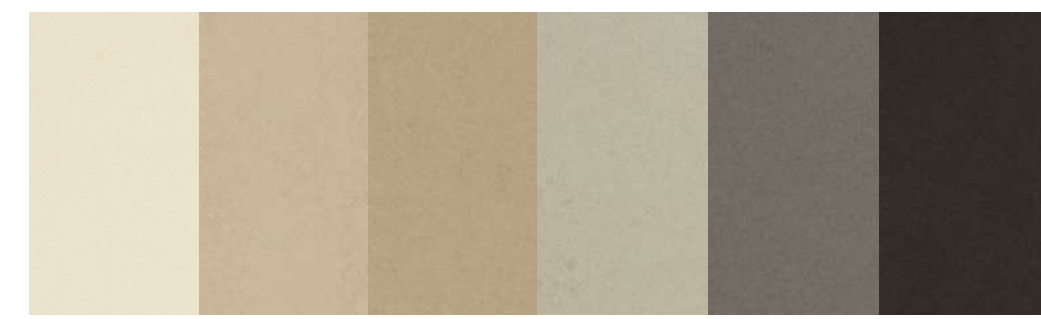

snow LT21    cream LT23    beige LT24    silver LT26    carbon LT28    black LT29

UGL V1 R9

**PR( )TECT®**  
Antibacterial for Life.

**MARGRES**  
CERAMIC TILES

315

general catalogue . 2023

index

colour map

collections

linea collections

cosmos

endless

magnetic

prestige

pure stone

slabstone

subway

time 2.0

tool

useful information



linea time 2.0

— collection

linea time 2.0

— collection

index

—

colour map

—

collections

—

linea collections

—

cosmos

endless

magnetic

prestige

pure stone

slabstone

subway

time 2.0

tool

useful information

—

316

general catalogue . 2023

317

general catalogue . 2023

black LT29 100x100 NR



linea time 2.0

collection



snow LT21 100x100 . cream LT23 100x300 NR

linea time 2.0

collection



cream LT23 50x100 NR

index

colour map

collections

linea collections

cosmos

endless

magnetic

prestige

pure stone

slabstone

subway

**time 2.0**

tool

useful information



## linea time 2.0

collection

snow LT21

NR

### LINEA

50x100 . 19,6"x39,4"	3,5mm	NR	R9	M3-0930
100x100 . 39,4"x39,4"	3,5mm	NR	R9	M3-1230
100x300 . 39,4"x118"	3,5mm	NR	R9	M3-1530

cream LT23

NR

### LINEA

50x100 . 19,6"x39,4"	3,5mm	NR	R9	M3-0930
100x100 . 39,4"x39,4"	3,5mm	NR	R9	M3-1230
100x300 . 39,4"x118"	3,5mm	NR	R9	M3-1530

beige LT24

NR

### LINEA

50x100 . 19,6"x39,4"	3,5mm	NR	R9	M3-0930
100x100 . 39,4"x39,4"	3,5mm	NR	R9	M3-1230
100x300 . 39,4"x118"	3,5mm	NR	R9	M3-1530

## linea time 2.0

collection

NR

silver LT26

### LINEA

50x100 . 19,6"x39,4"	3,5mm	NR	R9	M3-0930
100x100 . 39,4"x39,4"	3,5mm	NR	R9	M3-1230
100x300 . 39,4"x118"	3,5mm	NR	R9	M3-1530

NR

carbon LT28

### LINEA

50x100 . 19,6"x39,4"	3,5mm	NR	R9	M3-0930
100x100 . 39,4"x39,4"	3,5mm	NR	R9	M3-1230
100x300 . 39,4"x118"	3,5mm	NR	R9	M3-1530

NR

black LT29

### LINEA

50x100 . 19,6"x39,4"	3,5mm	NR	R9	M3-0930
100x100 . 39,4"x39,4"	3,5mm	NR	R9	M3-1230
100x300 . 39,4"x118"	3,5mm	NR	R9	M3-1530

index

colour map

collections

linea collections

cosmos

endless

magnetic

prestige

pure stone

slabstone

subway

time 2.0

tool

useful information

320

321

general catalogue . 2023

general catalogue . 2023

**MARGRES**  
CERAMIC TILES

**PROTECT**  
Antibacterial for Life.



# useful information

informations utiles . technische information . informações úteis —

calibers calibres kaliber calibres	P. 356
certification certification zertifizierung certificação	P. 330
general sales conditions conditions générales de vente allgemeine verkaufsbedingungen condições gerais de venda	P. 360
important notes notes importantes wichtige hinweise notas importantes	P. 367
margres green	P. 328
laying suggestions suggestions de pose anwendungsvorschläge sugestões de aplicação	P. 359
outdoor extra thick	P. 338
package emballage verpackung embalagem	P. 354
pr()tect	P. 324
symbols symbologie zeichen simbologia	P. 358
technical information information technique technische information informação técnica	P. 342
think zero	P. 326

323

general catalogue . 2023

index

colour map

collections

linea collections

useful information

calibers

certification

general sales  
conditions

important notes

magres green

laying suggestions

outdoor extra thick

package

pr()tect

symbols

technical information

think zero



# PR( )TECT®

Antibacterial for Life.

An exclusive line of extremely high performance antimicrobial floor and wall tiles, designed for healthy, safe and protected living spaces.  
Une ligne exclusive de sols et revêtements antibactériens aux performances très élevées, pour un habitat sain, sûr et protégé.  
Eine exklusive Linie an hochwertigen Fußböden und antibakteriellen Wandverkleidungen, für ein gesundes, sicheres und geschütztes Leben.  
Uma linha exclusiva de pavimentos e revestimentos antimicrobianos de altíssima performance, projetada para ambientes saudáveis, seguros e protegidos.



## powerful action

eliminates up to 99.9% of bacteria and prevents their reproduction

## action puissante

élimine jusqu'à 99,9% des bactéries et empêche leur prolifération

## leistungsstarke wirkung

eliminiert bis zu 99,9% Bakterien und ihre Verbreitung verhindern.

## ação potente

elimina até 99,9% das bactérias e impede a sua reprodução



## continuous protection

always active, 24 hours a day, with or without sunlight

## protection continue

toujours actif, 24 heures sur 24 avec ou sans lumière naturelle

## dauerschutz

immer aktiv, Rund um die Uhr, mit oder ohne Sonnenlicht

## proteção contínua

permanente ativo, 24 horas por dia, com ou sem luz solar



## eternal effectiveness

thanks to technology integrated into the product

## efficacité permanente

grâce à la technologie intégrée dans le produit

## dauerhafte wirksamkeit

dank der im Produkt integrierten Technologie

## eficácia permanente

graças à tecnologia incorporada no produto



## guaranteed quality

by the partnership with Microban®

## qualité garantie

en partenariat avec Microban®

## garantierte qualität

dank der Partnership mit Microban®

## qualidade garantida

em parceria com a Microban®



## the safest place in the world

continuous active antibacterial action

- We have chosen Microban®, the global leader in antibacterial technology, to make our tiles even safer.
- There are more bacteria on one hand than people on the Earth.
- Bacterial growth can double in number every 20 minutes on unprotected surfaces.

Floors in areas with high levels of pedestrian traffic, such as schools, offices, hospitals and public buildings are ideal places for microbial and bacterial growth, but our homes, despite daily cleaning, can also be contaminated by germs and bacteria from outside.

Margres always offers the highest quality products, together with unparalleled beauty and cutting-edge solutions.

Today, thanks to ongoing work at the Panariagroup Research Centre and a prestigious agreement with the global leader in antibacterial technology Microban®, we are proud to announce that Margres porcelain stoneware, produced with Microban® technology, are designed with something more than beauty and durability in mind: biological health and safety for our living, leisure and working environments.

Thanks to built-in technology based on silver, our tiles are protected by an innovative antibacterial shield that eliminates up to 99.9% of bacteria on surfaces and guarantees long-lasting protection against wear and tear, climatic conditions and repeated cleans in any usage environment.

Microban silver technology is notified with the Biocidal Products Directive (BPD) under the appropriate product types as required by the EU Biocidal Products Directive, 98/8/EC.

In addition, Microban® technology is active 24 hours a day, guaranteeing continuous protection day and night, keeping tiles more hygienic in between cleans.

## l'endroit le plus sûr au monde

action antibactérienne active en permanence

- Nous avons choisi Microban®, le leader mondial en technologie antibactérienne, pour rendre nos carrelages encore plus sûrs.
- Il y a plus de bactéries sur une main que d'habitants sur la terre.
- Sur les surfaces non protégées, la prolifération des bactéries peut se multiplier par deux toutes les 20 minutes.

Les sols des zones à fort passage de piétons, comme par exemple, les écoles, bureaux, hôpitaux et bâtiments publics, sont des endroits qui se prêtent à la prolifération microbienne et bactérienne, mais, malgré un nettoyage quotidien, nos foyers peuvent aussi être contaminés par des germes et des bactéries venant de l'extérieur.

Margres propose toujours des produits de la plus haute qualité, alliés à une beauté hors pair et des solutions à la pointe de la technologie.

À l'heure actuelle, grâce aux travaux continus du Panariagroup Research Centre, et à un contrat prestigieux avec Microban®, le leader mondial en technologie antibactérienne, nous sommes fiers d'annoncer que les carrelages en grès cérame pleine masse Margres, produits en incorporant la technologie Microban®, sont conçus en recherchant quelque chose de plus que l'esthétique et la durabilité, à savoir la santé et la sûreté biologiques pour nos espaces de vie, de loisirs et de travail.

Grâce à la technologie incorporée basée sur l'argent, nos carrelages sont protégés par un bouclier antibactérien innovateur qui élimine jusqu'à 99,9% des bactéries sur les surfaces et garantit une protection durable contre l'usure, les conditions climatiques et les nettoyages à répétition dans tous les lieux d'utilisation.

La technologie à base d'argent Microban est notifiée avec la Directive sur les produits biocides (Biocidal Products Directive, BPD) sous les types de produits appropriés tel que requis par la Directive européenne sur les produits biocides, 98/8/EC.

Par ailleurs, la technologie Microban® reste active 24 heures par jour, ce qui garantit une protection ininterrompue jour et nuit, maintenant les carrelages dans un état plus hygiénique entre les nettoyages.

## der sicherste ort der welt

die aktive antibakterielle aktion geht weiter

- Wir haben uns für Microban®, den Weltmarktführer in antibakterieller Technologie entschieden, um unsere Mosaik noch sicherer zu machen.
- In der Fläche einer Hand leben mehr Bakterien als Menschen auf der Erde.
- Bakterielles Wachstum kann sich auf ungeschützten Oberflächen alle 20 Minuten verdoppeln.

Fußböden in Bereichen mit hohem Fußgängeraufkommen wie Schulen, Büros, Krankenhäusern und öffentlichen Gebäuden sind ideale Orte für mikrobisches und bakterielles Wachstum, und sogar unsere Wohnungen können trotz täglicher Reinigung durch Erreger und Bakterien von außen verseucht sein. Margres-Produkte bieten immer höchste Qualität in Verbindung mit unerreichter Schönheit und bahnbrechenden Lösungen.

Heute geben wir, dank der andauernden Forschungsarbeit des Panariagroup Research Centre und einem Übereinkommen mit Microban®, dem Weltmarktführer in antibakterieller Technologie bekannt, dass die anhand der Microban® -Technologie gefertigten Margres-Mosaik mehr als nur Schönheit und Strapazierfähigkeit verkörpern: Gesundheit und biologische Sicherheit für unsere Wohn-, Freizeit- und Arbeitsbereiche.

Dank der silberbasierten Technologie sind unsere Mosaik durch eine innovative antibakterielle Barriere geschützt, die bis zu 99,9% der Bakterien an der Oberfläche eliminiert und einen dauerhaften Schutz gegen Abnutzung, Witterung und wiederholte Reinigung in jeglichem Einsatzumfeld bietet.

Die Microban Silbertechnologie wurde gemäß der Anforderungen der EU-Richtlinie für Biozid-Produkte (98/8/CE) unter dem Schutz der Richtlinie für Biozid-Produkte (BPD, Biocidal Product Directive) registriert.

Außerdem ist die Microban®-Technologie 24 Stunden am Tag aktiv und garantiert auf diese Weise Tag- und Nachtschutz, indem sie die Mosaik zwischen den Putzvorgängen hygienisch hält.

## o local mais seguro do mundo

ação antibacteriana ativa contínua

- Escolhemos o Microban®, o líder global em tecnologia antibacteriana, para tornar os nossos mosaicos ainda mais seguros.
- Há mais bactérias numa mão do que pessoas na Terra.
- O crescimento bacteriano pode duplicar de número a cada 20 minutos, em superfícies não protegidas.

Os pavimentos das áreas com elevados níveis de tráfego pedestre, tais como escolas, escritórios, hospitais e edifícios públicos são locais ideais para o crescimento microbiano e bacteriano, mas as nossas casas, apesar da limpeza diária, também podem ser contaminadas por germes e bactérias do exterior. A Margres oferece sempre produtos da mais elevada qualidade, aliados a uma beleza inigualável e soluções de vanguarda.

Atualmente, graças ao trabalho contínuo no Panariagroup Research Centre de um acordo prestigioso com a Microban®, o líder global em tecnologia antibacteriana, temos o orgulho de anunciar que os mosaicos Margres, produzidos com a tecnologia Microban®, são concebidos tendo em mente algo mais do que a beleza e durabilidade: ainda mais saúde e segurança biológica para os nossos ambientes domésticos, de lazer e trabalho.

Grças à tecnologia incorporada com base de prata, os nossos mosaicos estão protegidos por uma barreira antibacteriana inovadora que elimina até 99,9% das bactérias na superfície e garante uma proteção duradoura contra o desgaste, condições climáticas e limpezas repetidas em qualquer ambiente de utilização. A tecnologia de prata Microban foi registada junto da Diretiva de Produtos Biocidas (BPD, Biocidal Product Directive), sob os tipos de produto adequados conforme requerido pela Diretiva de Produtos Biocidas da UE, 98/8/CE. Além disso, a tecnologia Microban® está ativa 24 horas por dia, garantindo proteção contínua dia e noite, mantendo os mosaicos mais higiénicos entre as limpezas.

index

colour map

collections

linea collections

useful information

calibers

certification

general sales conditions

important notes

magres green

laying suggestions

outdoor extra thick

package

pr()tect

symbols

technical information

think zero





### an action to be tangible has to start from the basics, from the spaces we live in, from the decisions we make

At the global level, buildings, homes, and the construction sector are today responsible for approximately 36% of the world's total energy consumption and 37% of all CO2 emissions related to energy\*. Within this context, the construction sector can and must contribute to accelerating decarbonisation and developing alternative, low-CO2 emission, solutions in an effort to achieve zero emissions by 2050. That's why choosing the right materials for residential, commercial, and public spaces is instrumental to decreasing our environmental impact. Today, clients and designers must be increasingly meticulous when selecting construction materials and techniques, if there is to be any hope of achieving the Paris Agreement's objective of limiting global warming to 1.5°C. \*2021 GLOBAL STATUS REPORT FOR BUILDINGS AND CONSTRUCTION, Global Alliance for Buildings and Constructions

### Pour être tangible, une action doit partir de la base, des espaces dans lesquels nous vivons, des décisions que nous prenons

A l'échelle mondiale, les bâtiments, les habitations et le secteur de la construction sont aujourd'hui responsables d'environ 36 % de la consommation totale d'énergie dans le monde et de 37 % de toutes les émissions de CO2 liées à l'énergie\*. Dans ce contexte, le secteur de la construction peut et doit contribuer à l'accélération de la décarbonisation et au développement de solutions alternatives à faible émission de CO2, dans le but d'atteindre l'objectif de zéro émission d'ici 2050. C'est pourquoi choisir les bons matériaux pour les espaces résidentiels, commerciaux et publics est essentiel pour réduire notre impact sur l'environnement. Aujourd'hui, les maîtres d'ouvrage et les concepteurs doivent être de plus en plus méticuleux dans le choix des matériaux et des techniques de construction, s'ils veulent avoir un espoir d'atteindre l'objectif de l'Accord de Paris, qui consiste à limiter le réchauffement de la planète à 1,5°C. \*RAPPORT D'ÉTAPE GLOBAL 2021 SUR LES BÂTIMENTS ET LA CONSTRUCTION, Alliance mondiale pour les bâtiments et les constructions.

### we reduce the distance between us and zero impact, reducing everything in between

nous réduisons la distance qui nous sépare de l'impact zéro, en réduisant tout ce qui se trouve entre les deux . wir verringern den Abstand zwischen uns und der Nullbelastung und reduzieren alles, was dazwischen liegt. diminuímos a distância entre nós e o impacto zero, reduzindo tudo o que está no meio



**-65%**  
consumption of raw materials  
consommation de matières premières  
Verbrauch von Rohstoffen  
consumo de matérias primas



**-80%**  
consumption of water  
consommation d'eau  
Wasserverbrauch  
consumo de água



**-30%**  
consumption of energie  
consommation d'énergie  
Energieverbrauch  
o consumo de energia



**-30%**  
CO2 emissions in the atmosphere  
CO2 émissions dans l'atmosphère  
CO2 Emissionen in die Atmosphäre  
CO2 emissões na atmosfera.



**-66%**  
pollution caused by transport  
pollution produite par les transports  
transportbedingte Umweltverschmutzung  
poluição causada pelos transportes

The data refers to ultra-thin slabs when compared to standard-thickness porcelain stoneware tile . Les données se rapportent aux dalles ultrafines par rapport aux carreaux en grès cérame d'épaisseur standard . Die Daten beziehen sich auf ultradünne Platten im Vergleich zu Fliesen aus Feinsteinzeug mit Standarddicke . Os dados reportam-se a lajes ultrafinas, quando comparadas com mosaicos em grés porcelânico de espessura

### our ultra-thin slabs. the most sustainable ceramic surface in the world with co2 compensated 100%

Our ultra-thin slabs are born sustainable, but we didn't stop there. Because we've worked to reduce the CO2 emissions generated by their production and compensate for residual emissions as well. To go beyond. To achieve a zero-impact production, well beyond legal requirements. Thus creating ultra-thin slabs that compensate for 100% of their CO2 emissions is the world's most sustainable ceramic surface! The thinnest tile on the market, at 3mm thick, is a testament to Panariagroup's leadership in the innovation of ceramic's natural sustainability.

### unsere ultradünnen Platten. die nachhaltigste keramische oberfläche der welt mit 100% CO2-Kompensation

Unsere ultradünnen Platten werden bereits nachhaltig produziert, aber das war noch nicht alles. Denn wir haben daran gearbeitet, die bei ihrer Herstellung entstehenden CO2-Emissionen zu reduzieren und auch die verbleibenden Emissionen zu kompensieren. Um darüber hinauszugehen. Um eine umweltfreundliche Null-Emissionen-Produktion zu erreichen, die weit über die gesetzlichen Anforderungen hinausgeht. So haben wir ultradünne Platten geschaffen, die 100 % ihrer CO2-Emissionen kompensieren: die nachhaltigste Keramikoberfläche der Welt! Die dünnste Fliese auf dem Markt mit einer Dicke von 3 mm ist ein Beweis für die innovationsführende Rolle der Panariagroup im Bereich der natürlichen Nachhaltigkeit von Keramik.

### nos dalles ultra-minces. la surface céramique la plus durable au monde avec une compensation de CO2 à 100%.

Nos dalles ultra-minces sont déjà produites de manière durable, mais nous ne nous sommes pas arrêtés là. Car nous avons travaillé pour réduire les émissions de CO2 générées par leur production et compenser également les émissions résiduelles. Pour aller plus loin. Pour atteindre une production à impact zéro, en allant bien au-delà des exigences légales. En créant ainsi des dalles ultra-minces qui compensent 100 % de leurs émissions de CO2, nous avons créé la surface céramique la plus durable du monde! La mosaïque la plus fine du marché, d'une épaisseur de 3 mm, témoigne du leadership de Panariagroup en matière d'innovation dans le domaine de la durabilité naturelle de la céramique.

### as nossas lajes ultra-finas. a superfície cerâmica mais sustentável do mundo, com 100% de compensação de CO2.

As nossas lajes ultrafinas já são produzidas de forma sustentável, mas não nos ficámos por aí, uma vez que trabalhamos no sentido de reduzir as emissões de CO2 geradas pela sua produção e também de compensar as emissões residuais. Para ir mais além. Para alcançar uma produção com impacto zero, ultrapassando largamente os requisitos legais. Assim, a criação de lajes ultrafinas que compensam em 100% as suas emissões de CO2 significa a criação da superfície cerâmica mais sustentável do mundo! O mosaico mais fino do mercado, com 3mm de espessura, é um testemunho da liderança da Panariagroup na inovação da sustentabilidade natural da cerâmica.

### Eine Aktion, die greifbar sein soll, muss bei den Grundlagen beginnen, bei den Räumen in denen wir leben, von den Entscheidungen, die wir treffen

Auf globaler Ebene sind Gebäude, Wohnungen und der Bausektor heute für etwa 36 % des weltweiten Gesamtenergieverbrauchs und 37 % aller energiebedingten CO2-Emissionen verantwortlich\*. In diesem Zusammenhang kann und muß der Bausektor dazu beitragen, die Dekarbonisierung zu beschleunigen und alternative Lösungen mit geringen CO2-Emissionen zu entwickeln, um bis zum Jahr 2050 Null-Emissionen zu erreichen. Deshalb ist die Wahl der richtigen Materialien für Wohn-, Geschäfts- und öffentliche Räume entscheidend für die Verringerung unserer Umweltbelastung. Heutzutage, müssen Bauherren und Planer bei der Auswahl von Baumaterialien und -techniken immer sorgfältiger vorgehen, wenn das Ziel des Pariser Abkommens, die globale Erwärmung auf 1,5 °C zu begrenzen, erreicht werden soll. \*BERICHT ÜBER DIE GLOBALE SITUATION IM JAHR 2021 FÜR GEBÄUDE UND BAUWESEN, Globale Allianz für Gebäude und Bauwesen.

### uma acção para ser tangível tem de começar a partir do que é básico, dos espaços em que vivemos, das decisões que tomamos

A nível global, os edifícios, as casas e o setor da construção são hoje em dia responsáveis por aproximadamente 36% do consumo total de energia a nível mundial e por 37% de todas as emissões de CO2 relacionadas com energia\*. Neste contexto, o setor da construção pode e tem de contribuir para acelerar a descarbonização e desenvolver soluções alternativas, com baixas emissões de CO2, num esforço para se alcançar zero emissões até 2050. É por isso que a escolha dos materiais corretos para espaços residenciais, comerciais e públicos é fundamental para diminuir o nosso impacto ambiental. Actualmente, os clientes e projetistas têm de ser cada vez mais meticolosos na selecção de materiais e técnicas de construção, para que haja alguma esperança de se alcançar o objetivo do Acordo de Paris de limitar o aquecimento global a 1,5°C. \*RELATÓRIO DA SITUAÇÃO GLOBAL EM 2021 RELATIVA A EDIFÍCIOS E CONSTRUÇÃO, Aliança Global para Edifícios e Construções.





## inhabit the present live the future

Margres creates ceramic collections to live the present and the future, surrounded by beauty, protected by the quality of an exclusive design of living in total freedom. The same beauty and marvelous harmony that we dream for the world around us.

For this, Margres creates and protects, by reducing to its minimum the environmental impact coming from its activity, through the constant research of the total eco-sustainability in the working environment, on the materials used and in the productive processes, as the obtained environmental certificates demonstrate. We want to contribute for a better world and only what is really eco-sustainable can be considered as development with future vision...

This is our daily commitment and our social responsibility.

sustainable development	commitments
<b>customer services and relationships with other stakeholders</b>	satisfaction of customers and other interested parties, seeking the internationalization of their brands and products in the various markets;
<b>continuous improvement</b>	innovation and product development anticipating the expectations of its customers and ensuring the sustainability of the products throughout their life cycle;
<b>efficiency</b>	implementation of a culture of operational excellence that maximizes the efficiency of processes;
<b>social goals</b>	involvement and motivation of its employees, since they are an important asset for the success of the company;
<b>environmental protection</b>	environmental protection, including pollution prevention, contributing to the minimization of environmental impacts, and opting, whenever possible and economically viable, for the best available technologies, in order to improve environmental performance;
<b>health, safety and well-being</b>	prevention and minimization of risk to the health and safety of employees in order to contribute to their integrity and quality of life;
<b>relationships with society</b>	compliance with the applicable conformity requirements inherent in its activities, products and services.

## habiter le present vivre l'avenir

Margres crée des collections pour vivre le présent et l'avenir, encadrés par la beauté, protégés par la qualité d'un design exclusif à vivre en toute liberté.

La même beauté et la même harmonie dont nous rêvons pour notre monde. C'est pour cette raison que Margres crée et protège en réduisant le plus possible l'impact environnemental de son activité, à travers la recherche permanente de l'équilibre écologique dans l'environnement de travail, dans les matières utilisées et dans le processus productif, comme le démontrent les certifications environnementales obtenues. Nous voulons contribuer à ce que vous viviez dans un monde plus beau, plus écologique donc plus développé et d'avenir. Ceci est notre compromis quotidien et notre responsabilité sociale.

développement durable	engagements
<b>service clientèle et autres parties intéressées</b>	la satisfaction des clients et des autres parties prenantes, cherchant l'internationalisation de ses marques et produits sur les différents marchés;
<b>amélioration continue</b>	l'innovation et le développement des produits, avec une prévision des attentes de ses clients, en assurant la durabilité des produits tout au long de leur cycle de vie;
<b>efficacité</b>	la mise en œuvre d'une culture d'excellence opérationnelle qui incite à la maximisation de l'efficacité des processus;
<b>sociaux</b>	l'implication et la motivation de ses employés car ils constituent un actif essentiel pour la réussite de l'entreprise;
<b>protection environnementale</b>	la protection de l'environnement, y compris la prévention de la pollution, contribuant ainsi à minimiser les impacts environnementaux, en optant, lorsque possible et économiquement réalisable, pour la meilleure technologie disponible, afin d'améliorer la performance environnementale;
<b>sécurité, santé et bien-être</b>	la prévention et la réduction des risques pour la santé et la sécurité des employés afin de contribuer à leur intégrité et qualité de vie;
<b>rapport avec la société</b>	respect des obligations de conformité applicables, inhérentes à ses activités, produits et services.

## in der gegenwart wohnen, in der zukunft leben

Margres produziert Keramik Kollektionen um in der Gegenwart und der Zukunft zu wohnen, vollkommen in Schönheit, ausgestattet mit der Qualität eines exklusiven Designs, damit Sie in Freiheit leben.

Die gleiche Schönheit und wundervolle Harmonie die wir uns für unsere Umwelt wünschen. Das heißt, dass Margres erschafft und schützt, dabei die Umweltbelastung deren Aktivität auf ein Minimum reduziert, mittels der ständigen Forschung nach der totalen Ökonachhaltigkeit an den Produktionsstätten, den benutzten Materialien, und den Herstellungsprozessen, wie die erlangten Umweltzertifikate darlegen. Wir wollen dazu beitragen in einer besseren Welt zu leben, dabei wissen wir, dass die Ökonachhaltigkeit die Zukunftsentwicklung ist ... Es ist unsere tägliche Anstrengung und soziale Verantwortung.

nachhaltige entwicklung	verpflichtungen
<b>kundenbezogene, aber auch für andere beteiligte zu erbringende leistungen</b>	zufriedenheit der kunden und anderer interessierter beteiligten und streben nach internationalisierung der marken und produkte auf den verschiedenen märkten;
<b>kontinuierliche verbesserungen</b>	innovation und entwicklung der produkte, wobei die erwartungen der kunden vorweggenommen werden, und sicherung der nachhaltigkeit der produkte über den gesamten lebenszyklus hinweg;
<b>effizienz</b>	umsetzung einer kultur der betrieblichen exzellenz, die die maximierung der effizienz der verfahren verstärkt;
<b>betriebsbezogen</b>	einbindung und motivation der mitarbeiter, denn sie stellen die bestimmenden aktiva des unternehmens dar;
<b>umweltschutz</b>	umweltschutz, einschließlich vermeidung von umweltverschmutzung, der zur minimisierung der umweltauswirkungen beiträgt und wo immer dies möglich und wirtschaftlich vertretbar ist, die besten verfügbaren technologien auswählen, um die umwelleistung zu verbessern;
<b>sicherheit, gesundheit und wohlstand</b>	vorbeugung und minimierung der risiken und gefahren für die gesundheit und sicherheit der mitarbeiter, um zur integrität und lebensqualität beizutragen;
<b>firnenbezogen</b>	einhaltung der anwendbaren compliance-verpflichtungen, die mit ihren produkten und dienstleistungen verbunden sind.

## habitar o presente viver o futuro

A Margres, cria coleções cerâmicas para habitar o presente e o futuro, plenas de beleza, dotadas da qualidade de um exclusivo design, para viver em liberdade. A mesma beleza e a mesma maravilhosa harmonia que sonhamos para o mundo em nosso redor. Isto é, a Margres, cria e protege, reduzindo ao mínimo o impacto ambiental da sua atividade, por meio da constante pesquisa da total eco sustentabilidade no local de trabalho, nas matérias utilizadas, e nos processos produtivos, como demonstram as certificações ambientais obtidas. Queremos contribuir para que vivamos num mundo melhor, sabendo que a eco sustentabilidade é desenvolvimento olhando para o futuro...

É o nosso esforço quotidiano e a nossa responsabilidade social.

desenvolvimento sustentável	compromissos
<b>serviço ao cliente e restantes partes interessadas</b>	Satisfação dos clientes e restantes partes interessadas, procurando a internacionalização das suas marcas e produtos nos diversos mercados;
<b>melhoria contínua</b>	Inovação e desenvolvimento dos produtos antecipando as expectativas dos seus clientes e assegurando a sustentabilidade dos produtos ao longo do seu ciclo de vida;
<b>eficiência</b>	Implementação de uma cultura de excelência operacional que potencie a maximização da eficiência dos processos;
<b>sociais</b>	Envolvimento e motivação dos seus colaboradores pois constituem um activo determinante para o sucesso da empresa;
<b>proteção ambiental</b>	Proteção do ambiente, incluindo a prevenção da poluição, contribuindo para a minimização dos impactos ambientais e optando sempre que possível e economicamente viável pelas melhores tecnologias disponíveis, a fim de melhorar e desempenho ambiental;
<b>segurança, saúde e bem-estar</b>	Prevenção e minimização do risco para a saúde e segurança dos colaboradores por forma a contribuir para sua integridade e qualidade de vida;
<b>relação com a sociedade</b>	Cumprimento das obrigações de conformidade aplicáveis inerentes às suas atividades, produtos e serviços.



# certification

certification . zertifizierung . certificação



The GREENGUARD brand certifies products that guarantee the highest standards of indoor air quality.

All MARGRES collections in porcelain stoneware, monoporous and laminated stoneware have obtained the GREENGUARD GOLD certification, that is, the UL standard with the strictest limits on VOC (Volatile Organic Compounds) emissions, thus being in a position to guarantee the best health conditions for people who live and dwell in indoor spaces. Therefore, they can be used in environments such as schools and healthcare facilities, frequented by sensitive people, such as children and the elderly.

GREENGUARD GOLD is a widely recognised certification, required by sustainable construction programmes and by design and construction regulations around the world, such as LEED (international) and BREEAM (UK).

La marque GREENGUARD certifie des produits qui garantissent les plus hauts standards de qualité de l'air dans les espaces intérieurs.

Toutes les collections MARGRES en grès cérame, monoporeuse et grès laminé ont obtenu la certification GREENGUARD GOLD, c'est-à-dire, la norme UL avec les limites les plus strictes d'émissions de COV (composés organiques volatils), étant ainsi en mesure de garantir les meilleures conditions sanitaires aux personnes qui vivent et habitent les espaces intérieurs. Ils peuvent donc être utilisés dans des environnements tels que les écoles et les établissements de santé, fréquentés par des personnes sensibles, comme les enfants et les personnes âgées.

GREENGUARD GOLD est une certification largement reconnue et exigée par les programmes de construction durable et les réglementations de conception et de construction dans le monde entier, telles que LEED (international) et BREEAM (Royaume-Uni).

Die Marke GREENGUARD zertifiziert Produkte, die die höchsten Standards der Luftqualität in Innenräumen garantieren.

Alle MARGRES-Kollektionen aus Feinsteinzeug, Monoporös und laminiertem Feinsteinzeug haben die GREENGUARD GOLD-Zertifizierung erhalten, d.h. die UL-Norm mit den strengsten Grenzwerten für FOV-Emissionen (Flüchtiger Organischer Verbindungen) und sind somit in der Lage, die besten Gesundheitsbedingungen für Menschen, die in Innenräumen leben und wohnen, zu gewährleisten. Daher, können sie in Umgebungen wie Schulen und Gesundheitseinrichtungen eingesetzt werden, die von empfindlichen Menschen wie Kindern und älteren Menschen frequentiert werden.

GREENGUARD GOLD ist eine Zertifizierung, die weithin anerkannt und von nachhaltigen Bauprogrammen und Design- und Bauvorschriften auf der ganzen Welt gefordert wird, wie LEED (international) und BREEAM (UK).

A marca GREENGUARD certifica produtos que garantem os mais elevados padrões de qualidade do ar em espaços interiores.

Todas as coleções MARGRES em grés porcelânico, monoporosa e grés laminado obtiveram a certificação GREENGUARD GOLD, ou seja, a norma UL com os mais rigorosos limites relativos às emissões de COV (Compostos Orgânicos Voláteis), estando, assim, em condições de garantir as melhores condições de salubridade às pessoas que vivem e habitam espaços interiores. Por conseguinte, podem ser utilizadas em ambientes como escolas e estabelecimentos de saúde, frequentados por pessoas sensíveis, como crianças e idosos.

A GREENGUARD GOLD é uma certificação amplamente reconhecida e exigida pelos programas de construção sustentável e pelos regulamentos de projeto e construção em todo o mundo, tais como o LEED (internacional) e o BREEAM (Reino Unido).

## cutting-edge technology

Each raw material used, each productive process and each technology of the complex activity of the Margres sites are studied in order to reduce the environmental impact, by saving, recycling, filtering, with the will of transforming the waste in resources and optimize the use of energy. Margres is on the cutting-edge of adopting ecologically sustainable practices and this is demonstrated by the most accurate controls, repeated on a daily basis.

## spitzentechnologie

Jeder benutzte natürliche Rohstoff, jeder Herstellungsprozess und jede Technologie der komplexen Aktivität in den Industriesektoren der Margres werden studiert, um dabei die Umweltbelastung zu reduzieren, zu sparen und zu recyklieren (verwerten), mit dem Willen, den Abfall in Ressourcen umzuwandeln und den Gebrauch der erzeugten Energie zu optimieren. Margres ist an der Spitze in der Anpassung der nachhaltigen ökologischen Maßnahmen, welche durch die sorgfältigen Kontrollen, die jeden Tag durchgeführt werden, dargestellt werden.



reused non-fired material  
réutilisation du tesson  
wiederverwendung unbearbeiteter scherben  
reutilização de caco cru



recycling of fired material  
recyclage du tesson cuit  
recycling von erhitzten scherben  
reciclagem de caco cozido



water recycling from the production process  
recyclage des eaux du processus productif  
recycling von in verfahren benutztet wasser  
reciclagem de água do processo



low gas emissions to atmosphere  
faibles émissions de gaz dans l'atmosphère  
geringe abgabe gashaltiger emissionen in die atmosphäre  
baixas emissões gasosas para a atmosfera

# certification

certification . zertifizierung . certificação

## technologie d'avant-garde

Chaque matière première, chaque processus productif et chaque technologie de la complexe activité des établissements de Margres sont étudiés de façon à limiter l'impact environnemental en épargnant, recyclant et filtrant avec la volonté de transformer les déchets en ressources et optimiser l'usage de l'énergie produite. Margres est à l'avant-garde dans l'action et les pratiques pour l'environnement comme le démontrent les contrôles les plus exigeants répétés au quotidien.

## tecnologia de vanguarda

Cada matéria prima natural utilizada, cada processo produtivo e cada tecnologia da complexa atividade das unidades industriais da Margres, são estudadas de forma a minimizar o impacto ambiental, poupando, e reciclando, com a vontade de transformar desperdícios em recursos e otimizar a utilização da energia produzida. A Margres está na vanguarda na adoção de medidas ecologicamente sustentáveis as quais são demonstradas pelos mais minuciosos controles quotidianamente efetuados.



energy saving  
économie d'énergie  
energieeinsparung  
poupança de energia



packing from 100% recycled materials  
100% de matériaux recyclables utilisés dans l'emballage  
100% recycling-material wird für verpackungen benutzt  
100% de materiais recicláveis utilizados na embalagem



ceramic products sustainability  
durabilité des produits céramiques  
nachhaltigkeit von keramikprodukten  
sustentabilidade dos produtos cerâmicos



FAO pallets  
FAO palettes  
FAO paletten  
paletes FAO



# certification

certification . zertifizierung . certificação



# certification

certification . zertifizierung . certificação

## the environment certification

Margres have obtained the most prestigious International environmental certifications. Agencies and control bodies have officially recognized the work done by the company for the safeguarding of the earth's natural resources. These certifications are proof of the high standards attained by Margres, a company which is a forerunner in terms of sustainable development. These are a clear proof of how it is possible to reconcile quality, industrial innovation and design with a serious policy for environmental safeguard.

## la certification environnementale

Les établissements Margres ont obtenu de prestigieuses certifications environnementales internationales. Les entités et les organismes de contrôle ont officiellement reconnu le travail fourni par ces entreprises pour la préservation des ressources naturelles de la planète. Cette certification témoigne des bonnes pratiques environnementales de Margres, dans la protection du développement durable. C'est une démonstration concrète de l'engagement de l'entreprise en termes de Qualité, d'Innovation et de Design, le tout allié à une sérieuse politique de protection de l'environnement.

## umweltzertifizierung

Die Einrichtung der Margres haben internationale Umweltzertifikate von hohem Ansehen erhalten. Überwachungsbehörden und Überwachungseinrichtungen haben offiziell die vollendeten Tätigkeiten des Unternehmens zur Wahrung der natürlichen Ressourcen des Planeten anerkannt. Diese Zertifikate bescheinigen die bewährten Umweltmethoden der Margres zum Schutz der nachhaltigen Entwicklung. Dies ist eine eindeutige Veranschaulichung der Möglichkeit, wie man Qualität, industrielle Innovation und Design mit einer ernsten Politik des Umweltschutzes abstimmen kann.

## a certificação ambiental

Os estabelecimentos da Margres obtiveram certificações ambientais internacionais de grande prestígio. Entidades e organismos de controlo reconheceram oficialmente o trabalho feito pela empresa para a salvaguarda dos recursos naturais do planeta. Esta certificação testemunha as boas práticas ambientais da Margres, na salvaguarda do desenvolvimento sustentável. Esta é uma demonstração concreta de como é possível conciliar Qualidade, Inovação Industrial e Design com uma séria política de salvaguarda do ambiente.

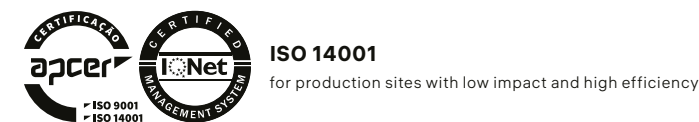

ISO 14001  
for production sites with low impact and high efficiency.



ISO 14001  
produit fabriqué sans négliger l'environnement



ISO 14001  
Produktherstellung unter Einbeziehung der Umwelt

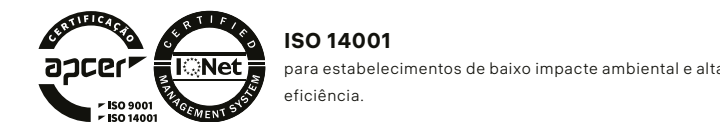

ISO 14001  
para estabelecimentos de baixo impacto ambiental e alta eficiência.

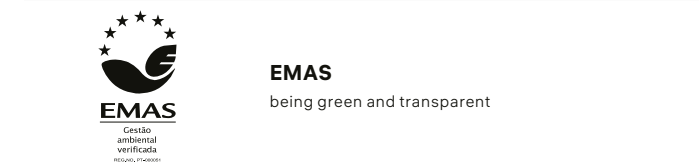

EMAS  
being green and transparent



EMAS  
pour être vert et transparent



EMAS  
grün und transparent

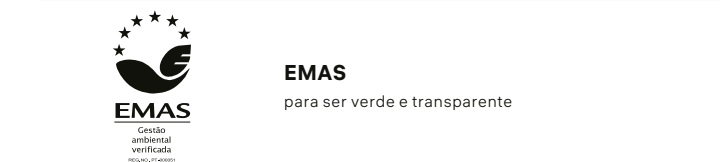

EMAS  
para ser verde e transparente

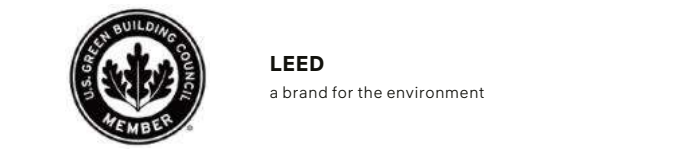

LEED  
a brand for the environment



LEED  
une marque pour l'environnement



LEED  
eine Marke für die Umwelt

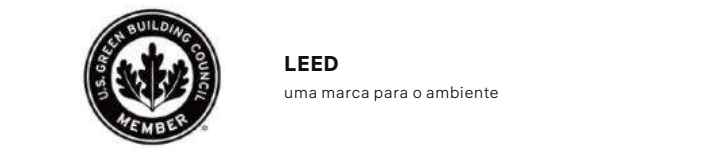

LEED  
uma marca para o ambiente

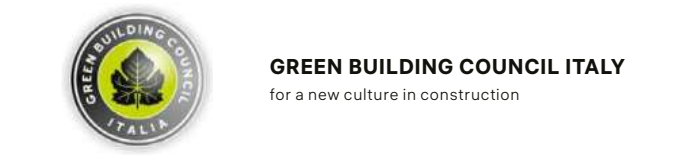

GREEN BUILDING COUNCIL ITALY  
for a new culture in construction



GREEN BUILDING COUNCIL ITALY  
pour une nouvelle culture de construction



GREEN BUILDING COUNCIL ITALY  
für einer neues Aufbaukultur



GREEN BUILDING COUNCIL ITALY  
para uma nova cultura de construção

index

colour map

collections

linea collections

useful information

calibers

certification

general sales conditions

important notes

magres green

laying suggestions

outdoor extra thick

package

pr()tect

symbols

technical information

think zero



# certification

certification . zertifizierung . certificação

EMAS



# certification

certification . zertifizierung . certificação

APCER



334

IQNET



335

general catalogue . 2023



index

colour map

collections

linea collections

useful information

calibers

certification

general sales

conditions

important notes

magres green

laying suggestions

outdoor extra thick

package

pr()tect

symbols

technical information

think zero



# certification

certification . zertifizierung . certificação



## CSTB

Centre Scientifique et Technique du Bâtiment

The quality of the Margres porcelain ceramic tile has been certified by the main institutions in the field, namely the Centre Scientifique et Technique du Bâtiment in France, benefiting from the prestige of the QB-UPEC brand mark and for CERTIF in Portugal.

La qualité du grès cérame de Margres a obtenu le certificat des principales institutions de la spécialité notamment du Centre Scientifique et Technique du Bâtiment en France, jouissant du prestige de produit de marque QB-UPEC et par CERTIF au Portugal.

Die Qualität des Feinsteinzeugs von Margres ist von den wichtigsten Institutionen dieses Fachbereichs zertifiziert, namentlich das Centre Scientifique et Technique du Bâtiment in Frankreich, das ihm die Klassifizierung QB-UPEC verlieh, und das CERTIF in Portugal.

A qualidade do Grês Porcelânico da Margres encontra-se certificada pelas principais instituições da especialidade, nomeadamente pelo Centre Scientifique et Technique du Bâtiment França, usufruindo deste o prestígio de produto de marca QB-UPEC e pela CERTIF em Portugal.



concept	P. 105	■	■	■
edge	P. 117	■	■	■
evoke	P. 071	■	■	■
extreme	P. 219	■	■	■
grove	P. 131	■	■	■
hybrid	P. 059	■	■	■
jungle	P. 083	■	■	■
natural	P. 187	■	■	■
prestige	P. 093	■	■	■
pure stone	P. 039	■	■	■
slabstone	P. 171	■	■	■
subway	P. 191	■	■	■
tecnic	P. 225	■	■	■
time 2.0	P. 201	■	■	■
tool	P. 145	■	■	■
underground	P. 159	■	■	■



pour plus d'informations, consultez <https://evaluation.cstb.fr>



for more information, consult <https://margres.com/en/company>  
 for plus d'informations, consultez <https://margres.com/fr/institutionnel>  
 Weitere Informationen finden Sie unter <https://margres.com/de/firma>  
 para mais informações, consulte <https://margres.com/pt/empresa>

## CERTIF



- index
- colour map
- collections
- linea collections
- useful information
- calibers
- certification
- general sales conditions
- important notes
- magres green
- laying suggestions
- outdoor extra thick
- package
- pr()tect
- symbols
- technical information
- think zero



**intended uses**

domaines d'emploi . verwendungszwecke . utilizações previstas

The characteristics of the product and the ease of installation, both with or without adhesive (dry installation on grass, gravel, or elevated floors), make the 20MM thick porcelain tile by Margres the best solution for external flooring of public and residential areas, such as urban spaces, pavements, garden paths, car parks, terraces, swimming pool edges, bathing facilities, parks and much more.  
The best solution to match external and internal spaces.

Les caractéristiques du produit ainsi que l'extrême facilité de pose aussi bien à sec (sur herbe, gravier, sols surélevés) qu'avec adhésif, font du grès cérame Margres épaisseur 20MM, la meilleure solution pour les pavages externes de zones publiques et résidentielles: places urbaines, trottoirs, voies piétonnes, parkings, terrasses, bords de piscine, établissements balnéaires, aménagement public paysager et bien d'autres domaines encore.  
Une solution optimale pour obtenir un ensemble parfaitement coordonné entre intérieur et extérieur.

Die Produkteigenschaften und extreme Einfachheit sowohl der Trockenverlegung (auf Gras, Kies, als Doppelboden) als auch der Klebverlegung, machen das Feinsteinzeug von Margres mit 20MM Stärke zur besten Lösung bei Bodenbelägen im Außenbereich von öffentlichen und privaten Anlagen: Stadtplätze, Bürgersteige, Wege, Parkplätze, Terrassen, Poolumrandungen, Badeanlagen, öffentliche Grünanlagen und vieles mehr.  
Die beste Lösung um eine optimale Koordination zwischen Innen- und Außenbereich zu erhalten.

As características técnicas bem como a facilidade de instalação, com ou sem colas (instalação a seco em relva, gralilha ou pavimentos sobrelevados), fazem das placas cerâmicas Margres 20MM a melhor solução para a pavimentação de espaços exteriores sejam eles públicos ou privados, tais como jardins, garagens, caminhos pedonais, terraços, piscinas, áreas urbanas, etc.  
Trata-se igualmente de uma boa solução para combinar espaços interiores e exteriores.



**instructions for matching sizes and pedestals in elevated floor installation**

instruction pour le couplage des formats et supports lors de la pose surélevée  
anweisungen für die verbindung von formaten und auflagen bei der verlegung von doppelböden  
instruções de combinação de tamanhos e suportes na aplicação sobreelevada

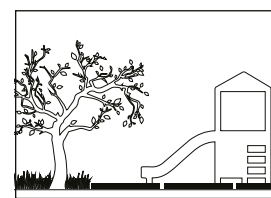
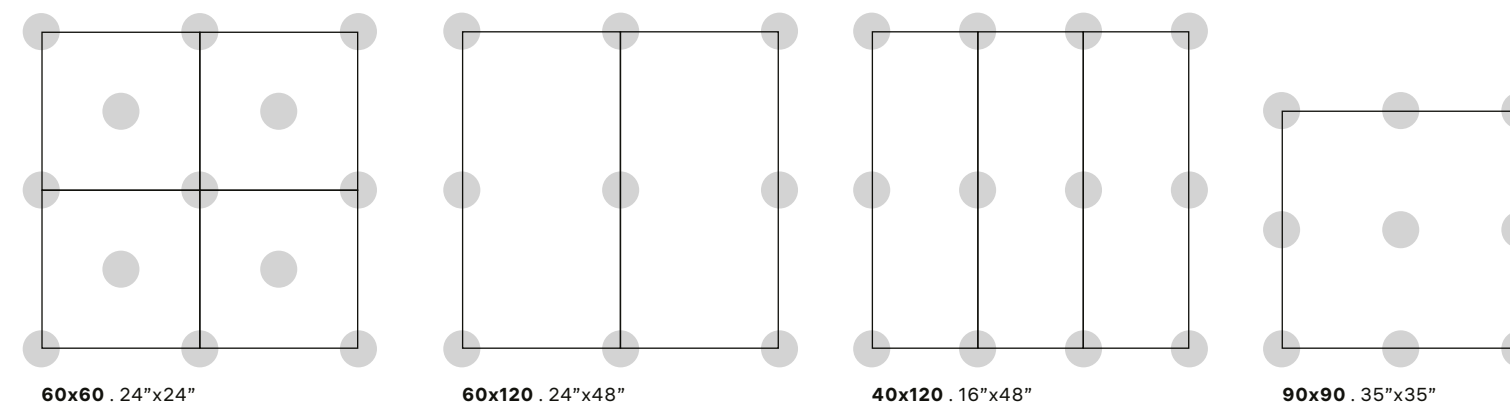

gardens and public areas  
jardins et espaces publics  
gärten und öffentliche anlagen  
jardins e espaços públicos

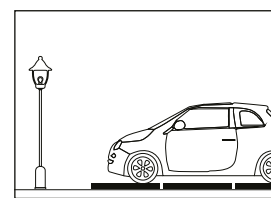

parking lots  
parkings  
parkplätze  
parques de estacionamento

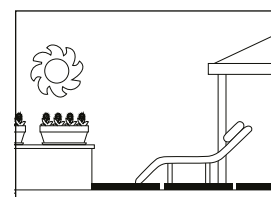

terraces  
terrasses  
terrassen  
terraços

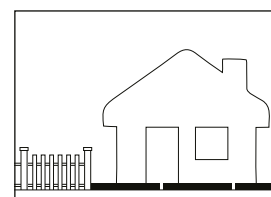

sidewalks and pedestrian areas  
chaussées, zones piétonnes  
bürgersteige, zugänge und andere fußgängerzonen  
calçadas, acessos e zonas pedonais

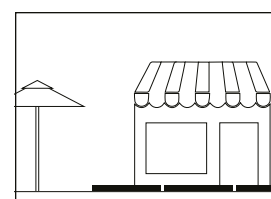

seaside resorts  
complexes balnéaires  
badekomplexe und seebäder  
complexos e estâncias balneares

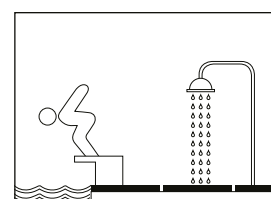

pool surrounding areas  
contours de piscines  
bereiche in der umgebung von schwimmbecken  
envolventes de piscina

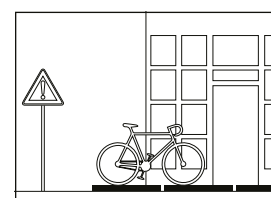

urban areas  
zones urbaines  
städtische gebiete  
áreas urbanas

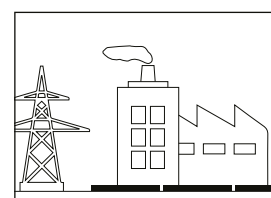

industrial areas  
zones industrielles  
industriegebiete  
zonas industriais



**special pieces**

pièces spéciales . spezialteile . peças especiais

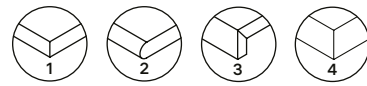

	straight edge margelle stufenplatte base <b>30x60 E ASR</b> 12"x24"	bullnose margelle arrondie stufenplatte abgerundet base boleada <b>30x60 E ASR</b> 12"x24"	step extra thick 20mm nez de marche forte épaisseur 20mm massive stufenplatte 20mm degrau espessurado 20mm <b>30x60 E ASR</b> 12"x24"	<b>30x90 E ASR</b> 12"x36"	<b>30x120 E ASR</b> 12"x48"	step extra thick 20mm corner* nez de marche forte épaisseur 20mm angle* ecke massive stufenplatte 20mm* degrau espessurado 20mm canto* <b>30x60 E ASR</b> 12"x24"	<b>30x90 E ASR</b> 12"x36"	<b>30x120 E ASR</b> 12"x48"
<b>evoke</b>	■ MP-6490	■ MP-6500	■ MP-6590	■ MP-6640	■ MP-6685	■ MP-6680	■ MP-6700	■ MP-6740
<b>grove</b>	■ MP-6490	■ MP-6500	■ MP-6590		■ MP-6685	■ MP-6680		■ MP-6740
<b>jungle</b>	■ MP-6490	■ MP-6500	■ MP-6590		■ MP-6685	■ MP-6680		■ MP-6740
<b>pure stone</b>	■ MP-6490	■ MP-6500	■ MP-6590		■ MP-6685	■ MP-6680		■ MP-6740
<b>slabstone</b>	■ MP-6490	■ MP-6500	■ MP-6590			■ MP-6680		
<b>subway</b>	■ MP-6490	■ MP-6500	■ MP-6590			■ MP-6680		
<b>tool</b>	■ MP-6490	■ MP-6500	■ MP-6590			■ MP-6680		

**step extra thick 20mm**  
nez de marche forte épaisseur 20mm  
ecke massive stufenplatte 20mm  
degrau espessurado 20mm

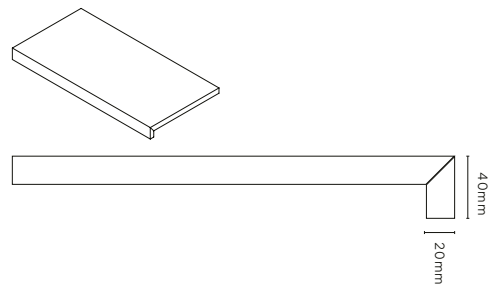

**step extra thick 20mm corner**  
nez de marche forte épaisseur 20mm angle  
ecke massive stufenplatte 20mm  
degrau espessurado 20mm canto

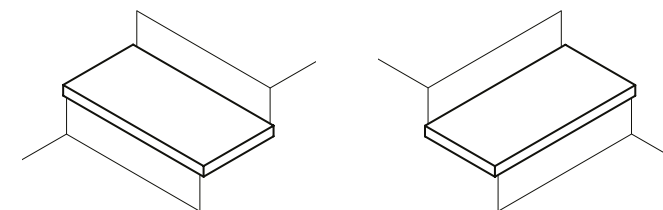

right corner . angle droit  
rechten ecke . canto direito

left corner . angle gauche  
links ecke . canto esquerdo

\*Available in right and left corner  
\*Disponible dans les coin droit et gauche  
\*Erhältlich in der rechten Ecke und links  
\*Disponível no canto direito e esquerdo

**swimming pool edges**

margelles de piscine . beckenrandsteine . bordos de piscina

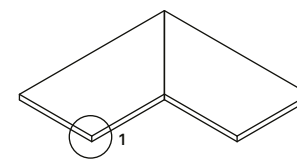
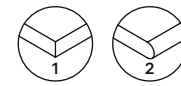

straight edge inner corner  
margelle angle bord droit intérieur  
eckstufe  
canto interior  
**30x60 . 12"x24"**

**E ASR** MP-6620

(sold per two pieces set . vendu à la paire  
paarweise verkauft . vendida ao par)

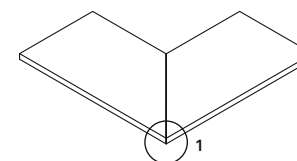

straight edge outer corner  
margelle angle bord droit extérieur  
eckstufe außenseite  
canto exterior  
**30x60 . 12"x24"**

**E ASR** MP-6620

(sold per two pieces set . vendu à la paire  
paarweise verkauft . vendida ao par)

**overflow grille 20MM OVER**  
grille 20MM  
überlauf überlauf 20MM  
grelha 20MM

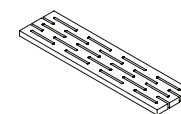

Available in all 20mm thickness ranges.  
Disponible dans toutes les collections avec épaisseur 20mm.  
Verfügbar in allen 20mm Stärke Serien.  
Disponível em todas as coleções com espessura 20mm.

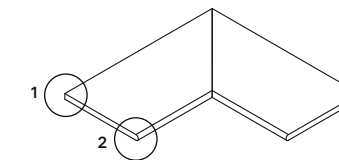

bullnose inner corner  
margelle bord intérieur arrondi  
abgerundete innenecke (gärung)  
canto interior boleado  
**30x60 . 12"x24"**

**E ASR** MP-6650

(sold per two pieces set . vendu à la paire  
paarweise verkauft . vendida ao par)

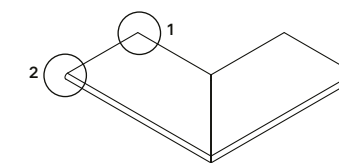

bullnose outer corner  
margelle bord extérieur arrondi  
abgerundete aussenecke (gärung)  
canto exterior boleado  
**30x60 . 12"x24"**

**E ASR** MP-6650

(sold per two pieces set . vendu à la paire  
paarweise verkauft . vendida ao par)

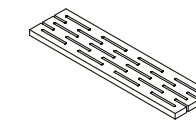

overflow grille MG  
grille MG  
überlauf MG  
grelha MG  
**15x60 . 6"x24"**  
**E ASR** MP-6520

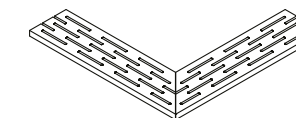

overflow corner grille MG  
angle grille MG  
überlauf ecke MG  
canto grelha MG  
**15x60 . 6"x24"**  
**E ASR** MP-6700

(sold per two pieces set . vendu à la paire  
paarweise verkauft . vendida ao par)

**useful information**

calibers

certification

general sales  
conditions

important notes

magres green

laying suggestions

**outdoor extra thick**

package

pr()tect

symbols

technical information

think zero



# technical information

— information technique . technische information . informação técnica

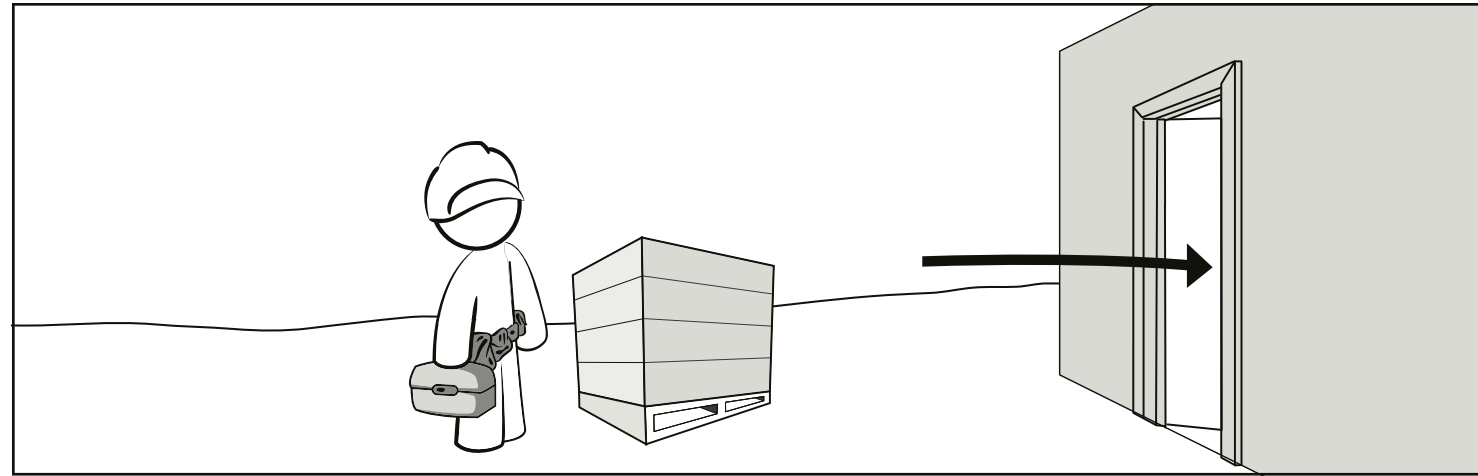

Before (beginning the) laying (of) ceramic material, you should take the following aspects into account:

- Check if the ceramic material is suitable for (use at) the selected site, according to its specifications and technical characteristics;
- Check whether there is enough material to conclude the work;
- Check the boxes to see/confirm in the boxes if the product is in the same shade, choice and caliber;
- Claims regarding these items cannot be accepted after tile setting.

The good performance of the ceramic material depends strongly on the conditions of application for which it is extremely important to ensure the following assumptions:

Avant de commencer la pose du matériau céramique, les aspects suivants devront être pris en considération:

- Vérifier si le matériau céramique est indiqué pour une utilisation dans le lieu choisi, conformément à ses spécifications et caractéristiques techniques;
- Vérifier s'il existe la quantité de matériau suffisante pour réaliser le chantier;
- Confirmer dans les boîtes si le produit est du même ton, de la même qualité, et du même calibre;
- Les réclamations relatives au matériel déjà posé ne pourront pas être acceptées.

La bonne performance du matériau céramique dépend fortement des conditions d'application. Il est donc extrêmement important de garantir les conditions préalables suivantes:

Vor dem Beginn der Verlegearbeiten sollten Sie folgende Punkte berücksichtigen:

- Bitte überprüfen Sie, ob die gewählte Fliese laut ihrer Oberflächenbeschaffenheit und ihren technischen Eigenschaften geeignet für das Einsatzgebiet ist;
- Bitte prüfen Sie nach, ob die Menge der gewählten Fliese ausreicht, um das geplante Bauprojekt fertig zu stellen;
- Bitte prüfen Sie, ob die Fliesen aus verschiedenen Kartons dieselbe Beschaffenheit, (Ton, Wahl und Kaliber) haben;
- Diesbezügliche Beanstandungen können nach der Verlegung nicht berücksichtigt werden.

Die Leistungsfähigkeit der Fliese hängt stark davon ab, wie die Fliesen verlegt werden. Daher ist es sehr wichtig, die folgenden Punkte zu beachten:

Antes de iniciar o assentamento do material cerâmico, deverá ter em consideração os seguintes aspetos:

- Verificar se o material cerâmico é indicado para utilizar no local selecionado de acordo com as suas especificações e características técnicas;
- Verificar se existe material suficiente para realizar a obra;
- Confirmar nas caixas se o produto é da mesma tonalidade/lote, escolha e calibre;
- Não se aceitam reclamações relativas a materiais já aplicados.

O bom desempenho do material cerâmico depende fortemente das condições de aplicação pelo que é de extrema importância garantir os seguintes pressupostos:

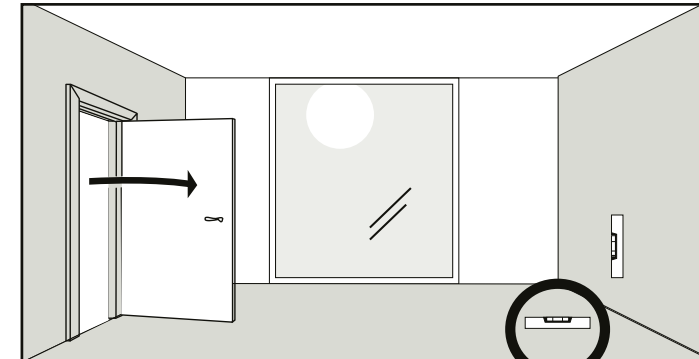

## 01

### support

The support must be stable, free of debris, dust and cracks. Curing times and stability of the treatments to which the support may have been subjected should be respected.

You should check its flatness and stabilize it, if necessary with the help of products suitable for the purpose.

These aspects are vital for wall and floor ceramic tiles.

### le support

Le support doit être stable, exempt de résidus, fentes et poussières. Les temps de durcissement et de stabilité des traitements auxquels il doit être soumis devront être respectés.

La planéité du support doit être vérifiée et le nivellement doit être réalisé si cela est nécessaire, à l'aide de produits appropriés.

Ces aspects sont essentiels pour les revêtements de sol et muraux céramiques.

### der untergrund

Der Untergrund muss stabil, sauber, sowie frei von Rissen und Staub sein. Sollte der Untergrund vor dem Verlegen der Fliesen speziell behandelt werden müssen, so sollten Sie darauf achten, dass die Behandlung gut gelungen und abgeschlossen ist, bevor Sie die Fliesen verlegen.

Sie sollten den Untergrund inspizieren. Falls er nicht eben ist, muss er mit Hilfe von passenden Produkten grundiert werden.

Diese Vorsicht ist angebracht und eine unabdingbare Voraussetzung für das fachgerechte Verlegen von Boden- und Wandfliesen.

### o suporte

O suporte deve apresentar-se estável, limpo de resíduos, fendas e poeiras. Deverão ser respeitados os tempos de cura e estabilidade dos tratamentos a que possa ter sido sujeito.

Deve fazer-se a verificação da planaridade do mesmo, procedendo à regularização, se necessário com a ajuda de produtos adequados a esse fim.

Estes aspetos são vitais para pavimentos e revestimentos cerâmicos.

# technical information

information technique . technische information . informação técnica

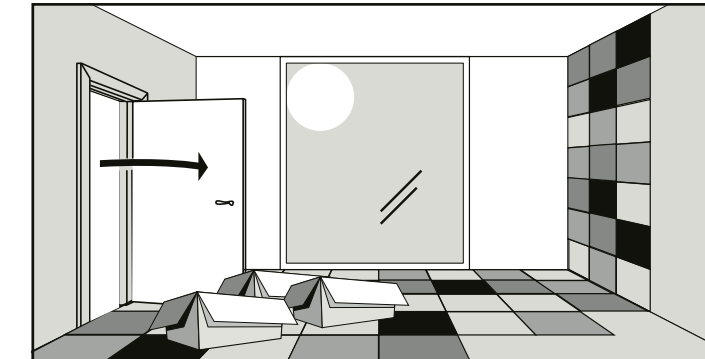

## 02

### material

For a better visual effect of the product, it is advisable to use alternating ceramic pieces taken from various packages simultaneously.

If the product has shade variations or has different graphics and shades, it should be applied randomly.

### le matériau

Pour obtenir un meilleur effet visuel avec le produit, il est conseillé d'utiliser de forme alternée des pièces céramiques retirées simultanément de plusieurs emballages.

Si le produit est dénuancé ou a un aspect graphique différent et une tonalité différente, il devra être appliqué de forme aléatoire.

### das material

Damit Sie das beste Ergebnis erzielen, ist es ratsam, die Fliesen immer aus verschiedenen Paketen zu wählen und in regelmäßig abwechselnder Folge zu verlegen.

Falls das Produkt diverse Farbschattierung, einen unterschiedliche Farbton oder grafisches Design aufweist, müssen die Fliesen auf diese Weise verlegt werden.

### o material

Para obter um melhor efeito visual do produto, aconselha-se a utilização, alternada, de peças cerâmicas retiradas de várias embalagens em simultâneo.

Caso o produto seja destonalizado ou tenha gráfica e tonalidade diferente, deverá ser aplicado de forma aleatória.

index

colour map

collections

linea collections

useful information

calibers

certification

general sales conditions

important notes

magres green

laying suggestions

outdoor extra thick

package

pr()tect

symbols

technical information

think zero



# technical information

information technique . technische information . informação técnica

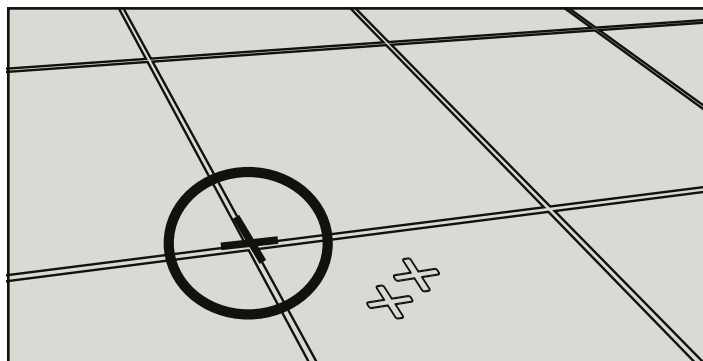

≥ 2mm    ≥ 3mm

## 03

### joints for tile-laying

For a perfect application of the ceramic pieces, you should definitely use joints. They fulfill important aesthetic and technical functions, facilitating alignment of the materials, absorbing any possible deformation liable to be felt in the structure - floor and wall - thus preventing the transmission of deformations to the ceramic pieces.

We advise the use of leveling systems when applying big ceramic formats material.

Use the minimum recommended joints so as to ensure a good aesthetic aspect of the ceramic pieces, and respect the rules of application as follows.

NOTE: Regardless of the values presented here, the person applying it should always follow the regulations of the countries where he is doing this application work.

### joints de pose

L'utilisation de joints de pose est obligatoire afin d'obtenir une pose parfaite des pièces céramiques,. Ils remplissent une importante fonction esthétique et technique. Ils facilitent l'alignement des matériaux et absorbent d'éventuelles déformations qui peuvent se produire dans la structure – sols et murs – et empêchent donc la transmission de ces déformations aux pièces céramiques. Nous recommandons l'utilisation de niveleurs lors de l'application de matériaux de grand format

Utiliser Les joints minimaux recommandés afin de garantir un bon aspect esthétique des pièces céramiques et respecter les normes d'application sont les suivants.

REMARQUE: Indépendamment des valeurs ici présentées, l'applicateur devra toujours suivre les réglementations du pays où il réalise ce travail d'application.

### das verfugen

Um die keramischen Platten perfekt zu verlegen, sollten Sie die Wand oder den Boden ordnungsgemäß verfugen. Die Fugen haben wichtige ästhetische und technische Funktionen. Sie erleichtern das Aufreihen der Fliesen; sie absorbieren eventuelle Verformungen der Wand oder des Bodens, und vermeiden dadurch die Übertragung dieser Verformungen auf die Fliesen.

Wir empfehlen die Benutzung von selbstnivellierenden Abstandhaltern, wenn es darum geht, Fliesen von grösseren Formaten zu verlegen, wie zum Beispiel Die empfohlenen Fugenbreiten, welche eine schöne Optik sowie eine regelgerechte Verlegung gewährleisten, sind nachfolgend angegeben.

WICHTIG: Abgesehen von den oben angegebenen Fugenbreiten, muss der Fliesenleger immer den jeweils geltenden landesspezifischen Vorschriften Folge leisten.

### juntas de assentamento

Tendo em vista uma perfeita aplicação das peças cerâmicas, deve usar-se obrigatoriamente juntas de assentamento. Estas cumprem importantes funções estéticas e técnicas, facilitando o alinhamento dos materiais, absorvendo eventuais deformações que se possam fazer sentir na estrutura – chão e parede – e impedindo, assim, a transmissão destas deformações às peças cerâmicas.

Aconselhamos a utilização de niveladores aquando da aplicação de material de grandes formatos.

Utilizar as juntas mínimas recomendadas de forma a garantir um bom aspeto estético das peças cerâmicas, bem como respeitar as normas de aplicação.

NOTA: independentemente dos valores aqui apresentados, o aplicador deverá sempre seguir as normativas dos países onde está a fazer este trabalho de aplicação.

	application . pose . anwendung . aplicação		
finishing finition fertigung acabamento	indoor intérieur innen interior	outdoor extérieur außen exterior	raised floor dalles sur plot doppelboden sobreelevado
non rectifié non rectifié presskante não retificado	3mm	4mm *	-
rectified rectifié rektifiziert retificado	2mm	3mm *	-
20mm rectified 20mm rectifié 20mm rektifiziert 20mm retificado	2mm	3mm *	3mm

\* it's recommended to increase in 2mm the minimum joint in the darker colours. For further information please go to our website and read product's technical data sheet.

\* pour les couleurs foncées il est recommandé de rajouter 2mm au joint minimum. Consultez la fiche technique du produit respectif sur le site web.

\* Bei dunklen Farben wird empfohlen, 2 mm zur Mindestfuge noch weiter hinzuzufügen. Konsultieren Sie das technische Datenblatt des Produkts auf der Website.

\* para as cores escuras recomenda-se acrescentar 2mm à junta mínima. Consultar a ficha técnica do respetivo produto no site.

**MARGRES**  
CERAMIC TILES

# technical information

information technique . technische information . informação técnica

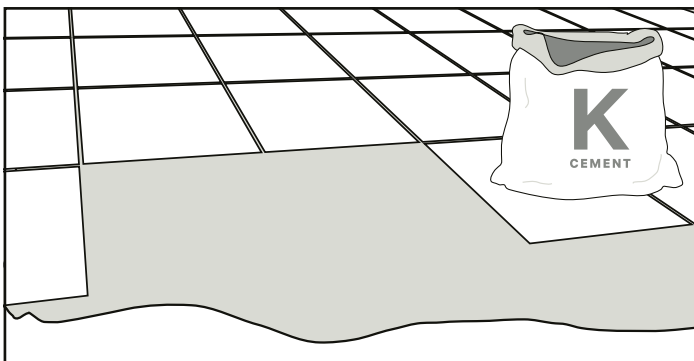

## 04

### glue and mortar

The mortars, grouting mortars, glue-cements, and glues to be used should take into account both the support and the intended purpose of the ceramic pieces - indoor, outdoor, wall, floor - and their typology – Porcelain stoneware.

You should follow the instructions provided by the manufacturer on its use.

### colle et mortiers

Les mortiers, mortiers de rejointoiment, ciments-colles et colles à utiliser devront tenir compte du support et de la fin à laquelle sont destinées les pièces céramiques - intérieur, extérieur, mur, plancher - ainsi que de leur typologie - Grès cérame.

Vous devrez suivre les instructions indiquées par le fabricant pour son utilisation.

### kleber und mörtel

Welchen Mörtel, welchen Zementkleber oder welche andere Verbundmittel Sie am besten verwenden, hängt sowohl vom Untergrund als auch vom Material (Monoporosa, glasierte Fliesen) ab. Es kommt ebenso darauf an, ob die Fliesen im Außen- Feinsteinzeug.

Bitte befolgen Sie die Herstellerangaben zum Gebrauch des Produktes.

### cola e argamassas

As argamassas, argamassas de rejuntamento, cimentos-colas e colas a utilizar deverão ter em conta o suporte e o fim a que se destinam as peças cerâmicas - interior, exterior, parede, pavimento - e a sua tipologia - Grés porcelânico. Deverá seguir as instruções indicadas pelo fabricante sobre a sua utilização.

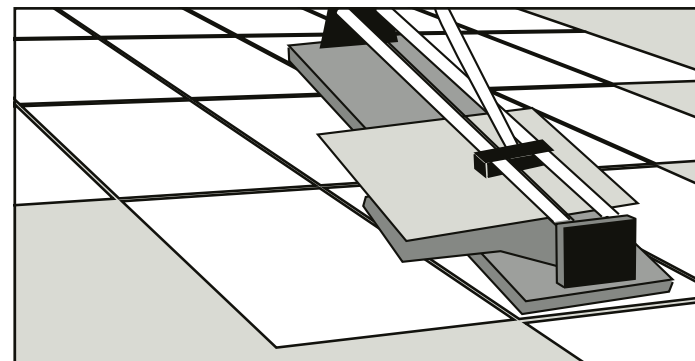

## 05

### cutting instructions

We recommend wet cutting or the score and snap method during the installation process.

Do not dry cut using power tools during the installation process.

Improper installation techniques could expose installer to harmful silica dust.

### instructions de découpe

Nous recommandons la découpe avec refroidissement d'eau ou usage d'un découpant manuel avec méthode de marquage et decoupage pendant la pose.

Ne pas utiliser d'outils électriques ou de decoupage à sec pendant la pose.

Des techniques de pose inadéquates pourront exposer le poseur à des poussières de silice et nuire à la santé.

### schneideempfehlung

Wir empfehlen das Nassschneiden oder die Ritz- und Brechmethode während des Installationsprozesses.

Während des Installationsvorgangs nicht mit Elektrowerkzeugen trocken schneiden.

Durch unsachgemäße Installationstechniken kann der Installateur schädlichem Quarzstaub ausgesetzt werden.

### instruções de corte

Recomendamos o corte com arrefecimento de água ou utilização de cortador manual com método de marcação e corte durante o processo de instalação. Não usar ferramentas elétricas com corte a seco durante o processo de instalação.

Técnicas de instalação impróprias poderão expor o instalador à poeira de sílica de forma prejudicial.

index

colour map

collections

linea collections

useful information

calibers

certification

general sales conditions

important notes

magres green

laying suggestions

outdoor extra thick

package

pr()tect

symbols

technical information

think zero



# technical information

— information technique . technische information . informação técnica

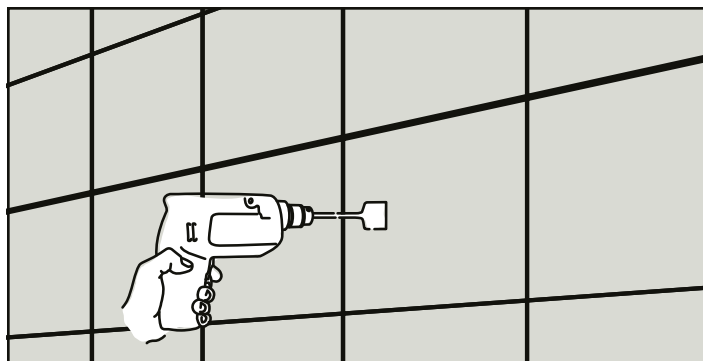

## 06

### holes

For drilling you should use diamond twist drills with a diameter adaptable to the desired hole.

### perçages

Pour le perçage, utiliser des trépan diamantés avec un diamètre adapté au trou désiré.

### löcher

Löcher sollten im gewünschten Durchmesser mittels einer Diamanthammerbohrkrone in die Fliese gebohrt werden.

### furos

Na furação deverão ser utilizadas brocas cranianas diamantadas com diâmetro adaptável ao furo pretendido.

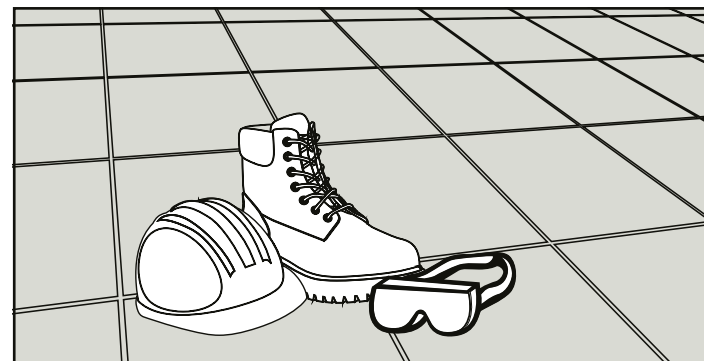

## 07

### safety and preparation for laying the material

We advise the use of appropriate PPE (personal protective equipment), namely safety footwear, protective gloves and even goggles (safety glasses) and hearing protection in operations of cutting material.

Good practices must be followed in terms of lifting and carrying loads.

### sécurité lors de la préparation et de la pose du matériau

Il est conseillé d'utiliser un EPI (équipement de protection individuelle) approprié, notamment des chaussures de sécurité, des gants de protection, mais aussi des lunettes et une protection auditive lors des opérations de coupe du matériau.

Respectez les bonnes pratiques concernant le levage et le transport manuel de charges devront être appliquées.

### sicherheitshinweise für das verlegen von fliesen

Wir empfehlen Ihnen, immer die passende Schutzkleidung zu tragen. Wir ermahnen Sie eindringlich, Schutzschuhe, -handschuhe, -brille sowie Gehörschutz zu benutzen, wenn Sie die Fliesen zuschneiden.

Achten Sie bitte auf die richtige Körperhaltung, wenn Sie Lasten heben und tragen.

### segurança na preparação e assentamento do material

Aconselha-se a utilização de EPI (equipamento de proteção individual) adequado, nomeadamente, calçado de segurança, luvas de proteção e ainda óculos e proteção auditiva nas operações de corte do material.

Devem ser cumpridas as boas práticas a nível do levantamento e transporte manual de cargas.

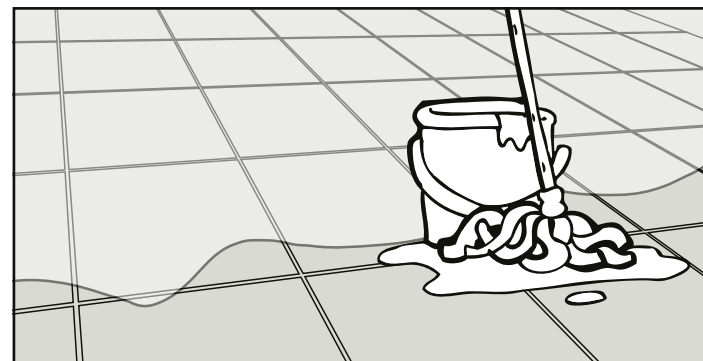

## 08

### protection and cleaning

All residues of glue and grout mortar should be cleaned from the surface of the parts immediately after application and in accordance with the manufacturer's instructions.

Immediately after the laying of ceramic material it is recommended that the ceramic parts are / will be duly protected. For dirt removal after the work, such as left-over joints, cements, etc., it is recommended that you use a buffered descaling acid to remove all residues.

In daily maintenance, ordinary detergents may be used, respecting the dilutions recommended by the respective manufacturer.

Regarding decorated pieces, you should avoid the use of abrasive cleansers that may damage the pieces.

Pieces decorated through the depositing of titanium particles - Gold and Silver - which give them a metallic aspect should be handled with care. The final cleaning and maintenance of this type of product should be made with detergents suitable for metals - stainless steel brightener - so as to create an antistatic effect that can repel dirt and protect the product from fats and corrosion.

Regular cleaning of the product should be done with a damp cloth moisturized with water or window cleaner, and after it gets dry, a dry cloth shall be used.

### protection et nettoyage

Tous les résidus de colle et de mortier de jointoiment doivent être nettoyés de la surface des pièces immédiatement après l'application et conformément aux instructions du fabricant.

Immédiatement après la pose du matériau céramique, il est recommandé de protéger correctement les pièces céramiques. Pour l'élimination de la saleté résultant des travaux, comme les résidus de joints, ciments, etc., il est recommandé d'utiliser un acide tamponné désincrustant.

L'entretien quotidien pourra être réalisé avec des détergents ordinaires, en respectant les dilutions recommandées par le fabricant respectif.

Pour les pièces décorées, l'utilisation de produits de nettoyage abrasifs devra être évitée car ils pourront endommager les pièces.

Les pièces décorées grâce au dépôt de particules de titane - Gold et Silver - qui lui confèrent un aspect métallique, devront être manipulées avec soin. Le nettoyage final et d'entretien de ce type de produit devra être réalisé avec des détergents spécifiques pour les métaux - agent de brillantage d'acier inox - afin de créer un effet antistatique qui puisse repousser la saleté et protéger le produit des graisses et de la corrosion.

Le nettoyage régulier du produit doit être effectué avec un chiffon imbibé d'eau ou de nettoyant pour vitres et, après séchage, on doit passer un chiffon sec.

# technical information

information technique . technische information . informação técnica —

## schutz und reinigung

Alle Rückstände von Klebstoff und Fugenmörtel sollten von der Oberfläche der Stücke unmittelbar nach dem Auftragen und in Übereinstimmung mit den Anweisungen des Herstellers gereinigt werden.

Bitte vergessen Sie nicht sofort nach Beendigung der Verlegearbeiten, die verfliese Fläche ordnungsgemäß zu schützen. Waschen Sie die verfliese Fläche mit Säure um etwaigen Schmutz (wie z.B.: Schlieren vom Fugenmaterial, Zement, etc.) zu beseitigen.

Für die alltägliche Pflege empfehlen wir die Verwendung von handelsüblichen Reinigungsmitteln. Beachten Sie bitte die Verdünnungsanweisung des Herstellers des Produktes.

Die Pflege und die Reinigung der keramischen Platten ist sehr einfach und sollte mit neutralen Putzmitteln durchgeführt werden.

Bitte befolgen Sie die Herstellerangaben zum Gebrauch des Produktes. Schleifmittel können zur Beschädigung der Dekore führen und sind daher zu vermeiden.

Gold und Silver Stücke die durch die Ablagerung von Titanpartikeln - die ihnen einen metallischen Aspekt geben, verziert sind, sollten mit Vorsicht behandelt werden. Die Endreinigung und Wartung dieses Produkttyps sollte mit für Metalle geeigneten Reinigungsmitteln - Aufheller aus rostfreiem Stahl - durchgeführt werden, um eine antistatische Wirkung zu erzielen, die Schmutz abweisen und das Produkt vor Fetten und Korrosion schützen kann.

Die regelmäßige Reinigung des Produkts sollte mit einem mit Wasser oder Glasreiniger angefeuchteten Tuch erfolgen. Nach dem Trocknen sollte man die Flächen mit einem trockenen Tuch abwischen.

## proteção e limpeza

Todos os resíduos de cola e argamassa de rejuntamento devem ser limpos da superfície das peças, imediatamente após a sua aplicação e de acordo com as instruções do fabricante.

Imediatamente após o assentamento do material cerâmico recomenda-se que as peças cerâmicas sejam devidamente protegidas. Para remoção de sujidade pós-obra, tais como resto de junta, cimentos, etc, recomenda-se a utilização de um ácido desincrustante tamponado para remoção de todos os resíduos.

Na manutenção diária poderão ser utilizados detergentes comuns, respeitando as diluições recomendadas pelo respetivo fabricante.

Relativamente às peças decoradas, dever-se-á evitar a utilização de produtos de limpeza abrasivos, que poderão danificar as peças.

As peças decoradas através da deposição de partículas de titânio - acabamento gold e silver - que lhe conferem um aspeto metálico deverão ser manuseadas com cuidado. A limpeza final e de manutenção deste tipo de produto deverá ser feita com detergentes próprios para metais - abrilhantador de aço inox - de forma a criar um efeito antiestático que possa repelir a sujidade e proteger o produto de gorduras e corrosão.

A limpeza regular do produto deverá ser feita com um pano humedecido em água ou limpa-vidros e após secagem deverá ser passado um pano seco.

index

colour map

collections

linea collections

useful information

calibers

certification

general sales conditions

important notes

magres green

laying suggestions

outdoor extra thick

package

pr()tect

symbols

technical information

think zero



# technical information

information technique . technische information . informação técnica

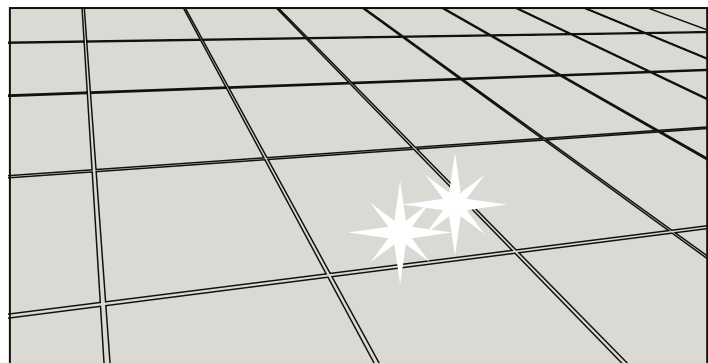

09

## polished and soft shiny products

The parts of POLISHED and SOFT SHINY finishes series require specialized application and maintenance treatment.

The POLISHED and SOFT SHINY finishes are recommended, as well as for wall cladding, also for flooring in residential or light commercial areas that are not subjected to heavy traffic, where anti-slip characteristics are not required. The occasional presence of small inconsistencies or little spots on the surface is to be considered a characteristic of the material and of its unique production process. If the product is laid in direct contact with external environments, it is recommended to use protective solutions to reduce the formation of scratches.

### Glue and Mortar

Preferably use mortars for grouting of color identical to the color of the product, and according to its specification - stoneware.

### Application

In its application, you should take utmost care in removing the mortars used for grouting. Cleaning must be carried out with a wet cloth or sponge while the joint mortars are still wet, and avoid the use of abrasive detergents that could damage the parts.

### Protection and Cleaning

The final cleaning and maintenance of the product should be done with suitable detergents for floorings.

Diluted highly concentrated detergent should be used in accordance with the supplier's instructions and, depending on the degree of dirt, dilution of the detergent may be greatly reduced and in some cases may reach the proportion of 1/3 (detergent / water).

Scrub with a micro-fiber cleaning cloth.

If the product is heavily soiled, we advise you to clean it manually.

In very exceptional cases of non-removal of dirt with the above presented method, we recommend the use of a white polymer foam (1) used only with water.

(1) Commercially known as magic sponge.

## produits polis et adoucis

Les pièces des séries à finition POLI et ADOUCI nécessitent un traitement d'application et d'entretien spécialisé.

En plus des revêtements, la finition POLI et ADOUCI est également recommandée pour les sols dans les environnements résidentiels ou commerciaux légers peu soumis à des contraintes élevées, pour lesquels aucune prestation antidérapante n'est requise. La présence sporadique de petites irrégularités ou de points à la surface doit être considérée comme une caractéristique du matériau et de sa fabrication particulière. Si le produit est placé en contact direct avec l'extérieur, il est conseillé d'utiliser des solutions de protection afin d'éviter la formation de

rayures. Dans les zones à passage de charges lourdes concentrées, l'utilisation de produits d'épaisseur réduite n'est pas recommandée.

### Colle et mortier

Utilisez des mortiers pour le jointoiment, de préférence de couleur identique à celle du produit, et selon les spécifications du produit - grès.

### Application

Lors de l'application, vous devez faire très attention à l'enlèvement des mortiers utilisés pour le jointement. Le nettoyage doit être effectué avec un chiffon humide ou une éponge, alors que les mortiers des joints sont encore humides, et on doit éviter l'utilisation de détergents abrasifs qui pourraient endommager les pièces.

### Protection et nettoyage

Le nettoyage final et l'entretien du produit doivent être effectués avec des détergents appropriés pour les revêtements de sol.

On doit utiliser un détergent hautement concentré, dilué conformément aux instructions du fournisseur. En fonction du degré de salissure, la dilution du détergent pourra être peut être considérablement réduite et dans certains cas, elle peut atteindre la proportion de 1/3 (détergent/eau).

Frotter avec un chiffon de nettoyage en microfibre.

Si le produit est très sale, nous vous conseillons de le nettoyer à la main.

Dans les cas très exceptionnels de non-élimination de la saleté avec la méthode présentée ci-dessus, nous recommandons l'utilisation d'une mousse polymère blanche (1) utilisée uniquement avec de l'eau.

(1) Commercialement appelée éponge magique.

## polierte und halbpoliert produkte

Die Serien Reihen mit POLIERTER und HALB POLIERTER Fertigstellung erfordern eine spezielle Anwendung und Wartung.

Die POLIERTEN und HALBPOLIERTEN Oberflächen werden nicht nur für Wandverkleidungen empfohlen, sondern auch für Böden in Wohn- bzw. Gewerbebereichen, die keiner hohen Belastung ausgesetzt sind und bei denen keine rutschhemmende Wirkung erforderlich ist. Das sporadische Vorhandensein von kleinen Unebenheiten oder Punkten auf der Oberfläche ist als ein Merkmal von Material und besonderer Verarbeitung zu betrachten. Wird das Produkt in direkten Kontakt mit der Außenseite gebracht, wird empfohlen, Schutzlösungen zu verwenden, um die Bildung von Kratzern zu vermeiden. In Bereichen, die schwerer Belastung ausgesetzt sind, ist die Verwendung von Produkten mit reduzierter Stärke nicht empfehlenswert.

### Klebstoff und Mörtel

Verwenden Sie Betumenmasse, vorzugsweise mit einer Farbe, die mit der Farbe des Produkts identisch ist, und gemäß der Produktspezifikation - Steinzeug.

### Anwendung und erste Reinigung

Sie sollten beim Entfernen des zur Ausfugung verwendeten Mörtels vorsichtig vorgehen. Die Reinigung sollte durchgeführt werden, solange der Fugenmörtel noch feucht ist. Verwenden Sie dazu ein feuchtes Tuch oder einen Schwamm und vermeiden Sie kratzenden oder scheuernden Mittel, die die Teile beschädigen könnten.

Wenn die Teile einen trockenen Überschuss an Abdichtung aufweisen, entfernen Sie sie am besten mit einem sauberen, trockenen Papiertuch oder einem Stofftuch. Diese Reinigung kann entweder manuell oder mit einem geeigneten Spatel erfolgen.

Wir empfehlen, bei dieser Reinigung keine Schleifmittel oder kontaminierenden Materialien zu verwenden.

Wenn für die Reinigung flüssige Produkte verwendet werden, kann dies dazu führen, dass die gewünschte Wirksamkeit der abweisenden und schützenden Behandlung mit der wasserfesten Anwendung verringert wird.

### Wartung

Die finale Reinigung und Pflege des Produkts muss mit für Fußböden geeigneten Reinigungsmitteln erfolgen.

Es sollte ein hochkonzentriertes Reinigungsmittel verwendet werden, das gemäß den Anweisungen des Lieferanten verdünnt werden soll. Je nach Verschmutzungsgrad muss die Verdünnung des Waschmittels möglicherweise erheblich reduziert werden, in einigen Fällen mit einem Anteil von 1/3 (Reinigungsmittel / Wasser).

Mit einem Mikrofaser-Reinigungstuch einreiben.

Wenn das Produkt sehr schmutzig ist, empfehlen wir, es manuell zu reinigen.

In Ausnahmefällen, in denen mit der oben beschriebenen Methode der Schmutz nicht entfernt werden kann, empfehlen wir die Verwendung eines weißen Polymerschaums (1), der nur mit Wasser verwendet wird.

(1) Im Handel als magischer Schwamm bekannt.

## produtos polidos e amaciados

As peças das séries de acabamento polido e amaciado exigem um tratamento de aplicação e de manutenção especializadas.

O acabamento POLIDO e AMACIADO, para além de ser aconselhado para revestimentos, é também indicado para pavimentos de ambientes residenciais ou comerciais de tráfego ligeiro, não sujeitos a elevada utilização, ou onde não sejam requeridas quaisquer prestações antiderrapantes. A presença esporádica de pequenas não uniformidades ou pontos na superfície deve ser considerada uma característica do material e do seu particular acabamento. Se o produto for colocado em contato direto com o exterior, recomenda-se o uso de soluções protetoras de modo a reduzir a possibilidade de formação de riscos. É da responsabilidade do instalador providenciar sempre a proteção das peças cerâmicas acabadas e limpas, antes da entrega ao cliente, utilizando materiais de proteção adequados (por ex. painéis de aglomerado, folhas de cartão, etc.).

### Cola e Argamassa

Utilizar argamassas para betumação, de preferência de cor idêntica à cor do produto, e de acordo com a especificação do produto - grés.

### Aplicação e primeira limpeza

Na sua aplicação deverá ter o máximo cuidado na remoção das argamassas utilizadas para rejuntar. A limpeza deve ser efetuada, enquanto as argamassas da junta ainda estiverem húmidas, com um pano ou esponja molhada, devendo-se evitar a utilização de detergentes abrasivos que poderão danificar as peças.

Caso as peças apresentem excesso seco de impermeabilizante, a melhor forma de o remover é, esfregando com papel ou pano limpo e seco, podendo essa limpeza ser realizada manualmente ou usando uma monoespátula apropriada. Aconselhamos que esta limpeza seja realizada sem nenhum tipo de materiais abrasivos ou contaminantes.

Uma eventual limpeza com produtos líquidos pode ser potenciadora na diminuição da eficácia do tratamento repelente e protetivo pretendido com a aplicação impermeabilizante.

### Manutenção

A limpeza final e de manutenção do produto deverá ser feito com detergentes próprios para pavimento.

Deverá ser usado detergente de alta concentração diluído conforme a indicação do fornecedor, e dependendo do grau de sujidade, a diluição do detergente poderá ter de ser bastante reduzida, podendo em alguns casos chegar à proporção de 1/3 (detergente/água).

Esfregar com um pano de limpeza de micro-fibra.

No caso de o produto apresentar muita sujidade, aconselhamos a que a limpeza seja feita manualmente.

Em casos muito excecionais da não remoção da sujidade com o método apresentado acima, recomendamos o uso de uma espuma polimérica branca(1) usada apenas com água.

(1) Comercialmente conhecida como esponja mágica.

# technical information

information technique . technische information . informação técnica

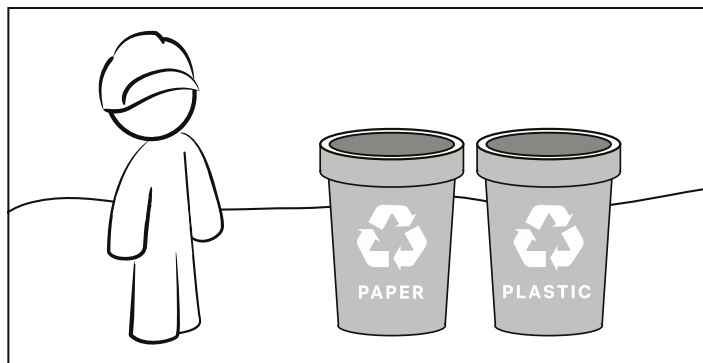

10

## life cycle

The environmental impacts of our products are distributed through their life cycle complying extraction, raw materials transport, production, distribution, use and end of life.

Margres minimize these impacts through good practices of environmental management.

At the end of the product 's life cycle, Margres asks for your best management, favoring the reuse or recycling in a perspective of a circular economy.

## cycle de vie

Les impacts environnementaux de nos produits sont distribués tout au long de leur cycle de vie, dans les phases d'extraction, de transport des matières premières, de production, de distribution, d'utilisation et de fin de vie. Chez Margres on minimise ces impacts environnementaux grâce aux bonnes pratiques de gestion de l'environnement.

Dans l'utilisation et la fin de vie, on appelle à votre meilleure gestion en privilégiant la réutilisation ou le recyclage dans une perspective d'économie circulaire.

## lebenszyklus

Die Umweltbelastung unserer Produkte prägt jede Phase ihres Lebenszyklus – die Gewinnung und das Transport der Rohstoffe, die Produktion, die Lieferung, der Gebrauch, die Entsorgung. Margres verniedlicht durch gute Programme des Umweltmanagements die Umweltbelastung.

In der Phase des Gebrauchs und der Entsorgung bitten wir Sie um eine bevorzugte Auswahl von Weiterverwenden oder Recycling.

## ciclo de vida

Os impactes ambientais dos nossos produtos distribuem-se ao longo do seu ciclo de vida, nas etapas extração, transporte de matérias-primas, produção, distribuição, uso e fim de vida. A Margres minimiza estes impactes ambientais, através de boas práticas de gestão ambiental.

No uso e fim de vida, apelamos à vossa melhor gestão, privilegiando a reutilização ou a reciclagem numa perspectiva de economia circular.

index

colour map

collections

linea collections

useful information

calibers

certification

general sales

conditions

important notes

magres green

laying suggestions

outdoor extra thick

package

pr()tect

symbols

technical information

think zero



# technical information

## technical features

données techniques . technischen eigenschaften . características técnicas

ISO 13006 . EN14411 . GRUPO BIa UGL

technical features caractéristiques techniques technische eigenschaften características técnicas	test method méthode d'essai pruefmethode norma	prescribed value valeur prescrite vorgeschriebener wert valor prescrito	typical value valeur typique typischer wert valor típico	MARGRES
size - lenght and width . dimension - longueur et largeur abmessungen - länge und breite . dimensão - comprimento e largura	ISO 10545 - 2	rectified ±0,3%, max. ± 1 mm not rectified ±0,6%, max. ± 2 mm	conform . conforme gemäß . conforme	
side straightness . rectitude des arêtes kantengeradheit . rectilinearidade das arestas		rectified ±0,3%, max. ± 0,8 mm not rectified ±0,5%, max. ± 1,5 mm	conform . conforme gemäß . conforme	
rectangularity . orthogonalité rechtwinkligkeit . ortogonalidade		rectified ±0,3%, max. ± 1,5 mm not rectified ±0,5%, max. ± 2 mm	conform . conforme gemäß . conforme	
warpage . planéité ebenflächigkeit . planaridade		rectified ±0,4%, max. ± 1,8 mm not rectified ±0,5%, max. ± 2 mm	conform . conforme gemäß . conforme	
thickness . épaisseur dicke . espessura		±5%, max. ± 0,5 mm	conform . conforme gemäß . conforme	
water absorption . absorbtion d'eau wasseraufnahme . absorção de água	ISO 10545-3	≤ 0,5%	conform . conforme gemäß . conforme	
modulus of rupture . module de rupture biegung modul . módulo de ruptura	ISO 10545 - 4	≥ 35N/mm <sup>2</sup>	conform . conforme gemäß . conforme	
breaking strength (s) . résistance à la flexion (s) biegefestigkeit (s) . resistência à flexão (s)		≥ 1300 N	conform . conforme gemäß . conforme	
deep abrasion resistance . résistance à l'abrasion profonde widerstand gegen tiefenverschleiß . resistência à abrasão profunda	ISO 10545-6	≤ 175 mm <sup>3</sup>	conform . conforme gemäß . conforme	
linear thermal expansion . dilatation thermique linéaire lineare wärmeausdehnung . dilatação térmica linear	ISO 10545-8	as indicated by manufacturer comme indiqué par le producteur wie vom hersteller angegeben conforme indicado pelo fabricante	conform . conforme gemäß . conforme	
thermal shock resistance . résistance au chocs thermique temperaturwechselbeständigkeit . resistência ao choque térmico	ISO 10545 - 9	required . nécessaire anforderung . exigida	resistant . résissant beständig . resistente	
frost resistance . résistance au gel frostbeständigkeit . resistência ao gelo	ISO 10545 - 12	required . nécessaire anforderung . exigida	resistant . résissant beständig . resistente	
chemical resistance . résistance à l'attaque chimique chemische beständigkeit . resistência ao ataque químico	ISO 10545 - 13	as indicated by manufacturer comme indiqué par le producteur wie vom hersteller angegeben conforme indicado pelo fabricante	LA - HA resistant . résissant beständig . resistente	
stain resistance . résistance aux taches beständigkeit gegen fleckenbildner . resistência às manchas	ISO 10545 - 14	as indicated by manufacturer comme indiqué par le producteur wie vom hersteller angegeben conforme indicado pelo fabricante	resistant . résissant beständig . resistente	

It is guaranteed the compliance with the values required by norm EN 14411\_Group BIa UGL. Typical Value is merely indicative, which can vary from real data, and does not have the purpose of any trading proposal.  
Le respect de la norme EN14411\_Group BIa UGL est garanti. La valeur typique annoncée étant indicative, pouvant varier de la valeur réelle, n'ayant pas la nature d'une proposition à caractère.  
Es wird die Einhaltung der in der Norm EN 14411\_Group BIa UGL geforderten Werte garantiert. Der angegebene Wert ist lediglich ein Richtwert, der von den tatsächlichen Daten abweichen kann und nicht Teil des Handelsvertrages darstellt.  
É garantido o cumprimento da norma EN 14411\_Group BIa UGL. O valor típico anunciado é meramente indicativo, podendo variar dos dados reais, não tendo a natureza de proposta negociada.

The technical characteristics stated in this catalogue do not invalidate the consultation of updated information on the website and technical data sheets.  
Les caractéristiques techniques déclarées dans ce catalogue n'empêchent pas la consultation de l'information à jour dans le site web et fiches techniques.  
Die in diesem Katalog angegebenen technischen Eigenschaften verzichtet nicht auf das Lesen der aktualisierten Informationen und der technischen Datenblätter auf der Website.  
As características técnicas declaradas neste catálogo, não invalidam a consulta de informação atualizada no site e Fichas Técnicas.

**MARGRES**  
CERAMIC TILES

# technical information

## technical features

données techniques . technischen eigenschaften . características técnicas

ISO 13006 - G . EN14411 - G . GRUPO BIa UGL

technical features caractéristiques techniques technische eigenschaften características técnicas	test method méthode d'essai pruefmethode norma	prescribed value valeur prescrite vorgeschriebener wert valor prescrito	typical value valeur typique typischer wert valor típico	LINEA
size - lenght and width . dimension - longueur et largeur abmessungen - länge und breite . dimensão - comprimento e largura	ISO 10545 - 2	rectified ±0,3%, max. ± 1 mm not rectified ±0,6%, max. ± 2 mm	conform . conforme gemäß . conforme	
side straightness . rectitude des arêtes kantengeradheit . rectilinearidade das arestas		rectified ±0,3%, max. ± 0,8 mm not rectified ±0,5%, max. ± 1,5 mm	conform . conforme gemäß . conforme	
rectangularity . orthogonalité rechtwinkligkeit . ortogonalidade		rectified ±0,3%, max. ± 1,5 mm not rectified ±0,5%, max. ± 2 mm	conform . conforme gemäß . conforme	
warpage . planéité ebenflächigkeit . planaridade		rectified ±0,4%, max. ± 1,8 mm not rectified ±0,5%, max. ± 2 mm	conform . conforme gemäß . conforme	
thickness . épaisseur dicke . espessura		±5%, max. ± 0,5 mm	conform . conforme gemäß . conforme	
water absorption . absorbtion d'eau wasseraufnahme . absorção de água	ISO 10545-3	≤ 0,5%	conform . conforme gemäß . conforme	0,1% (*)
modulus of rupture . module de rupture biegung modul . módulo de ruptura	ISO 10545-4	≥ 35 N/mm <sup>2</sup>	conform . conforme gemäß . conforme	50 N/mm <sup>2</sup>
deep abrasion resistance . résistance à l'abrasion profonde beständigkeit gegen tiefenverschleiß . resistência à abrasão profunda	ISO 10545-6	≤ 175 mm <sup>3</sup>	conform . conforme gemäß . conforme	conform . conforme gemäß . conforme
linear thermal expansion . dilatation thermique linéaire lineare wärmeausdehnung . dilatação térmica linear	ISO 10545-8	as indicated by manufacturer comme indiqué par le producteur wie vom hersteller angegeben conforme indicado pelo fabricante	conform . conforme gemäß . conforme	a ≤ 7x10 <sup>-6</sup> °C <sup>-1</sup>
frost-resistance . résistance au gel frostbeständigkeit . resistência ao gelo	ISO 10545-12	required . nécessaire anforderung . exigida	resistant . résissant beständig . resistente	LA - HA resistant . résissant beständig . resistente
chemical resistance . résistance à l'attaque chimique chemische beständigkeit . resistência ao ataque químico	ISO 10545 - 13	as indicated by manufacturer comme indiqué par le producteur wie vom hersteller angegeben conforme indicado pelo fabricante	resistant . résissant beständig . resistente	LB-HB polished . poli . poliert . polido smooth
stain resistance . résistance aux taches fleckenbeständigkeit . resistências às manchas	ISO 10545-14	as indicated by manufacturer comme indiqué par le producteur wie vom hersteller angegeben conforme indicado pelo fabricante	resistant . résissant beständig . resistente	5 resistant . résissant beständig . resistente ≥ 3 polished . poli . poliert . polido smooth
fire reaction . réaction au feu brandverhalten . reação ao fogo	EN 13823 EN 9239-1	CPR (UE) 305/2011, 2000/147/E, UNI EN 13501-1	conform . conforme gemäß . conforme	Class A1 - 6mm Class A2-s1,d0 - 5,5mm . 3,5mm (walls, mur, wand, revestimento) Class A1fl - 6mm Class A2fl-s1 - 5,5mm . 3,5mm (floor, sol, boden, pavimento)
thermal conductivity . conductivité thermique wärmeleitfähigkeit . condutividade	EN 12524	-	conform . conforme gemäß . conforme	λ = 1,3 W/m °K λ = 0.7 BTU/ft h °F

(\*) Average value referred to ceramic material only . Valeur moyenne se référant au matériau céramique . Durchschnittswert bezogen auf das Keramikmaterial . Valor médio refere-se apenas o material cerâmico.

It is guaranteed the compliance with the values required by norm EN 14411\_Group BIa UGL. Typical Value is merely indicative, which can vary from real data, and does not have the purpose of any trading proposal.  
Le respect de la norme EN14411\_Group BIa UGL est garanti. La valeur typique annoncée étant indicative, pouvant varier de la valeur réelle, n'ayant pas la nature d'une proposition à caractère.  
Es wird die Einhaltung der in der Norm EN 14411\_Group BIa UGL geforderten Werte garantiert. Der angegebene Wert ist lediglich ein Richtwert, der von den tatsächlichen Daten abweichen kann und nicht Teil des Handelsvertrages darstellt.  
É garantido o cumprimento da norma EN 14411\_Group BIa UGL. O valor típico anunciado é meramente indicativo, podendo variar dos dados reais, não tendo a natureza de proposta negociada.

Linea is not intended for use in areas subject to the passage of heavy concentrated loads (for example, hard-wheeled trolleys).  
Linea n'est pas conçu pour être utilisé dans des zones soumises au passage de charges lourdes et concentrées (par exemple, des chariots à roues rigides).  
Linea ist nicht für den Einsatz in Bereichen bestimmt, in denen konzentrierte, schwere Lasten bewegt werden (z. B. Wagen mit harten Rädern).  
Linea não é indicado para utilização em zonas sujeitas a passagem de cargas pesadas concentradas (por exemplo, carrinhos com rodas rígidas).

The technical characteristics stated in this catalogue do not invalidate the consultation of updated information on the website and technical data sheets.  
Les caractéristiques techniques déclarées dans ce catalogue n'empêchent pas la consultation de l'information à jour dans le site web et fiches techniques.  
Die in diesem Katalog angegebenen technischen Eigenschaften verzichtet nicht auf das Lesen der aktualisierten Informationen und der technischen Datenblätter auf der Website.  
As características técnicas declaradas neste catálogo, não invalidam a consulta de informação atualizada no site e Fichas Técnicas.

index

colour map

collections

linea collections

useful information

calibers

certification

general sales

conditions

important notes

magres green

laying suggestions

outdoor extra thick

package

pr()tect

symbols

technical information

think zero



# technical information



### slipping resistance

résistance à la glissance
rutschfestigkeit
resistência ao escorregamento

DIN EN 16165







(Annex B. Annexe B . Anhang B. Anexo B)

In this test, an operator stands on a surface covered with tiles for testing. The surface, initially horizontal, is gradually tilted until the moment when the operator starts to slip. The angle of tilt of the surface when slipping starts provides the rating.

Le test de mesure de ce paramètre prévoit la présence d'un opérateur sur un plan revêtu des carreaux à tester. Le plan, initialement horizontal, est progressivement incliné jusqu'à ce que l'opérateur commence à glisser. L'angle correspondant à l'inclinaison du plan au moment où l'opérateur commence à glisser détermine la classification.

Hier steht ein Bediener auf einer mit zu testenden Fliesen verkleideter Fläche. Die anfangs horizontale Fläche wird nach und nach geneigt, bis der Bediener zu rutschen beginnt. Der Neigungswinkel der Fläche bei Rutschbeginn bestimmt die Bewertungsgruppe.

Este ensaio prevê um operador em pé sobre uma superfície revestida com os mosaicos a testar. A superfície horizontal é inclinada progressivamente até ao momento em que o operador começa a escorregar. O ângulo correspondente à inclinação da superfície no momento do escorregamento determina a classificação.

	<b>α &lt;6°</b>	not classified non classé nicht klassifizierbar não classificado
	<b>6° ≤ α ≤ 10°</b>	<b>R9</b>
	<b>10° &lt; α ≤ 19°</b>	<b>R10</b>
	<b>19° &lt; α ≤ 27°</b>	<b>R11</b>
	<b>27° &lt; α ≤ 35°</b>	<b>R12</b>
	<b>α &gt; 35°</b>	<b>R13</b>

(Annex A. Annexe A . Anhang A. Anexo A)

The method aims to measure the tiles' suitability for laying in locations where people walk barefoot (e.g. edges of swimming-pools, showers, etc.) An operator walks barefoot over a tilting surface laid with the tiles for testing, wet with a soap and water solution. The surface is gradually tilted and the angle of tilt at which the operator starts to slip provides the tiles' rating, as shown in the table below.

La méthode vise à mesurer la conformité des carreaux pour une pose sur des espaces au sein desquels l'on marche pieds nus (abords de piscine, douche, etc.). Un opérateur marche pieds nus sur un plan inclinable sur lequel sont posés des carreaux mouillés à l'aide d'une solution d'eau et savon. Le plan est progressivement incliné et l'angle correspondant à l'inclinaison du plan au moment où l'opérateur commence à glisser détermine la classification des carreaux comme indiquée ci-dessous:

Diese Methode misst die Eignung der Fliesen für die Verlegung in Barfuss-Bereichen (z.B. Schwimmbeckenränder, Duschen, usw.). Ein Bediener geht barfuss auf einer geneigten Fläche, auf der mit einer Seifenwasserlösung nasse Fliesen verlegt sind. Die Fläche wird nach und nach geneigt und der Neigungswinkel, an dem der Bediener zu rutschen beginnt, bestimmt die Bewertungsgruppe der Fliesen, laut folgender Tabelle:

O método visa medir a idoneidade dos mosaicos para o assentamento em ambientes onde se caminha com os pés descalços (ex. bordas de piscinas, duches, etc.). Um operador caminha com os pés descalços sobre uma superfície inclinável na qual são assentados os mosaicos submetidos ao ensaio molhados com uma solução de água e sabão. A superfície é progressivamente inclinada e o ângulo no qual o operador começa a escorregar determina a classificação dos mosaicos, conforme indicado na tabela seguinte:

<b>α &lt;12°</b>	not classified non classé nicht klassifizierbar não classificado
<b>12° ≤ α &lt; 18°</b>	<b>A</b>
<b>18° ≤ α &lt; 24°</b>	<b>B (A+B)</b>
<b>α ≥ 24°</b>	<b>C (A+B+C)</b>

(Annex C. Annexe C . Anhang C. Anexo C)

**Pendulum Test**

This is an equipment that has a pendulum set on a metallic structure.

This simulates the action of a shod foot slipping and measures dynamic coefficient of friction by swinging an imitation heel clad with standard soling rubber over the test surface. The test is done horizontally because it was designed to replicate a pedestrian heel strike, the point at which most slips occur. The equipment allows to accurately test the slip potential on clean and dry or contaminated floors. It is used mainly in wet more dangerous environments.

**Test du pendule**

Il s'agit d'un appareil qui a un pendule assemblé dans une structure métallique.

Ce pendule simule l'usage de chaussures au sol pour mesurer la résistance frictionnelle entre le patin en caoutchouc monté dans l'extrémité du bras et la surface à tester.

Ce test est fait à l'horizontale puisqu'il a été conçu pour repliquer le contact du pied avec le sol jusqu'au point où le plus de glissance peut survenir. Cet appareil nous permet de tester, en termes de glissance, des matériaux secs ou humides. Il est principalement utilisé dans un état humide, qui est le plus défavorable.

**Pendeltest**

Dies ist eine Vorrichtung mit einem Pendelset auf einer Metallstruktur.

Der Test simuliert die Einwirkung eines beschuhten Fußes auf die Oberfläche und misst den dynamischen Reibungskoeffizienten indem ein gummibesohlter Schuhabsatz über den Testbelag gleitet. Er wird in der Waagerechten durchgeführt, weil er den Fußkontakt auf trockenen und sauberen sowie auf verschmutzten Böden. Er wird hauptsächlich auf nasse und gefährliche Untergründe angewendet.

**Teste do Pêndulo**

Trata-se de um equipamento que tem um pêndulo montado numa estrutura metálica.

O pêndulo simula a ação do calçado no pavimento ao medir a resistência friccional entre um patim de borracha montado na ponta do braço e a superfície a testar. O teste é feito na forma horizontal pois foi desenhado para replicar o contacto do pé com o solo até ao ponto onde o maior escorregamento pode ocorrer.

Este equipamento permite ensaiar, em termos de escorregamento, materiais secos ou húmidos. Utiliza-se principalmente o estado húmido que é o mais desfavorável.

<b>0 - 24</b>	high slip potential haut risque de glissance geringe rutschgefahr alto risco de escorregamento
<b>25 - 35</b>	moderate potential slip potential risque modéré de glissance mittlere rutschgefahr moderado risco de escorregamento
<b>≥ 36</b>	low slip potential bas risque de glissance hohe rutschgefahr baixo risco de escorregamento

**MARGRES**  
CERAMIC TILES

# technical information

## V

### shade variation

denuançage
farbspiel
destonalização

ANSI A137.1

Tiles may vary in color, texture, or appearance according to the manufacturer’s design for that particular tile series or product line. The following aesthetic class designations have been provided in the Table, so that the manufacturer may communicate the aesthetic characteristics of a particular tile product.

La couleur, la structure et l’aspect des carreaux peuvent varier en fonction des spécifications du producteur définies pour la série de carreaux ou la ligne de produit spécifique. Les désignations de « classe esthétique » suivantes sont fournies dans le Tableau pour permettre au producteur de communiquer les caractéristiques esthétiques d’un produit particulier.

Die Farbe, die Struktur und das Aussehen der Fliesen können auf Grund der für die besondere Fliesenserie oder Produktreihe festgelegten Spezifikationen des Herstellers variieren. Die folgenden Bestimmungen der „ästhetischen Kategorie“ finden sich in Tabelle, damit der Hersteller die ästhetischen Charakteristiken eines besonderen Produkts mitteilen kann.

Os mosaicos podem variar em cor, textura ou aspeto conforme o desenho do fabricante para essa série de mosaicos ou linha de produtos em particular. As seguintes designações de classe estética foram colocadas na Tabela para que o fabricante possa comunicar as características estéticas de determinado produto de mosaico.

<b>V0</b>	<b>V1</b>	<b>V2</b>	<b>V3</b>	<b>V4</b>
None Nul Gleich Null Nulo	Minor Léger Leicht Ligeiro	Low Faible Gering Baixo	Medium Moyen Mittelmäßig Médio	Major Élevé Stark Alto
<b>Very uniform appearance.</b> Pieces of the same shade value are very uniform.	<b>Uniform appearance.</b> Differences among pieces from the same production run are minimal.	<b>Slight variation.</b> Clearly distinguishable differences in texture and/or pattern within similar colors.	<b>Moderate variation.</b> While the colors and or texture present on a single piece of tile will be indicative of the colors and or texture to be expected on the other tiles, the amount of colors and or texture on each piece may vary significantly. It is recommended that the range be viewed before selection.	<b>Substantial variation.</b> Random color and or texture differences from tile to tile, so that one tile may have totally different colors and or texture from that on other tiles. Thus, the final installation will be unique. It is recommended that the range be viewed before selection.
<b>Aspect très uniforme.</b> Les pièces de la même variante de couleur sont très uniformes.	<b>Aspect uniforme.</b> Les différences entre les pièces d'un même lot de production sont minimes.	<b>Variations minimes.</b> Différences clairement visibles au niveau de la structure et/ ou du design entre les pièces caractérisées par des couleurs analogues.	<b>Variations modérées.</b> Même si les couleurs et la structure d'une seule pièce peuvent identifier les couleurs et les structures des autres pièces, la variation de la couleur et de la structure de chaque pièce peut être significative. Il est conseillé d'examiner la gamme avant de choisir.	<b>Variations importantes.</b> Différences casuelles au niveau de la couleur ou de la structure d'un carreau à l'autre. Un carreau peut ainsi présenter des couleurs et/ou une structure totalement différentes de celles d'autres carreaux. Le résultat final sera donc unique et non reproductible. Il est conseillé d'examiner la gamme avant de choisir.
<b>Sehr gleichmäßiges Aussehen.</b> Die Teile der gleichen Farbvariante sind sehr gleichmäßig.	<b>Gleichmäßiges Aussehen.</b> Die Unterschiede zwischen den Teilen eines Produktionsloses sind minimal.	<b>leichte Variationen.</b> Klar erkennbare Unterschiede in Texturen und/oder Muster mit ähnlichen Farben.	<b>Variations moderadas.</b> Embora as cores e/ou a textura presentes numa peça de mosaico sejam indicativas das cores e/ ou textura que se espera nos outros mosaicos, a quantidade de cores e/ou textura em cada peça pode variar significativamente. Recomenda-se que a gama seja vista antes da seleção.	<b>Wesentliche Variationen.</b> Zufällige Farb- oder Strukturunterschiede der einzelnen Fliesen, in der Folge können sich Farben und/oder Struktur vollkommen von den andern Fliesen unterscheiden. Deshalb ist das Endergebnis einmalig und unwiederholbar. Vor der eventuellen Wahl ist es ratsam das Produktspektrum zu prüfen.
<b>Aspeto muito uniforme.</b> Peças com o mesmo valor de tonalidade são muito uniformes.	<b>Aspeto uniforme.</b> As diferenças entre as peças da mesma fase de produção são mínimas.	<b>Ligeira variação.</b> É possível distinguir diferenças claramente na textura e/ou padrão com cores semelhantes.		

## index

## colour map

## collections

## linea collections

## useful information

### calibers

### certification

## general sales

### conditions

### important notes

### magres green

## laying suggestions

## outdoor extra thick

## package

## pr()tect

## symbols

## technical information

### think zero



# package

— emballage . verpackung . embalagem

size format formato (cm)	thickness épaisseur dicke espesura	box . boîte . karton . caixa			pallet . palette . palette . paleta			pallet dimension . dimensions des palettes paletten abmessungen . dimensões paletes		
		pieces pièces stück peças	sqm m <sup>2</sup>	weight poids gewicht peso (kg)	boxes boîtes kartonen caixas	sqm m <sup>2</sup>	weight poids gewicht peso (kg)	width largeur breite largura (cm)	length longueur laenge comprimento (cm)	height hauteur höhe altura (cm)
<b>90x90</b>	9,5 mm	2	1,60	34,30	25	40,00	925	93	120	105
	10,5 mm	2	1,60	39,50	25	40,00	1015	93	120	105
	11,0 mm	2	1,60	41,40	25	40,00	1060	93	120	105
	20,0 mm	1	0,81	37,30	30	24,30	1140	95	95	83
<b>89x89</b>	9,5 mm	2	1,58	35,10	25	39,50	900	93	120	105
<b>88x88</b>	9,5 mm	2	1,55	33,60	25	38,75	862	93	120	105
<b>60x120</b>	9,5 mm	2	1,44	32,30	36	51,84	1188	93	120	75
	10,5 mm	2	1,44	35,60	30	43,20	1110	93	120	75
	11,0 mm	2	1,44	37,30	30	43,20	1160	93	120	75
	20,0 mm	1	0,72	32,50	32	23,00	1060	70	125	85
<b>60x60</b>	8,5 mm	4	1,44	28,80	30	43,20	893	80	120	75
	9,5 mm	3	1,08	24,10	40	43,20	995	80	120	75
	10,0 mm	3	1,08	25,40	40	43,20	1050	80	120	75
	14,0 mm	2	0,72	23,70	40	28,80	980	80	120	75
	20,0 mm	2	0,71	31,50	32	22,72	1028	80	120	75
<b>45x90</b>	9,0 mm	4	1,60	33,90	24	38,40	839	100	120	60
<b>40x120</b>	20,0 mm	2	0,96	43,50	20	19,20	895	86	124	55
<b>30x60</b>	8,5 mm	6	1,08	19,50	48	51,84	961	80	120	75
	9,5 mm	6	1,08	24,10	48	51,84	1190	80	120	75
	10,0 mm	5	0,90	21,20	48	43,20	1050	80	120	75
<b>30x30</b>	8,5 mm	16	1,44	28,80	40	57,60	1180	80	120	75
	12,0 mm	12	1,08	30,50	40	43,20	1250	80	120	75
<b>20x120</b>	8,0 mm	7	1,68	31,00	24	40,32	769	77	128	50
<b>20x90</b>	9,0 mm	6	1,08	22,90	54	58,32	1265	120	100	75

size format formato (cm)	thickness épaisseur dicke espesura	box . boîte . karton . caixa			pallet . palette . palette . paleta			pallet dimension . dimensions des palettes paletten abmessungen . dimensões paletes		
		pieces pièces stück peças	sqm m <sup>2</sup>	weight poids gewicht peso (kg)	boxes boîtes kartonen caixas	sqm m <sup>2</sup>	weight poids gewicht peso (kg)	width largeur breite largura (cm)	length longueur laenge comprimento (cm)	height hauteur höhe altura (cm)
<b>120x260</b>	6,0 mm	1	3,12	44,00	18	56,16	810,00	136,0	275,0	28,0
<b>120x120</b>	6,0 mm	2	2,88	40,60	24	69,12	955,19	130,0	130,0	58,0
<b>100x300</b>	3,5 mm	1	3,00	23,40	20	60,00	538,00	111,0	320,0	23,0
	5,5 mm	1	3,00	37,00	13	39,00	551,00	111,0	320,0	23,0
<b>100x250</b>	6,0 mm	1	3,00	41,40	13	39,00	608,20	111,0	320,0	23,0
	5,5 mm	1	2,50	28,75	13	32,50	443,75	111,0	264,0	23,0
<b>100x100</b>	6,0 mm	1	2,50	34,50	13	32,50	518,50	111,0	264,0	23,0
	3,5 mm	3	3,00	23,40	25	75,00	605,00	111,0	111,0	64,0
<b>100x100</b>	5,5 mm	2	2,00	25,40	25	50,00	595,00	111,0	111,0	64,0
	6,0 mm	2	2,00	27,60	25	50,00	710,00	111,0	111,0	64,0
<b>60x120</b>	6,0 mm	3	2,16	30,25	32	69,12	968,00	130,0	130,0	58,0
<b>50x100</b>	3,5 mm	5	2,50	20,00	32	80,00	660,00	111,0	111,0	64,0
	5,5 mm	3	1,50	18,90	32	48,00	572,00	111,0	111,0	64,0
	6,0 mm	3	1,50	20,70	32	48,00	682,40	111,0	111,0	64,0

The featured weights are approximate. The quantities of Sqm (m<sup>2</sup>)/pieces per box/palette may exceptionally vary and shall be confirmed by Margres.  
 Les poids présentés sont approximatifs. Les quantités m<sup>2</sup>/pièces par boîte/palette peuvent exceptionnellement varier. Nous vous prions donc de bien vouloir confirmer auprès de Margres.  
 Die angegebenen Gewichte sind Näherungswerte. Die Mengen, m<sup>2</sup>/Stücke pro Verpackung/Palette können in Einzelfällen abweichen. Sie sollten also von Margres bestätigt werden.  
 Os pesos apresentados são aproximados. As quantidades m<sup>2</sup>/peças por caixa/palette podem excepcionalmente variar, pelo que agradecemos a confirmação junto da Margres.

# pallet dimension

— dimensions des palettes . paletten abmessungen . dimensões das paletes

size format formato (cm)	width largeur breite largura (cm)	length longueur laenge comprimento (cm)	height hauteur höhe altura (cm)
<b>90x90</b>	93	120	105
<b>89x89</b>	93	120	105
<b>88x88</b>	93	120	105
<b>60x120</b>	93	120	105
<b>60x60</b>	80	120	75
<b>45x90</b>	100	120	60
<b>40x120</b>	82	124	79
<b>30x60</b>	80	120	75
<b>30x30</b>	80	120	75
<b>20x120</b>	77	128	50
<b>20x90</b>	100	120	75

## LINEA

<b>120x260</b>	136	275	28
<b>120x120</b>	130,2	130,2	57,9
<b>100x300</b>	111	322	23
<b>100x250</b>	111	322	23
<b>100x100</b>	111	111	64
<b>60x120</b>	130	130	58
<b>50x100</b>	111	111	64

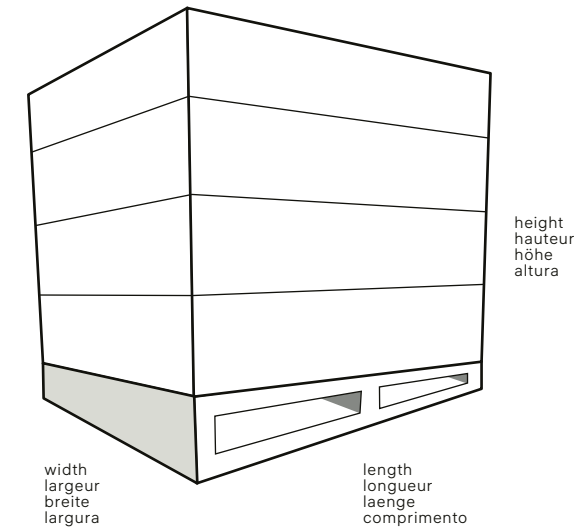

# size reading

— lire le format . leseformat . leitura do formato

size format formato (cm)	reference référence referenz referência
120x260	<b>1226</b>
120x120	<b>1212</b>
100x300	<b>1030</b>
100x250	<b>1025</b>
100x100	<b>1010</b>
90x90	<b>99</b>
89x89	<b>99</b>
88x88	<b>99</b>
60x120	<b>62</b>

size format formato (cm)	reference référence referenz referência
60x60	<b>66</b>
50x100	<b>510</b>
45x90	<b>49</b>
44x88	<b>49</b>
40x120	<b>412</b>
30x60	<b>36</b>
30x30	<b>33</b>
20x120	<b>212</b>
20x90	<b>29</b>

size format formato (cm)	reference référence referenz referência
9,5x90	<b>109</b>
9,5x30	<b>13</b>
8x120	<b>812</b>
8x90	<b>89</b>
8x88	<b>89</b>
8x60	<b>86</b>

## examples

exemples . beispiele . exemplos

**36 CT1 NR**    **66 T21 P**

size: **36**    size: **66**  
 colour: **CT1**    colour: **T21**  
 surface: **NR**    surface: **P**

index

colour map

collections

linea collections

useful information

calibers

certification

general sales

conditions

important notes

magres green

laying suggestions

outdoor extra thick

package

pr()tect

symbols

technical information

think zero



# calibers

calibres . kaliber . calibres

# calibers

calibres . kaliber . calibres

size format formato formato (cm)	thickness épaisseur dicke espesura	P	X	V	S	T	C	R
<b>90x90</b>	9,5 mm	-	895,0 x 895,0	890,0 x 890,0	-	-	-	-
	10,5 mm	-	895,0 x 895,0	890,0 x 890,0	-	-	-	-
	11,0 mm	-	895,0 x 895,0	890,0 x 890,0	-	-	-	-
	20,0 mm	898,0x898,0	-	-	-	-	-	-
<b>89x89</b>	9,5 mm	-	-	890,0 x 890,0	-	-	-	-
<b>88x88</b>	9,5 mm	-	-	-	881,0 x 881,0	-	-	-
<b>60x120</b>	9,5 mm Prestige + Endless	-	-	-	-	-	595,0 x 1192,0	592,0 x 1187,0
	9,5 mm	-	-	-	-	599,8 x 1201,6	-	-
	10,5 mm	-	-	-	-	599,8 x 1201,6	-	-
	11,0 mm	-	-	-	-	599,8 x 1201,6	-	-
	20,0 mm	598,0x1198,0	-	-	-	-	-	-
<b>60x60</b>	8,5 mm Prestige	-	-	-	-	-	595,0 x 595,0	592,0x592,0
	8,5 mm	-	-	-	-	599,8 x 599,8	595,0 x 595,0	-
	9,5 mm	-	-	-	-	599,8 x 599,8	595,0 x 595,0	-
	10,0 mm	-	-	-	-	599,8 x 599,8	595,0 x 595,0	-
	14,0 mm	-	-	-	-	599,8 x 599,8	595,0 x 595,0	-
	20,0 mm	598,0 x 598,0	-	-	-	-	595,0 x 595,0	-
<b>45x90</b>	9,0 mm	-	446,5 x 895,0	444,0 x 890,0	-	-	-	-
<b>30x60</b>	8,5 mm	-	-	-	-	298,9 x 599,8	296,5 x 595,0	-
	9,5 mm	-	-	-	-	298,9 x 599,8	296,5 x 595,0	-
	10,0 mm	-	-	-	-	298,9 x 599,8	296,5 x 595,0	-

size format formato formato (cm)	thickness épaisseur dicke espesura	A	B	D	E	H	L	M
<b>30x30</b>	8,5 mm	296,1 x 296,1	297,4 x 297,4	298,7 x 298,7	300,0 x 300,0	301,3 x 301,3	302,6 x 302,6	303,9 x 303,9
	12,0 mm	296,1 x 296,1	297,4 x 297,4	298,7 x 298,7	300,0 x 300,0	301,3 x 301,3	302,6 x 302,6	303,9 x 303,9
<b>20x90</b>	9,0 mm	-	200,0 x 896,0	200,4 x 898,0	200,9 x 900,0	201,3 x 902,0	201,8 x 904,0	-

size format formato formato (cm)	thickness épaisseur dicke espesura	P	K	J	B	C	D	E	H	L
<b>40x120</b>	20,0 mm	398,0 x 1198,0	-	-	-	-	-	-	-	-
<b>20x120</b>	8,0 mm	-	-	-	202,5 x 1200,1	203,0 x 1201,4	203,5 x 1202,7	204,0 x 1204,0	204,5 x 1205,3	205,0 x 1206,0
	8,0 mm NR	-	192,0 x 1192,0	196,0 x 1196,0	-	-	-	-	-	-

## LINEA

size format formato formato (cm)	thickness épaisseur dicke espesura	3plus mm
<b>100x300</b>	3,5 mm	1000,0 x 3000,0
<b>100x100</b>	3,5 mm	1000,0 x 1000,0
<b>50x100</b>	3,5 mm	500,0 x 1000,0

size format formato formato (cm)	thickness épaisseur dicke espesura	5plus mm
<b>100x300</b>	5,5 mm	997,0 x 3000,0
<b>100x250</b>	5,5 mm	997,0 x 2500,0
<b>100x100</b>	5,5 mm	997,0 x 997,0
<b>50x100</b>	5,5 mm	497,0 x 997,0

size format formato formato (cm)	thickness épaisseur dicke espesura	6 mm
<b>120x260</b>	6,0 mm	1198,0 x 2600,0
<b>120x120</b>	6,0 mm	1198,0 x 1198,0
<b>100x300</b>	6,0 mm	997,0 x 3000,0
<b>100x250</b>	6,0 mm	997,0 x 2500,0
<b>100x100</b>	6,0 mm	997,0 x 997,0
<b>60x120</b>	6,0 mm	598,0 x 1198,0
<b>50x100</b>	6,0 mm	497,0 x 997,0

## useful information

[calibers](#)

[certification](#)

[general sales conditions](#)

[important notes](#)

[magres green](#)

[laying suggestions](#)

[outdoor extra thick](#)

[package](#)

[pr\(\)tect](#)

[symbols](#)

[technical information](#)

[think zero](#)



# symbols

— symbologie . zeichen . simbologia

## FULL BODY PORCELAIN

Full Body Porcelain  
Grès Cérame Pleine Masse  
Durchgefärbtes Feinsteinzeug  
Grés Porcelânico Toda a Massa

## DIGITEK PORCELAIN STONEWARE

Fully digital graphics  
Graphisme totalement digital  
Komplett digitale Grafik  
Produto com gráfica totalmente digital

## LAMINATED PORCELAIN STONEWARE

Reduced thickness porcelain tile  
Grès cérame fine épaisseur  
Feinsteinzeug mit geringerer Dicke  
Grés Porcelânico de baixa espessura

## TECHNICAL FULL BODY PORCELAIN

Technical Full Body Porcelain  
Grès Cérame Pleine Masse Technique  
Technishes, Durchgefärbtes Feinsteinzeug  
Grés Porcelânico Toda a Massa Técnico

## UGL

Unglazed  
Non émaillé  
Unglasierte  
Não esmaltado

## M<sup>2</sup>

Decors sold per Sqm (m<sup>2</sup>)  
Décorations vendues au m<sup>2</sup>  
Dekorationen verkauft pro m<sup>2</sup>  
Decorações vendidas a m<sup>2</sup>

## STOCK OFF

Limited stock. Additional discount on the price list  
Stock limité. Remise supplémentaire sur le tarif  
Begrenzt Lager. Extra-rabatt Auf den Preisliste  
Stock limitado. Desconto adicional sobre o preço de tabela



Low traffic  
Faible passage  
Leicht Frequentiert  
Baixo tráfego



Medium traffic  
Passage modéré  
Mittlere Frequentierung  
Médio tráfego



Medium high traffic  
Passage modéré à élevé  
Mittlere bis starke Frequentierung  
Médio alto tráfego



High traffic  
Fort Passage  
Starke Frequentierung  
Alto tráfego

## PR()TECT

Antibacterial for Life.

An exclusive line of extremely high performance antimicrobial floor and wall tiles, designed for healthy, safe and protected living spaces.  
Une ligne exclusive de sols et revêtements antibactériens aux performances très élevées, pour un habitat sain, sûr et protégé.  
Eine exklusive Linie an hochwertigen Fußböden und antibakteriellen Wandverkleidungen, für ein gesundes, sicheres und geschütztes Leben.  
Uma linha exclusiva de pavimentos e revestimentos antimicrobianos de altíssima performance, projetada para ambientes saudáveis, seguros e protegidos.

# laying suggestions

— suggestions de pose . anwendungsvorschläge . sugestões de aplicação —

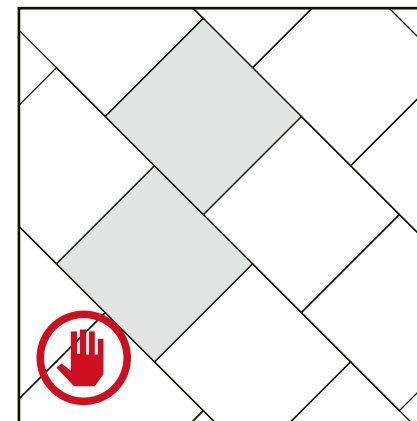
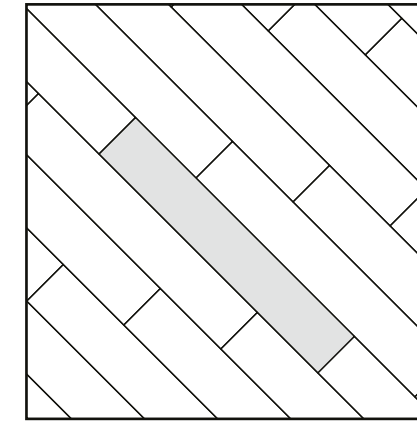
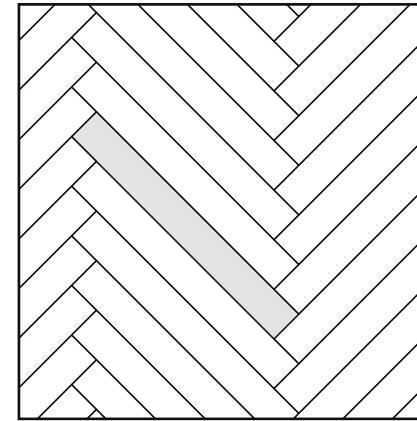

Not recommended  
Non recommandé  
Nicht empfohlen  
Não recomendado

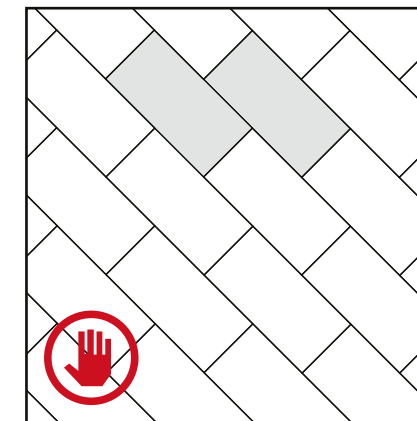

Not recommended  
Non recommandé  
Nicht empfohlen  
Não recomendado

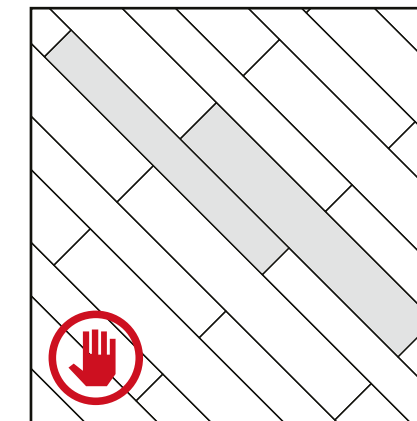

Not recommended  
Non recommandé  
Nicht empfohlen  
Não recomendado



# general sales conditions

## 1 - Applicability of Conditions

**1.1.** The general conditions listed and specified below - hereinafter referred to as the "CONDITIONS" - form an integral part of the contract for the purchase and sale of mosaics and other ceramic products - hereinafter referred to as the "PRODUCT" or the "PRODUCTS" - manufactured by Margres - Gres Panaria Portugal, S.A., also referred to as the "MANUFACTURER".

**1.2.** Except in specific or exceptional cases, in which the application of these conditions is expressly modified by written agreement and signed by the MANUFACTURER, they represent the exclusive conditions applied to such sale. If one or more parts of these CONDITIONS or contracts, individually considered and of which they form part, are in any way deemed null and void, invalid or unenforceable by reason of force majeure, the general or particular CONDITIONS shall remain valid as a whole and the invalid conditions shall be replaced by new provisions reproducing, as far as possible, the original intention of the parties.

### 2 - Execution of the Sales Contract - Delivery of Products

**2.1.** The contract shall be signed when the proposing party or the purchaser becomes aware of its written acceptance by the counterpart.

**2.2.** An order which has not been confirmed in writing shall under no circumstances be deemed as not having been accepted unless it has been carried out by the MANUFACTURER by sending or delivering the PRODUCTS. The partial delivery of the ordered PRODUCTS does not imply acceptance of the entire order, but only of the part concerning the PRODUCTS that have actually been delivered.

**2.3.** Unless otherwise agreed in writing and in advance, the delivery of the PRODUCTS shall be made exclusively Ex-works.

**2.4.** Unless otherwise expressly agreed, all dates indicated for delivery purposes shall be considered as approximate dates.

### 3 - Product Characteristics - Guarantee - Complaints

**3.1.** The PRODUCTS manufactured by Margres - Gres Panaria Portugal, S.A. are produced in accordance with the applicable European standards. The MANUFACTURER preferably sells to professional resellers, who are responsible for providing correct and appropriate technical information to end users or retailers.

The classification of the PRODUCTS is indicated by the MANUFACTURER in advertising material and/or price lists. Consequently, the buyer must use the PRODUCTS in accordance with the MANUFACTURER's specifications.

To facilitate the suggestion of use and adapt the standard specification to the specific production of the MANUFACTURER, all products, price lists or catalogues contain specific symbols indicating the recommended use for each product by the MANUFACTURER.

**3.2.** Differences in tonality or chrominance, if any, do not result from defects in the PRODUCT, rather being a specific characteristic of the ceramic material that has been subjected to firing at high temperatures. The special characteristic of "freezing resistance" only applies to products which the MANUFACTURER has specifically guaranteed for that purpose by means of express indication in its advertising material and/or price lists. In case of absence of this indication , the products will be solely and exclusively considered for indoor use or, in any case, for use in places that are not exposed to atmospheric elements that alter the resistance characteristics or the original look of the PRODUCT (e.g. atmospheric precipitation, sun, humidity, low temperatures, etc.).

**3.3.** Mosaics with polished faces may change their appearance when used on the floor of rooms that have access from the outside, or rooms where intense pedestrian traffic is expected. Polished tiles can also be slippery, especially when wet or damp. For this reason, the MANUFACTURER advises against the use of these PRODUCTS in public places. For places where people circulate intensively, the buyer should only purchase PRODUCTS classified by the MANUFACTURER as "PEI V" or "Full Body Porcelain Stoneware", in particular those PRODUCTS that the MANUFACTURER specifically recommends for use in public places.

**3.4.** The presentations of the PRODUCTS in leaflets or in any other promotional material by the MANUFACTURER are merely illustrative and do not necessarily represent the aesthetic end-result arising from the installation of that specific product.

**3.5.** The MANUFACTURER guarantees the good quality and the absence of defects in the PRODUCTS supplied.

The guarantee does not apply to PRODUCTS classified by the MANUFACTURER as inferior to the 1st. choice quality, or to the stocks of products that have been discontinued, when they are sold in bulk or indicated as special lot.

**3.6.** The MANUFACTURER shall not be liable for any defects and/or anomalies existing in the PRODUCTS that do not result from their technical specifications but rather arise from the improper use of the PRODUCTS by the purchasers and/or third parties acting on their behalf. In particular, the MANUFACTURER does not accept any complaints or disputes related to the above described situations.

**3.7.** Complaints arising from the existence of evident or hidden defects must be made to the MANUFACTURER in writing by the purchaser within 60 days from the date of delivery of the goods. The Manufacturer's liability for defects inherent in the products delivered to the Buyer is expressly limited to 2 years from the date of receipt of the goods by the Buyer.

**3.8.** In general, the guarantee only applies to defects found in products which have not yet been applied. For defects detected after the PRODUCTS have been applied, the guarantee can only apply if the MANUFACTURER has confirmed that the installation of the PRODUCT has been carried out in accordance with the best rules of the activity (DIN 18352), as well as in accordance with the procedures described in the MANUFACTURER's application and maintenance manual.

**3.9.** The guarantee granted by the MANUFACTURER is limited to the replacement of the defective products with other products of the same type without defect, plus transport costs. The reimbursement of any other costs and/or expenses, in particular demolition and relocation costs, is expressly excluded. In any case, the MANUFACTURER's guarantee does not exceed five times the value of the material claimed, up to a maximum of 10,000 Euros.

**3.10.** The MANUFACTURER is not responsible for any claims due to a classification of ceramic materials made by certification and control bodies other than the European ones, indicated in article 3.1, based on technical specifications that do not correspond to those indicated by the MANUFACTURER. Any specialised technical analysis requested by the buyer will be based on the correspondence of the materials sold with the technical characteristics indicated by the MANUFACTURER, at that time in force in Portugal.

### 4 - Prices and Payment Conditions

**4.1.** The sale prices of the PRODUCTS are those indicated in the MANUFACTURER's price list in force on the date of confirmation of order. For sales contracts with separate deliveries, the price shall be the one set out in the price list in force on the date of each delivery, unless the contracting parties have stipulated differently.

For PRODUCTS aimed at foreign markets the price will be calculated, by indication of the MANUFACTURER, in the foreign currency of the country of destination or in Euros.

**4.2.** Unless otherwise expressly agreed, payments shall be made by bank transfer within 30 days from the date of invoice. All bank and transfer charges shall be borne by the purchaser. In the event of delay in making payment, the MANUFACTURER, together with any other losses, shall be entitled, without prior notice to the purchaser, to apply a default and punitive interest rate equivalent to the 6-month EURIBOR tax plus 5%.

### 5 - Manufacturer's Agents

**5.1.** The MANUFACTURER's agents promote the sale of the PRODUCTS and are not authorised to act in the name and on behalf of the MANUFACTURER, unless they obtain express specific authorisation to do so.

**5.2.** Orders received by agents are not binding on the MANUFACTURER and must therefore be expressly accepted in writing by the MANUFACTURER itself.

### 6 – Ownership Reservation

**6.1.** It is agreed between the parties that the sale of the PRODUCTS shall be made with ownership reservation by the MANUFACTURER until full payment of the agreed price is entirely made by the purchaser. However, the risk of loss of the goods is transferred to the purchaser upon delivery of the PRODUCTS.

**6.2.** In case of sales to foreign countries, when the goods are sold and delivered to third parties within the framework of the Buyer's normal business activities and the ownership of the goods has not yet been transferred, the MANUFACTURER's ownership reservation remains valid vis-à-vis third parties.

**6.3.** In the event of delays in payment the MANUFACTURER has the right, without the need for any formality including any prior notice to the purchaser, to collect all goods subject to ownership reservation and if legally enshrined, all credit titles to third parties, and the MANUFACTURER expressly reserves the right to use all legal means at its disposal to recover damages it has suffered or may suffer as a result of defaulting conduct of the purchaser.

### 7 - Case of Force Majeure

**7.1.** The MANUFACTURER shall not be liable to the purchaser for any breach of contract, including the non-delivery or late delivery of the PRODUCT, caused by facts beyond its control, such as the non-delivery or late delivery of materials by suppliers, facilities breakdowns, strikes, facts of nature, interruptions in power supply, suspension or transport difficulties.

### 8 - Applicable Law - Competent Jurisdiction

**8.1.** In the interpretation, integration or rectification of these conditions, the provisions contained in Decree-Law No. 67/2003 of 8 April 2003 which have not been removed by agreement of the parties, shall apply.

## 1 - Conditions applicables

**1.1.** Les conditions générales, précisées et énumérées ci-après, dénommées les « CONDITIONS », font partie intégrante du contrat de vente de carrelages et autres produits céramiques - ci-après dénommés le « PRODUIT » ou les « PRODUITS » - fabriqués par Margres - Gres Panaria Portugal, S.A., également dénommé le « FABRICANT ».

**1.2.** Sauf cas particuliers ou exceptionnels, où l'application de ces conditions générales est expressément modifiée par un accord écrit et signé par le FABRICANT, celles-ci représentent les conditions exclusives appliquées à cette vente. Si une ou plusieurs parties de ces CONDITIONS ou contrats, individuellement considérés et dont elles en font partie, sont de quelque manière que ce soit considérées comme nulles, invalides ou inapplicables pour des raisons de force majeure, les CONDITIONS générales ou particulières resteront valables dans leur ensemble, les conditions invalides étant remplacées par de nouvelles dispositions qui reproduiront, autant que possible, l'intention initiale des parties.

### 2 - Exécution du contrat de vente - Livraison des produits

**2.1.** Le contrat est conclu lorsque le vendeur ou l'acquéreur prend connaissance de l'acceptation écrite du contrat par l'autre partie.

**2.2.** Une commande non confirmée par écrit ne pourra en aucun cas être considérée comme non acceptée, sauf lorsqu'elle est exécutée par le FABRICANT via l'envoi ou la livraison des PRODUITS. La livraison partielle des PRODUITS commandés n'implique pas l'acceptation de l'intégralité de la commande, mais uniquement de la partie des PRODUITS effectivement livrée.

**2.3.** Sauf accord contraire préalable et exprès par écrit, la livraison des PRODUITS sera effectuée exclusivement Ex-works.

**2.4.** Sauf convention contraire expresse fixée par écrit, toutes les dates indiquées aux fins de la livraison seront considérées comme des dates approximatives.

### 3 - Caractéristiques des produits - Garantie - Réclamations

**3.1.** LES PRODUITS fabriqués par Margres - Gres Panaria Portugal, SA sont produits conformément aux normes européennes applicables. Le FABRICANT vend de préférence à des revendeurs professionnels, qui sont responsables de fournir des informations techniques correctes et appropriées aux utilisateurs finaux ou aux détaillants.

Le classement des PRODUITS est indiqué par le FABRICANT dans le matériel publicitaire et / ou dans les listes de prix. En conséquence, l'acquéreur doit utiliser les PRODUITS conformément aux spécifications du FABRICANT.

Afin de faciliter la suggestion d'utilisation et d'adapter la spécification standard à la production spécifique du FABRICANT, en ce qui concerne tous les produits, listes de prix ou catalogues, des symboles spécifiques sont ajoutés, indiquant l'utilisation recommandée de chaque produit par le FABRICANT.

**3.2.** Les différences de tonalité ou de chrominance qui peuvent être constables ne sont pas dues à des défauts du PRODUIT, mais si à une caractéristique spécifique du matériau céramique après avoir été soumis à une cuisson à haute température. La particularité de « résistance au gel » ne s'applique qu'aux produits spécifiquement garantis par le FABRICANT à cet effet, tel qu'indiqué dans son matériel publicitaire et /ou dans les listes de prix. Cette indication n'étant pas présente, les produits sont uniquement et exclusivement conçus pour être utilisés en intérieur ou, dans tous les cas, dans des lieux non exposés à des éléments atmosphériques qui altèrent les caractéristiques de résistance ou l'aspect d'origine du PRODUIT (par exemple : précipitations atmosphériques, soleil, humidité, basses températures, etc.).

**3.3.** Les carreaux aux faces polies peuvent changer d'apparence lorsqu'elles sont utilisées sur le sol des pièces avec accès à l'extérieur ou des espaces où une circulation piétonne régulière est prévue. Les carreaux polis peuvent également être glissants, surtout lorsqu'elles sont mouillées ou sous l'effet de l'humidité. Compte tenu de cette caractéristique, le FABRICANT déconseille d'utiliser ces PRODUITS dans les lieux publics. Pour les espaces avec une circulation intense de personnes, l'acquéreur doit acheter exclusivement les PRODUITS classés par le FABRICANT comme « PEI V » ou le « Grès cérame pleine masse », en particulier les PRODUITS que le FABRICANT recommande spécifiquement pour une utilisation dans les espaces publics.

**3.4.** La présentation des PRODUITS sur des dépliants ou tout autre matériel promotionnel du FABRICANT est purement illustrative et ne représente pas nécessairement le résultat esthétique final de la pose de ce produit spécifique.

**3.5.** Le FABRICANT garantit la bonne qualité et l'absence de défauts dans les PRODUITS fournis.

La garantie ne s'applique pas aux PRODUITS classés par le FABRICANT comme inférieurs à la qualité de 1er choix, ni aux stocks de produits dont la production est abandonnée, lorsqu'ils sont vendus en vrac ou indiqués comme lot spécial.

**3.6.** Le FABRICANT n'est pas responsable des défauts et / ou anomalies existant dans les PRODUITS pouvant découler du non-respect des spécifications techniques de ceux-ci, résultant d'une mauvaise utilisation des PRODUITS par les acheteurs et / ou des tiers agissant en leur nom. En particulier, le FABRICANT n'accepte aucune réclamation ou contestation liée aux situations décrites ci-dessus.

**3.7.** Les réclamations résultant de l'existence de défauts évidents ou cachés doivent être adressées par écrit au FABRICANT par l'acquéreur dans un délai de 60 jours à compter de la date de livraison des marchandises. La responsabilité du fabricant à l'égard des défauts inhérents aux produits livrés à l'acquéreur est expressément limitée à une période de 2 ans à compter de la date de réception des marchandises par l'acquéreur.

**3.8.** En général, la garantie ne s'applique qu'aux défauts constatés dans les produits qui n'ont pas encore été appliqués. En ce qui concerne les défauts détectés après la pose des PRODUITS, la garantie ne peut s'appliquer que lorsque le FABRICANT confirme que celle-ci a été réalisée conformément aux meilleures règles du métier (DIN 18352) et aux procédures décrites dans le manuel de pose et d'entretien du FABRICANT.

**3.9.** La garantie accordée par le FABRICANT est limitée au remplacement des produits défectueux par d'autres produits du même type sans défaut, majoré des frais de port. Le remboursement de tous autres frais et / ou dépenses et notamment des frais de démolition et de remplacement est expressément exclu. Dans tous les cas, la garantie du FABRICANT ne peut excéder cinq fois la valeur du matériau réclamé, jusqu'à un montant de 10 000 euros maximum.

**3.10.** Le FABRICANT ne peut pas être tenu responsable des réclamations dues à tout classement des matériaux céramiques effectué par des organismes de certification et de contrôle différents des organismes européens indiqués à l'article 3.1, sur la base des spécifications techniques qui ne correspondent pas à celles indiquées par le FABRICANT. Toute analyse technique spécialisée éventuelle, demandée par l'acquéreur, sera basée sur la correspondance des matériaux vendus avec les caractéristiques techniques indiquées par le FABRICANT, à présent applicables au Portugal.

### 4 - Prix et modalités de paiement

**4.1.** Les prix de vente des PRODUITS sont indiqués dans la liste de prix du FABRICANT, en vigueur à la date de confirmation de la commande. Pour les contrats de vente avec des livraisons séparées, le prix sera celui indiqué dans la liste de prix en vigueur à la date de chaque livraison, sauf si les parties contractantes en ont convenu autrement par écrit.

Pour les PRODUITS destinés aux marchés étrangers, le prix sera calculé, comme indiqué par le FABRICANT, dans la devise étrangère du pays de destination ou en Euros.

**4.2.** Sauf convention contraire expresse, les paiements seront effectués par virement bancaire, dans les 30 jours suivant la date de facturation. Tous les frais bancaires et de transfert sont à la charge de l'acquéreur. En cas de retard de paiement, le FABRICANT est en droit d'appliquer, sans mise en demeure adressée à l'acquéreur, et outre toutes autres pertes, un taux d'intérêt de retard et punitif équivalent au taux EURIBOR 6 mois majoré de 5%.

### 5 - Agents du fabricant

**5.1.** Les agents du FABRICANT doivent promouvoir la vente des PRODUITS, mais ne sont pas autorisés à agir pour le compte du FABRICANT, sauf s'ils obtiennent une autorisation expresse spécifique à cet effet.

**5.2.** Les commandes reçues par les agents n'engagent pas le FABRICANT. Elles doivent donc être expressément acceptées par écrit par le FABRICANT lui-même.

### 6 - Réserve de propriété

**6.1.** Les parties conviennent que la vente des PRODUITS est effectuée sous réserve de propriété par le FABRICANT jusqu'au paiement intégral du prix convenu, par l'acquéreur. Cependant, le risque de perte de la marchandise est transféré à l'acquéreur lors de la livraison des PRODUITS.

**6.2.** Dans le cas de ventes à l'étranger, lorsque les marchandises sont vendues et livrées à des tiers dans le cadre des activités commerciales normales de l'acquéreur et que le transfert de propriété des marchandises n'a pas encore eu lieu, le droit de réserve de propriété du FABRICANT reste valable à l'égard des tiers.

**6.3.** En cas de retard de paiement, le FABRICANT a le droit, sans avoir recours à aucune formalité, y compris à toute mise en demeure adressée à l'acquéreur, de retirer toutes les marchandises sous réserve de propriété et, lorsque légalement prévu, tous titres de crédit auprès de tiers. Le FABRICANT est en droit, qui lui est expressément réservé, de recourir à tous les moyens juridiques à sa disposition en vue de compenser les pertes qu'il a subies ou subira du fait du comportement fautif de l'acquéreur.

### 7 - Force majeure

**7.1.** Le FABRICANT ne sera pas responsable envers l'acquéreur de toute rupture de contrat, y compris la non-livraison ou la livraison en retard du PRODUIT, causée par des faits indépendants de sa volonté, tels que la non-livraison ou la livraison retardée des matériaux, de la part des fournisseurs, dysfonctionnements des locaux, grèves, faits de la nature, interruptions de l'approvisionnement en électricité, suspension ou difficultés de transport.

### 8 - Loi applicable - Jurisdiction compétente

**8.1.** Les dispositions fixées au décret-loi n° 67/2003, du 8 avril 2003, qui n'aient pas été rejetées par accord entre les parties, s'appliquent dans l'interprétation, l'intégration ou la rectification des présentes conditions.

index

colour map

collections

linea collections

useful information

calibers

certification

general sales conditions

important notes

magres green

laying suggestions

outdoor extra thick

package

pr()tect

symbols

technical information

think zero



# allgemeine verkaufsbedingungen

**1 - Anwendbarkeit der Bedingungen**

**1.1.** Die nachstehend aufgeführten und definierten allgemeinen Bedingungen - im Folgenden als "BEDINGUNGEN" bezeichnet - sind integraler Bestandteil des Vertrags für den Kauf und Verkauf von Mosaikfliesen und anderen keramischen Produkten - im Folgenden als "PRODUKT" oder "PRODUKTE" bezeichnet - hergestellt von Margres - Gres Panaria Portugal, S.A., auch als "HERSTELLER" bezeichnet.

**1.2.** Außer in besonderen oder außergewöhnlichen Fällen, in denen die Anwendung dieser Bedingungen ausdrücklich durch eine schriftliche Vereinbarung geändert und vom HERSTELLER unterzeichnet wurden, stellen sie die ausschließlichen Bedingungen dar, die in Verbindung mit einem solchen Verkauf geltend gemacht werden können. Wenn ein oder mehrere Teile dieser BEDINGUNGEN oder Verträge einzeln betrachtet werden und Bestandteil dieser sind, aufgrund höherer Gewalt in irgendeiner Weise als nichtig, ungültig oder nicht durchsetzbar gelten, bleiben die allgemeinen oder besonderen BEDINGUNGEN als Ganzes gültig. Die ungültigen Bedingungen werden durch neue Bestimmungen ersetzt, die so weit wie möglich die ursprüngliche Absicht der Parteien wiedergeben.

**2 - Ausführung des Kaufvertrags - Lieferung von Produkten**

**2.1.** Der Vertrag ist abgeschlossen, wenn der vorschlagenden Partei oder dem Käufer die schriftliche Annahme durch die Gegenpartei bekannt ist.

**2.2.** Eine Bestellung, die nicht schriftlich bestätigt wurde, kann unter keinen Umständen als nicht angenommen betrachtet werden, es sei denn, sie wurde vom HERSTELLER durch Versand oder Lieferung der PRODUKTE ausgeführt. Die Teillieferung der bestellten PRODUKTE bedeutet nicht die Annahme der gesamten Bestellung, sondern nur des Teils der PRODUKTE, der tatsächlich geliefert worden ist.

**2.3.** Sofern nicht ausdrücklich schriftlich und im Voraus anders vereinbart, erfolgt die Lieferung der PRODUKTE ausschließlich ab Werk.

**2.4.** Sofern nicht ausdrücklich anders vereinbart, gelten alle für Lieferzwecke angegebenen Daten als ungefähre Daten.

**3 - Eigenschaften der Produkte - Garantie - Reklamationen**

**3.1.** Die von Margres - Gres Panaria Portugal, S.A. hergestellten PRODUKTE werden in Übereinstimmung mit den geltenden europäischen Normen hergestellt. Der HERSTELLER verkauft vorzugsweise an professionelle Wiederverkäufer. Diese sind für die Bereitstellung korrekter und angemessener technischer Informationen für Endbenutzer oder Einzelhändler verantwortlich.

Die Klassifizierung der PRODUKTE wird vom HERSTELLER auf Werbematerial und/oder Preislisten angegeben. Folglich muss der Käufer die PRODUKTE in Übereinstimmung mit den Spezifikationen des HERSTELLERS verwenden.

Um den Verwendungsvorschlag zu erleichtern und die Standardspezifikation an die spezifische Produktion des HERSTELLERS anzupassen, sind auf allen Produkten, Preislisten oder Katalogen spezifische Symbole angebracht, die die vom HERSTELLER empfohlene Verwendung für jedes Produkt angeben.

**3.2.** Die Unterschiede in Tonalität oder Farbe , wenn überhaupt, sind nicht auf Fehler im PRODUKT zurückzuführen, sondern eine spezifische Eigenschaft des keramischen Materials, das bei hohen Temperaturen gebrannt wurde. Die besondere Eigenschaft der "Frostbeständigkeit" gilt nur für Produkte, für die der HERSTELLER ausdrücklich in seinen Werbematerialien und/oder in den Preislisten diese Garantie gibt. Fehlt diese Angabe, werden die Produkte nur und ausschließlich für die Verwendung in Innenräumen oder jedenfalls für die Verwendung an Orten betrachtet, die nicht atmosphärischen Elementen ausgesetzt sind, die die Haltbarkeitseigenschaften oder das ursprüngliche Aussehen des PRODUKTES verändern (z. B. atmosphärischer Niederschlag, Sonne, Feuchtigkeit, niedrige Temperaturen, etc.).

**3.3.** Die Fliesen mit den polierten Oberflächen können ihr Aussehen verändern, wenn sie als Bodenbelag in Räumen verwendet werden, die von außen zugänglich sind, oder in Räumen, in denen intensiver Fußgängerverkehr erwartet wird. Polierte Fliesen können auch rutschig sein, insbesondere wenn sie nass oder feucht sind. Aus diesem Grund rät der HERSTELLER davon ab, diese PRODUKTE an öffentlichen Orten zu verwenden. Für Orte, an denen intensiver Fußgängerverkehr zu erwarten ist, sollte der Käufer nur PRODUKTE kaufen, die vom HERSTELLER als "PEI V" oder "Vollmassiges Feinsteinzeug" klassifiziert werden, insbesondere solche PRODUKTE, die der HERSTELLER speziell für die Verwendung an öffentlichen Orten empfiehlt.

**3.4.** Die Präsentationen der PRODUKTE in Broschüren oder in anderem Werbematerial des HERSTELLERS dienen lediglich der Veranschaulichung und stellen nicht unbedingt das ästhetische Endergebnis dar, das sich aus der Installation dieses spezifischen Produkts ergibt.

**3.5.** Der HERSTELLER garantiert die gute Qualität und die Mängelfreiheit der gelieferten PRODUKTE.

Die Garantie gilt nicht für PRODUKTE, die vom HERSTELLER als minderwertig gegenüber der Qualität der 1. Wahl eingestuft werden, oder für die Lagerbestände von Produkten, die eingestellt wurden, wenn sie lose verkauft oder als Sonderposten angegeben werden.

**3.6.** Der HERSTELLER haftet nicht für Mängel und/oder Anomalien der PRODUKTE, die sich nicht aus den technischen Spezifikationen derselben ableiten, sondern aus der unsachgemäßen Verwendung der PRODUKTE durch die Käufer und/oder in ihrem Namen handelnde Dritte entstehen. Insbesondere akzeptiert der HERSTELLER keine Beschwerden oder Streitigkeiten im Zusammenhang mit den oben beschriebenen Situationen.

**3.7.** Ansprüche, die sich aus dem Vorhandensein von patentierten oder versteckten Mängeln ergeben, müssen vom Käufer innerhalb von 60 Tagen nach Lieferung der Ware schriftlich dem HERSTELLER bekannt gemacht werden. Die Haftung des Herstellers für Mängel an den an den Käufer gelieferten Produkten ist ausdrücklich auf einen Zeitraum von 2 Jahren ab dem Datum des Erhalts der Ware durch den Käufer beschränkt.

**3.8.** Im Allgemeinen gilt die Garantie nur für Mängel an Produkten, die noch nicht angewendet wurden. Für Mängel, die nach der Anwendung der PRODUKTE festgestellt werden, kann die Garantie nur dann gelten, wenn der HERSTELLER bestätigt hat, dass die Installation des PRODUKTES nach den besten Praktiken (DIN 18352) sowie in Übereinstimmung mit den im Anwendungs- und Wartungshandbuch des HERSTELLERS beschriebenen Verfahren durchgeführt wurde.

**3.9.** Die vom HERSTELLER gewährte Garantie beschränkt sich auf den Ersatz defekter Produkte durch andere Produkte desselben Typs ohne Mängel, zuzüglich Transportkosten. Die Erstattung sonstiger Kosten und/oder Aufwendungen, insbesondere Abbruch- und Umzugskosten, ist ausdrücklich ausgeschlossen. In jedem Fall darf die Garantie des HERSTELLERS den fünffachen Wert des beanspruchten Materials bis zu einem Höchstbetrag von 10.000 Euro nicht überschreiten.

**3.10.** Der HERSTELLER ist nicht verantwortlich für Ansprüche aufgrund einer Klassifizierung von keramischen Materialien, die von anderen als den in Artikel 3.1 angegebenen europäischen Zertifizierungs- und Kontrollorganen auf der Grundlage technischer Spezifikationen vorgenommen wurden, die nicht den vom HERSTELLER angegebenen entsprechen. Jede spezialisierte technische Analyse, die vom Käufer angefordert wird, basiert auf der Übereinstimmung der verkauften Materialien mit den vom HERSTELLER angegebenen technischen Eigenschaften, die zu diesem Zeitpunkt in Portugal gelten.

**4 - Preise und Zahlungsbedingungen**

**4.1.** Die Verkaufspreise der PRODUKTE sind diejenigen, die in der am Datum der Auftragsbestätigung gültigen Preisliste des HERSTELLERS angegeben sind. Bei Kaufverträgen mit getrennten Lieferungen gilt der Preis, der in der am Tag der jeweiligen Lieferung gültigen Preisliste angegeben ist, sofern die Vertragsparteien nichts anderes schriftlich vereinbart haben.

Für PRODUKTE, die für ausländische Märkte bestimmt sind, wird der Preis nach Angaben des HERSTELLERS in der Fremdwährung des Bestimmungslandes oder in Euro berechnet.

**4.2.** Sofern nicht ausdrücklich anders vereinbart, sind Zahlungen per Banküberweisung innerhalb von 30 Tagen ab Rechnungsdatum zu leisten. Alle Bank- und Überweisungsgebühren gehen zu Lasten des Käufers. Bei Zahlungsverzug ist der HERSTELLER berechtigt, zusammen mit allen anderen Verlusten und ohne vorherige Benachrichtigung des Käufers, einen Verzugs- und Strafzinssatz in Höhe des EURIBOR sechs Monate plus 5% anzuwenden.

**5 - Vertreter des Herstellers**

**5.1.** Die Vertreter des HERSTELLERS werben für den Verkauf der PRODUKTE und sind nicht befugt, im Namen und im Auftrag des HERSTELLERS zu handeln, es sei denn, sie erhalten dafür eine ausdrückliche Sondergenehmigung.

**5.2.** Aufträge, die von Vertretern entgegengenommen werden, sind für den HERSTELLER nicht bindend und müssen daher vom HERSTELLER selbst ausdrücklich und schriftlich angenommen werden.

**6 – Eigentumsvorbehalt**

**6.1.** Es wird zwischen den Parteien vereinbart, dass der Verkauf der PRODUKTE unter Eigentumsvorbehalt seitens des HERSTELLERS erfolgt, bis der Käufer den vereinbarten Preis vollständig bezahlt hat. Das Verlustrisiko der Waren geht jedoch mit der Lieferung der PRODUKTE auf den Käufer über.

**6.2.** Im Falle von Verkäufen ins Ausland bleibt der Eigentumsvorbehalt des HERSTELLERS gegenüber dem Dritten bestehen, wenn die Waren im Rahmen der normalen Geschäftstätigkeit des Käufers an einen Dritten verkauft und geliefert werden und das Eigentumsrecht an den Waren noch nicht übertragen wurde.

**6.3.** Bei Zahlungsverzug hat der HERSTELLER das Recht, ohne jegliche Formalität, einschließlich irgendwelcher vorherigen Benachrichtigung des Käufers, alle unter Eigentumsvorbehalt stehenden Waren und, falls gesetzlich erlaubt, alle Kreditittel vor Dritten einzuziehen, wobei dem HERSTELLER ausdrücklich das Recht vorbehalten bleibt, alle ihm zur Verfügung stehenden rechtlichen Mittel einzusetzen, um den Schaden, den er aufgrund des säumigen Verhaltens des Käufers erlitten hat oder erleiden wird, wieder gutzumachen.

**7 – Fall von höherer Gewalt**

**7.1.** Der HERSTELLER haftet dem Käufer gegenüber nicht für Vertragsverletzungen, einschließlich der Nichtlieferung oder verspäteten Lieferung des PRODUKTES, die durch Tatsachen verursacht werden, die sich seiner Kontrolle entziehen, wie z.B. Nichtlieferung oder verspätete Lieferung von Materialien durch Lieferanten, Betriebsstörungen, Streiks, Naturkatastrophen, Unterbrechungen der Stromversorgung, Aussetzung oder Transportschwierigkeiten.

**8 – Anwendbares Recht - Zuständiges Gericht**

**8.1.** Bei der Auslegung, Umsetzung oder Berichtigung dieser Bedingungen gelten die im Gesetzesdekret Nr. 67/2003 vom 8. April 2003 enthaltenen Bestimmungen, wenn sie nicht durch Vereinbarung der Parteien aufgehoben wurden.

**1 - Aplicabilidade das Condições**

**1.1.** As condições gerais em seguida elencadas e especificadas - de ora em diante denominadas "CONDIÇÕES" -, constituem parte integrante do contrato de compra e venda de mosaicos

e outros produtos cerâmicos - de ora em diante designados como o "PRODUTO" ou os "PRODUTOS" - fabricados pela Margres - Gres Panaria Portugal, S.A., também designado como o "FABRICANTE".

**1.2.** Salvo casos específicos ou excepcionais, em que a aplicação destas condições seja expressamente alterada através de acordo escrito e assinado pelo FABRICANTE, elas representam as condições exclusivas aplicadas a essa venda. Se uma ou mais partes das presentes CONDIÇÕES ou contratos, individualmente considerados e dos quais elas façam parte, forem alguma forma julgadas nulas, inválidas ou inaplicáveis por razões de força maior, as CONDIÇÕES gerais ou particulares permanecerão válidas no seu conjunto, sendo que as condições inválidas serão substituídas por novas disposições que reproduzirão, tanto quanto possível, a intenção original das partes.

**2 - Execução do Contrato de Venda - Entrega dos Produtos**

**2.1.** O contrato é celebrado quando a parte proponente ou o comprador tiver conhecimento da aceitação escrita do mesmo pela contraparte.

**2.2.** Uma encomenda que não tiver sido confirmada por escrito não pode, em nenhuma circunstância, ser considerada como não sido aceite, excepto se tiver sido executada pelo FABRICANTE através do envio ou da entrega dos PRODUTOS. A entrega parcial dos PRODUTOS encomendados não implica a aceitação da totalidade da encomenda, mas apenas da parte dos PRODUTOS que tenham sido efectivamente entregue.

**2.3.** Excepto se o contrário for prévia e expressamente acordado por escrito, a entrega dos PRODUTOS será efectuada exclusivamente no território de Portugal Continental e na condição de que seja possível e permitido o acesso ao local da entrega de veículo pesado com semi-reboque de 24 (vinte e quatro) toneladas de peso bruto.

**2.4.** Excepto se o contrário for expressamente acordado por escrito, a entrega dos PRODUTOS apenas será efectuada em obra se a encomenda a entregar for superior a 100m2 (cem metros quadrados).

**2.5.** Salvo acordo expresso em contrário, todas as datas que forem indicadas para efeitos de entrega, serão consideradas como datas aproximadas.

**3 - Características dos Produtos - Garantia - Reclamações**

A classificação dos PRODUTOS fabricados pela Margres - Gres Panaria Portugal, S.A. são produzidos em conformidade com as normas europeias aplicáveis. O FABRICANTE vende preferencialmente a revendedores profissionais, sendo estes os responsáveis por prestarem informações técnicas correctas e adequadas aos utilizadores finais ou aos retalhistas.

A classificação dos PRODUTOS é indicada pelo FABRICANTE no material publicitário e/ ou nas tabelas de preços. Em consequência, o comprador deverá usar os PRODUTOS em conformidade com as especificações do FABRICANTE.

Para facilitar a sugestão de uso e adaptar a especificação standard à produção específica do FABRICANTE, sobre todos os produtos, listas de preços ou catálogos existem símbolos específicos que indicam a utilização aconselhada para cada produto por parte do FABRICANTE.

**3.2.** As diferenças de tonalidade ou crominância eventualmente constáveis não decorrem de defeitos do PRODUTO, sendo sim uma característica específica do material cerâmico que foi submetido a cozedura a altas temperaturas. A característica especial de "resistência à congelação" apenas se aplica aos produtos que o FABRICANTE tenha especificamente garantido para esse efeito através de uma indicação expressa no seu material publicitário e/ou nas tabelas de preços. No caso de inexistência desta indicação, os produtos serão considerados única e exclusivamente para utilização em interior ou, em qualquer caso, para utilização em locais que não estejam expostos a elementos atmosféricos que alterem as características de resistência ou aparência original do PRODUTO (ex.: precipitação atmosférica, sol, humidade, temperaturas baixas, etc.).

**3.3.** Os mosaicos com as faces polidas podem alterar o seu aspecto quando utilizados no pavimento de divisões que tenham acesso a partir do exterior, ou divisões onde se preveja intensa circulação pedonal. Os mosaicos polidos podem também ser escorregadios, especialmente quando estiverem molhados ou sob o efeito de humidade. Atento a este motivo o FABRICANTE desaconselha

a utilização destes PRODUTOS em locais públicos. Para os locais de circulação intensa de pessoas, o comprador apenas deverá adquirir PRODUTOS classificados pelo FABRICANTE como "PEI V" ou "Grés Porcelânico Toda-a-Massa", em particular os PRODUTOS que o FABRICANTE recomendar especificamente para utilização em locais públicos.

**3.4.** As apresentações dos PRODUTOS em folhetos ou em qualquer outro material promocional do FABRICANTE são meramente ilustrativos e não representam necessariamente o resultado final estético decorrente da instalação desse produto específico.

**3.5.** O FABRICANTE garante a boa qualidade e a ausência de defeitos nos PRODUTOS fornecidos.

A garantia não se aplica aos PRODUTOS classificados pelo FABRICANTE como inferiores à qualidade de 1ª escolha, ou aos stocks de produtos que tenham sido descontinuados, quando forem vendidos a granel ou indicados como lote especial.

**3.6.** O FABRICANTE não é responsável por quaisquer defeitos e/ou anomalias existentes nos PRODUTOS que não derivem das especificações técnicas dos mesmos, mas antes decorram de uma utilização inadequadas dos PRODUTOS por parte dos adquirentes e/ou

de terceiros que actuem em seu nome. Em particular, o FABRICANTE não aceita quaisquer reclamações ou litígios ligados às situações anteriormente descritas.

**3.7.** As reclamações decorrentes da existência de defeitos patentes ou ocultos terão de ser efectuados por escrito ao FABRICANTE pelo comprador no prazo de 60 dias a contar da data de entrega das mercadorias. A responsabilidade do Fabricante por defeitos inerentes aos produtos entregues ao comprador fica expressamente limitado ao prazo de 2 anos a contar da data de recepção do bem pelo comprador.

**3.8.** Em geral, a garantia apenas se aplica aos defeitos detectados em produtos que ainda não foram aplicados. Relativamente aos defeitos detectados após os PRODUTOS terem sido aplicados, a garantia apenas pode aplicar-se se o FABRICANTE tiver confirmado que a colocação do PRODUTO foi efectuada em conformidade com as melhores regras da actividade (DIN 18352), bem como de acordo com os procedimentos descritos no manual de aplicação e manutenção do FABRICANTE.

**3.9.** A garantia concedida pelo FABRICANTE limita-se à substituição dos produtos defeituosos por outros produtos do mesmo tipo sem defeito, acrescida das despesas de transporte. É expressamente excluído o reembolso de quaisquer outros custos e/ ou despesas e em particular os custos de demolição e recolocação. Em qualquer caso, a garantia do FABRICANTE não pode ultrapassar em cinco vezes o valor do material reclamado, até um valor máximo de 10.000 Euros.

**3.10.** O FABRICANTE não é responsável por quaisquer reclamações devidas a uma classificação de materiais cerâmicos efectuada por organismos de certificação e controlo e diferentes dos europeus indicados no artigo 3.1, com base em especificações técnicas que não correspondam às indicadas pelo FABRICANTE. Qualquer eventual análise técnica especializada solicitada pelo comprador será baseada na correspondência dos materiais vendidos com as características técnicas indicadas pelo FABRICANTE, nesse momento em vigor em Portugal.

**4 - Preços e Condições de Pagamento**

**4.1.** Os preços de venda dos PRODUTOS são os indicados na tabela de preços do FABRICANTE vigente à data de confirmação da encomenda. Para contratos de venda com entregas separadas, o preço será o constante da tabela de preços em vigor à data de cada uma das entregas, excepto se as partes contraentes dispuserem por escrito em sentido diverso.

Para os PRODUTOS destinados a mercados estrangeiros o preço será calculado, por indicação do FABRICANTE, na moeda estrangeira do país de destino ou em Euros.

**4.2.** Excepto se o contrário for expressamente acordado, os pagamentos serão efectuados através de transferência bancária, no prazo de 30 dias a contar da data da factura. Todas as despesas bancárias e de transferência correm por conta do comprador. No caso de atraso na realização do pagamento o FABRICANTE, juntamente com quaisquer outros prejuízos, terá direito, sem necessidade de aviso prévio ao comprador, a aplicar uma taxa de juros de mora e punitivos equivalente à taxa EURIBOR a 6 meses acrescida de 5%.

**5 - Agentes do Fabricante**

**5.1.** Os agentes do FABRICANTE promovem a venda dos PRODUTOS e não estão autorizados a agir em nome e por conta do FABRICANTE, excepto no caso de obtêrem autorização específica expressa para o efeito.

**5.2.** As encomendas recebidas pelos agentes não vinculam o FABRICANTE e deverão, portanto, ser expressamente aceites por escrito pelo próprio FABRICANTE.

**6 – Reserva de Propriedade**

**6.1.** É acordado entre as partes que a venda dos PRODUTOS seja efectuada com reserva de propriedade por parte do FABRICANTE até que o pagamento integral do preço acordado esteja integralmente saldado por parte do comprador. No entanto, o risco de perda das mercadorias é transferido para o comprador no momento da entrega dos PRODUTOS.

**6.2.** No caso de vendas para países estrangeiros, quando as mercadorias são vendidas e entregues a terceiros no âmbito das actividades comerciais normais do Comprador e a propriedade das mercadorias ainda não tiver sido transferida, o direito de reserva de propriedade do FABRICANTE permanece válido perante terceiros.

**6.3.** No caso de atrasos no pagamento o FABRICANTE tem o direito, sem necessidade de recorrer a qualquer formalidade, incluindo qualquer aviso prévio ao comprador, a recolher todas as mercadorias sujeitas a reserva de propriedade e, se legalmente consagrado, todos os títulos de crédito perante terceiros, ficando expressamente reservado o direito do FABRICANTE recorrer a todos os meios legais ao seu dispor tendo em vista o ressarcimento dos prejuízos que tiver sofrido ou que vier a sofrer em consequência da conduta inadimplente do Comprador.

**7 – Caso de Força Maior**

**7.1.** O FABRICANTE não será responsável perante o comprador por qualquer incumprimento do contrato, incluindo a falta de entrega ou a entrega com atraso do PRODUTO, causada por factos que estão fora do seu controlo, como por exemplo, a não entrega ou entrega com atraso de materiais por parte de fornecedores, avarias nas instalações, greves, factos da natureza, interrupções no fornecimento de energia eléctrica, suspensão ou dificuldades de transporte.

**8 – Legislação Aplicável - Foro Competente**

**8.1.** Na interpretação, integração ou rectificação das presentes condições vigorarão as disposições constantes do Decreto-Lei N.º 67/2003, de 8 de Abril, que não tenham sido afastadas por acordo das partes.

index

colour map

collections

linea collections

useful information

calibers

certification

general sales conditions

important notes

magres green

laying suggestions

outdoor extra thick

package

pr()tect

symbols

technical information

think zero



# condiciones generales de venta

—

## condiciones generales de venta

**1 - Aplicabilidad de las Condiciones**

**1.1.** Las condiciones generales enumeradas y especificadas a continuación –en adelante denominadas “CONDICIONES” -, constituyen parte integrante del contrato de compraventa de baldosas y de otros productos cerámicos – en adelante designados como el “PRODUCTO” o los “PRODUCTOS” - fabricados por Margres - Gres Panaria Portugal, S.A., también designado como el “FABRICANTE”.

**1.2.** Salvo casos específicos o excepcionales, en los que la aplicación de estas condiciones sea expresamente alterada a través de un acuerdo por escrito y firmado por el FABRICANTE, las mismas representan las condiciones exclusivas aplicadas a esta venta. Si una o más partes de las presentes CONDICIONES o contratos, individualmente considerados y de los cuales formen parte, fuesen consideradas nulas, inválidas o inaplicables, por razones de fuerza mayor, las CONDICIONES generales o particulares permanecerán válidas en su conjunto, sustituyéndose las condiciones inválidas por nuevas disposiciones que reproducirán, lo mejor posible, la intención original de las partes.

**2 – Ejecución del Contrato de Venta - Entrega de los Productos**

**2.1.** El contrato se celebra cuando la parte proponente o el comprador tenga conocimiento de la aceptación escrita del mismo por la contraparte.

**2.2.** Un pedido que no haya sido confirmado por escrito no puede ser considerado, bajo ninguna circunstancia, como no habiendo sido aceptado, excepto cuando haya sido ejecutado por el FABRICANTE, a través del envío o de la entrega de los PRODUCTOS. La entrega parcial de los PRODUCTOS del pedido no implica la aceptación de la totalidad del pedido, sino tan solo la parte de los PRODUCTOS que efectivamente han sido entregados.

**2.3.** Excepto cuando, previa y expresamente se haya acordado lo contrario, por escrito, la entrega de los PRODUCTOS se efectuará exclusivamente Exworks.

**2.4.** Salvo acuerdo expreso en contrario, todas las fechas que se indiquen a efectos de entrega serán consideradas como fechas aproximadas.

**3 - Características de los Productos - Garantía - Reclamaciones**

**3.1.** Los PRODUCTOS fabricados por Margres - Gres Panaria Portugal, S.A. se elaboran de acuerdo con las normas europeas aplicables. El FABRICANTE vende, de preferencia, a revendedores profesionales, que son responsables de prestar las informaciones técnicas correctas y adecuadas a los utilizadores finales o a los minoristas.

El FABRICANTE indicará la clasificación de los PRODUCTOS en el material publicitario y/o en las listas de precios. Así, el comprador deberá usar los PRODUCTOS conforme las especificaciones del FABRICANTE.

Para facilitar la sugerencia de utilización y adaptar la especificación estándar a la producción específica del FABRICANTE, existen, en todos los productos, listas de precios o catálogos, símbolos específicos que indican la utilización aconsejada para cada producto, por parte del FABRICANTE.

**3.2.** Las diferencias de tonalidad o crominancia que eventualmente puedan constar, no se deben a defectos del PRODUCTO, sino que es una característica específica del material cerámico que ha sido sometido a cocción, a altas temperaturas. La característica especial de “resistencia a la congelación” apenas se aplica a los productos garantizados como tales por el FABRICANTE, a través de una indicación expresada en su material publicitario y/o en las listas de precios. Cuando no exista esta indicación, los productos serán considerados única y exclusivamente para utilización en interior o, en cualquier caso, para ser utilizados en lugares que no se encuentren expuestos a los elementos atmosféricos que puedan alterar las características de resistencia o apariencia original del PRODUCTO (ej.: precipitación atmosférica, sol, humedad, bajas temperaturas, etc.).

**3.3.** Las baldosas de caras pulidas pueden sufrir alteraciones de aspecto cuando se utilicen como pavimento de estancias cuyo acceso se realice a partir del exterior, o estancias en las que se prevea una intensa circulación peatonal. Las baldosas pulidas también pueden resultar escurridizas, especialmente cuando están mojadas o por efecto de la humedad. Considerando este último aspecto, el FABRICANTE no recomienda utilizar estos PRODUCTOS en locales públicos. Para aquellos lugares con una circulación intensa de personas, el comprador apenas deberá adquirir PRODUCTOS clasificados por el FABRICANTE como “PEI V” o “Gres Porcelánico Todo Masa”, en particular los PRODUCTOS recomendados por el FABRICANTE específicamente para ser utilizados en lugares públicos.

**3.4.** Las presentaciones de los PRODUCTOS en folletos o en cualquier otro material promocional del FABRICANTE son meramente ilustrativos y, no tienen por qué representar el resultado final estético tras la instalación de ese producto específico.

**3.5.** El FABRICANTE garantiza la buena calidad y la ausencia de defectos en los PRODUCTOS suministrados.

La garantía no se aplica a los PRODUCTOS clasificados por el FABRICANTE como inferiores a los de 1ra calidad, o a los stocks de productos discontinuados, cuando se vendan a granel o estén indicados como lote especial.

**3.6.** El FABRICANTE no se responsabiliza por cualquier defectos y/o anomalías existentes en los PRODUCTOS que no resulten de las especificaciones técnicas de los mismos, sino que se deban a un uso inadecuado de los PRODUCTOS por parte de los adquirentes y/o de terceros que actúen en su nombre. En concreto, el FABRICANTE no acepta ninguna reclamación o litigio relacionada con las situaciones anteriormente descritas.

**3.7.** Las reclamaciones resultantes de la existencia de defectos patentes u ocultos tendrán que ser efectuadas por el comprador, por escrito, dirigidas al FABRICANTE, en un plazo de 60 días a partir de la fecha de entrega de las mercancías. La responsabilidad

del Fabricante por defectos inherentes a los productos entregados al comprador queda expresamente limitada al plazo de 2 años a partir de la fecha de recepción de los bienes por parte del comprador.

**3.8.** En general, la garantía apenas se aplica a los defectos detectados en productos que aún no han sido aplicados. En relación a los defectos detectados tras la aplicación de los PRODUCTOS, la garantía apenas se podrá aplicar si el FABRICANTE hubiera confirmado que la instalación del PRODUCTO fue realizada de acuerdo con las mejores reglas de la actividad (DIN 18352), así como conforme a los procedimientos descritos en el manual de aplicación y mantenimiento del FABRICANTE.

**3.9.** La garantía concedida por el FABRICANTE se limita a la sustitución de los productos defectuosos por otros productos del mismo tipo, sin defecto, más gastos de transporte. Queda expresamente excluido el reembolso de cualquier otros costes y/o gastos, y en particular los costes con demoliciones y reinstalaciones. De cualquier manera, la garantía del FABRICANTE no podrá superar cinco veces el valor del material reclamado, hasta un valor máximo de 10.000 Euros.

**3.10.** El FABRICANTE no se responsabiliza de ninguna reclamación causada por una clasificación de materiales cerámicos efectuada por organismos de certificación y control diferentes de los europeos, indicados en el artículo 3.1, con base en especificaciones técnicas que no correspondan a las indicadas por el FABRICANTE. Cualquier eventual análisis técnico especializado, solicitado por el comprador se basará en la correspondencia de los materiales vendidos con las características técnicas indicadas por el FABRICANTE, vigentes en Portugal en ese momento.

**4 – Precios y condiciones de pago**

**4.1.** Los precios de venta de los PRODUCTOS están indicados en la lista de precios del FABRICANTE, vigente en la fecha de confirmación del pedido. Para contratos de venta con entregas separadas, el precio será el que conste en la lista de precios en vigor en la fecha de cada una de las entregas, excepto cuando las partes contratantes dispongan, por escrito, lo contrario.

Para los PRODUCTOS destinados a mercados extranjeros, el precio se calculará, por indicación del FABRICANTE, en la moneda extranjera del país de destino o en euros.

**4.2.** Excepto cuando se acuerde expresamente lo contrario, los pagos se efectuarán a través de transferencia bancaria, en un plazo de 30 días a partir de la fecha de la factura. Todos los gastos bancarios y de transferencias correrán por cuenta del comprador. En caso de atraso en la realización del pago, el FABRICANTE, además de cualquier otros perjuicios, sin necesidad de aviso previo al comprador, tendrá derecho a aplicar un tipo de interés de demora y punitivos equivalente al EURIBOR a 6 meses, más un 5%.

**5 - Agentes del Fabricante**

**5.1.** Los agentes del FABRICANTE promueven la venta de los PRODUCTOS y no están autorizados a actuar en nombre y por cuenta del FABRICANTE, excepto cuando obtengan autorización específica expresa al efecto.

**5.2.** Los pedidos recibidos por los agentes no vinculan al FABRICANTE y, por lo tanto, deberán ser expresamente aceptados, por escrito, por el propio FABRICANTE.

**6 – Reserva de Propiedad**

**6.1.** Se acuerda entre las partes que la venta de los PRODUCTOS se efectuará con reserva de propiedad por parte del FABRICANTE, hasta que el pago integral del precio acordado haya sido completamente saldado por parte del comprador. No obstante, el riesgo de pérdida de las mercancías será transferido al comprador en el acto de la entrega de los PRODUCTOS.

**6.2.** En caso de ventas a países extranjeros, cuando las mercancías son vendidas y entregadas a terceros, en el ámbito de las actividades comerciales normales del Comprador y la propiedad de las mismas aún no haya sido transferida, el derecho de reserva de propiedad del FABRICANTE permanece válido ante terceros.

**6.3.** En caso de atraso en el pago, el FABRICANTE, sin necesidad de recurrir a cualquier formalidad, incluyendo cualquier aviso previo al comprador, tiene derecho a recoger todas las mercancías sujetas a reserva de propiedad y, si estuviera legalmente consagrado, todos los títulos de crédito ante terceros, quedando reservado expresamente el derecho del FABRICANTE de recurrir a todos los medios legales a su disposición para resarcirse de los perjuicios que haya sufrido o que llegue a sufrir como consecuencia de la conducta incumplidora del Comprador.

**7 – Caso de fuerza mayor**

**7.1.** El FABRICANTE no se responsabilizará, ante el comprador, por cualquier incumplimiento del contrato, incluyendo la falta de entrega o la entrega con atraso del PRODUCTO, causada por situaciones que no están bajo su control, como por ejemplo, la no entrega o entrega con atraso de materiales por parte de proveedores, averías en las instalaciones, huelgas, fenómenos de la naturaleza, interrupciones en el suministro de la energía eléctrica, suspensión o dificultad en el transporte.

**8 – Legislación aplicable - Fuero competente**

**8.1.** Para la interpretación, integración o rectificación de las presentes condiciones estarán vigentes las disposiciones constantes en el Decreto Ley Nº 67/2003, de 8 de abril, que no hayan sido rechazadas por acuerdo de las partes.

**1 – Aplicabilidad de los Condiciones**

**1.1.** Perечисленные и указанные ниже общие условия, в дальнейшем именуемые «УСЛОВИЯ», составляют неотъемлемую часть договора купли-продажи мозаики и других керамических изделий, именуемых в дальнейшем «ПРОДУКТ» или «ПРОДУКЦИЯ», производства Margres - Gres Panaria Portugal, SA, также известного как “ПРОИЗВОДИТЕЛЬ”.

**1.2.** За исключением особых или исключительных случаев, когда применение этих условий конкретно изменятся посредством письменного соглашения, составленного и подписанного ПРОИЗВОДИТЕЛЕМ, они представляют собой исключительные условия, применяемые к данной продаже. Если одна или несколько частей настоящих УСЛОВИЙ или договоров, рассматриваемых индивидуально и являющихся неотъемлемой их частью, каким-либо образом считается недействительной или непримимой по причинам форс-мажора, общие или частные УСЛОВИЯ, в целом, будут оставаться в силе, а недействительные условия будут заменены новыми положениями, которые будут максимально воспроизводить первоначальные намерения сторон.

**2 – Оформление договора купли-продажи – Доставка товара**

**2.1.** Контракт считается заключенным, когда предлагающая сторона или покупатель узнает о письменном принятии контракта контрагентом.

**2.2.** Заказ, не подтвержденный в письменной форме, ни при каких обстоятельствах не может считаться принятым, если он не был выполнен ПРОИЗВОДИТЕЛЕМ путем отправки или доставки ПРОДУКЦИИ. Частичная доставка заказанных ТОВАРОВ не подразумевает принятие всего заказа, а только той части ТОВАРОВ, которая была фактически доставлена.

**2.3.** За исключением случаев, когда иное явно оговорено в письменной форме, доставка ПРОДУКЦИИ будет производиться исключительно на условиях Ex-works (франко-завод).

**2.4.** Если прямо не согласовано иное, все даты, указанные для целей доставки, будут рассматриваться как приблизительные.

**3 – Характеристика продукции - Гарантия - Претензии**

**3.1.** ПРОДУКЦИЯ, производимая Margres - Gres Panaria Portugal, S.A., производится в соответствии с действующими европейскими стандартами. ПРОИЗВОДИТЕЛЬ предпочитает продавать свою продукцию профессиональным посредникам, которые несут ответственность за предоставление правильной и соответствующей технической информации конечным пользователям, или продавцам розничной торговли.

Классификация ТОВАРОВ указывается ПРОИЗВОДИТЕЛЕМ в рекламных материалах и/или в прайс-листах. Следовательно, покупатель должен применять ТОВАР в соответствии со спецификациями ПРОИЗВОДИТЕЛЯ.

Для облегчения предложения по использованию и адаптации стандартной спецификации к конкретной продукции ПРОИЗВОДИТЕЛЯ, на всех продуктах, прайс-листах или каталогах есть специальные символы, указывающие на рекомендуемое ПРОИЗВОДИТЕЛЕМ использование для каждого продукта.

**3.2.** Различия в тональности или в цветности, которые могут оставаться неизменными, не связаны с дефектами ИЗДЕЛИЯ, а являются специфической характеристикой керамического материала, который был подвергнут высокотемпературному обжигу. Особенность «морозостойкости» применима только к продукции, которую ПРОИЗВОДИТЕЛЬ гарантировал специально для этой цели, посредством прямого указания в своих рекламных материалах и/или в прайс-листах. При отсутствие этого указания продукты будут рассматриваться исключительно для использования внутри помещений или, в любом случае, для использования в местах, которые не подвергаются воздействию атмосферных элементов, которые изменяют характеристики сопротивления или первоначальный внешний вид ПРОДУКТА (например: атмосферные осадки, солнце, влажность, низкие температуры и др.).

**3.3.** Мозаика с полированными поверхностями может изменить свой внешний вид при использовании на полу в помещениях, имеющих доступ снаружи, или в помещениях, где предполагается интенсивное движение пешеходов. Полированная мозаика также может быть скользкой, особенно когда она влажная или находится под воздействием влаги. По этой причине, ПРОИЗВОДИТЕЛЬ не рекомендует использовать эту ПРОДУКЦИЮ в общественных местах. Для пространства с интенсивным движением людей покупатель должен приобретать только ПРОДУКЦИЮ, классифицированную ПРОИЗВОДИТЕЛЕМ, как “PEI V” или “Универсальный Керамогранит”, в частности ту ПРОДУКЦИЮ, которую ПРОИЗВОДИТЕЛЬ рекомендует использовать в общественных местах.

**3.4.** Представление ПРОДУКЦИИ в брошюрах или в любых других рекламных материалах ПРОИЗВОДИТЕЛЯ носит исключительно иллюстративный характер и не обязательно отражает конечный эстетический результат установки этого конкретного продукта.

**3.5.** ПРОИЗВОДИТЕЛЬ гарантирует хорошее качество и отсутствие брака поставляемой ПРОДУКЦИИ. Гарантия не распространяется на ТОВАРЫ, классифицированные ПРОИЗВОДИТЕЛЕМ, как худшие по качеству, по 1-му выбору, или на те запасы продукции, которые были сняты с производства, когда они продаются оптом или указаны как специальные партии.

**3.6.** ПРОИЗВОДИТЕЛЬ не несет ответственности за любые дефекты и/или аномалии, обнаруженные в ПРОДУКЦИИ, которые являются следствием технических характеристик этих материалов, а являются результатом неправильного использования ПРОДУКЦИИ покупателями и/или третьими лицами, действующими от их имени. В частности, ПРОИЗВОДИТЕЛЬ не принимает никаких претензий или споров, связанных с ситуациями, описанными выше.

# основные условия продаж

—

## основные условия продаж

**3.7.** Претензии, связанные с наличием патентных или скрытых дефектов, должны быть предъявлены покупателем в письменной форме в адрес ПРОИЗВОДИТЕЛЯ в течение 60 дней с даты доставки товара. Ответственность ПРОИЗВОДИТЕЛЯ за дефекты, присущие товарам, доставленных покупателю, конкретно ограничена сроком в 2 года с даты получения товара покупателем.

**3.8.** Как правило, гарантия распространяется только на дефекты, обнаруженные в продукции, которая еще не была применена. В отношении дефектов, обнаруженных после применения ПРОДУКТОВ, гарантия действует только в том случае, если ПРОИЗВОДИТЕЛЬ подтвердил, что применение ПРОДУКТА было выполнено в соответствии с лучшими правилами деятельности (DIN 18352), а также в соответствии с процедурами, описанными ПРОИЗВОДИТЕЛЕМ в руководстве по применению и эксплуатации.

**3.9.** Гарантия, предоставляемая ПРОИЗВОДИТЕЛЕМ, ограничивается заменой дефектных продуктов на другие продукты того же типа, без дефектов, включая стоимость доставки. Возмещение любых других затрат и/или расходов и, в частности, затрат на снос и замену, категорически исключается. В любом случае, гарантия ПРОИЗВОДИТЕЛЯ не может превысить пятикратную стоимость востребованного продукта, до максимальной стоимости 10.000 евро.

**3.10.** ПРОИЗВОДИТЕЛЬ не несет ответственности за какие-либо претензии в связи с классификацией керамических материалов, проводимой органами сертификации и контроля, отличной от европейской, указанной в статье 3.1, на основании технических характеристик, не соответствующих указанными ПРОИЗВОДИТЕЛЕМ. Любой, возможный специализированный технический анализ, запрошенный покупателем, будет основан на соответствии продаваемых материалов техническим характеристикам, указанных ПРОИЗВОДИТЕЛЕМ, действующих, в настоящее время, в Португалии.

**4 – Цены и условия оплаты**

**4.1.** Продажные цены на ПРОДУКТЫ указаны в прейскуранте ПРОИЗВОДИТЕЛЯ, действующем на день подтверждения заказа. Для договоров купли-продажи с отдельными поставками стоимость будет соответствовать цене, указанной в прейскуранте, действующем на дату каждой поставки, если договаривающиеся стороны не указали иное направление.

Для ТОВАРОВ, предназначенных для зарубежных рынков, цена будет рассчитываться, по указанию ПРОИЗВОДИТЕЛЯ, в иностранной валюте страны назначения или в евро.

**4.2.** За исключением случаев, когда прямо оговорено иное, платежи будут производиться банковским переводом в течение 30 дней с даты выставления счета. Все банковские сборы и комиссии за перевод оплачивает покупатель. В случае задержки платежа ПРОИЗВОДИТЕЛЬ, совместно с любыми другими убытками, будет иметь право без предварительного уведомления покупателя, применить штрафную процентную ставку, эквивалентную 6-месячной ставке EURIBOR плюс 5%.

**5 - Представители производителя**

**5.1.** Агенты ПРОИЗВОДИТЕЛЯ способныют продаже ПРОДУКТОВ и не имеют права действовать от имени ПРОИЗВОДИТЕЛЯ, если только они не получат для этой цели специальное прямое разрешение.

**5.2.** Заказы, полученные агентами фирмы, не являются обязательными для ПРОИЗВОДИТЕЛЯ и поэтому должны быть письменно подтверждены самим ПРОИЗВОДИТЕЛЕМ.

**6 – Право собственности**

**6.1.** Между сторонами согласовано, что продажа ПРОДУКЦИИ осуществляется с правом собственности со стороны ПРОИЗВОДИТЕЛЯ до полной оплаты покупателем по согласованной цене. Однако риск потери товара переходит к покупателю при доставке ТОВАРА.

**6.2.** В случае продаж за границу, когда товары продаются и доставляются третьими лицами в рамках обычной коммерческой деятельности Покупателя и право собственности на товары еще не передано, право собственности ПРОИЗВОДИТЕЛЯ остается в силе с третьими сторонами.

**6.3.** В случае просрочки платежа, ПРОИЗВОДИТЕЛЬ имеет право, без необходимости прибегать к каким-либо формальностям, включая какое-либо предварительное уведомление покупателю, получить обратно все товары, подлежащие сохранению его праву собственности, и, если это законодательно закреплено, - все кредитные документы перед третьими лицами, сохраняя за собой право ПРОИЗВОДИТЕЛЯ, защищенное законом и имеющихся в распоряжении правовых средств, с целью компенсации понесенных убытков или возможных убытков, возникших в результате неисполнения обязательств Покупателем.

**7 – Форс-мажорная ситуация**

**7.1.** ПРОИЗВОДИТЕЛЬ не несет ответственности перед покупателем за любое нарушение контракта, включая непоставку или задержку доставки ТОВАРА, вызванные фактами, которые находятся вне его контроля, например, недоставкой или задержкой доставки материалов от поставщиков, поломки оборудования, забастовок, стихийных бедствий, перебоев в подаче электроэнергии, приостановки или транспортных затруднений.

**8 – Применимое законодательство – Компетентный Трибунал**

**8.1.** При толковании, интеграции или исправлении данных условий применяются положения, содержащиеся в Декрете-Законе № 67/2003, от 8 апреля, которые не были отменены соглашением сторон.

## index

—

### colour map

—

### collections

—

### linea collections

—

### useful information

—

### calibers

### certification

### general sales

### conditions

### important notes

### magres green

### laying suggestions

### outdoor extra thick

### package

### pr()tect

### symbols

### technical information

### think zero



# condizioni generali di vendita

—

—

**1 - Applicabilità delle condizioni**

**1.1.** Le condizioni generali ivi riportate e specificate - di seguito denominate “CONDIZIONI” - formano parte integrante del contratto di compravendita di piastrelle e altri prodotti ceramici - di seguito denominati “PRODOTTO” o “PRODOTTI” - realizzati da Margres - Gres Panaria Portugal, S.A., denominata anche “PRODUTTORE”.

**1.2.** Salvo casi specifici o eccezionali, in cui l'applicazione di queste condizioni è espressamente modificata per accordo scritto e firmato dal PRODUTTORE, esse rappresentano le condizioni esclusive applicate a tale vendita. Se una o più parti delle presenti CONDIZIONI o dei contratti, considerate singolarmente e di cui fanno parte, dovessero risultare in qualche modo nulle, invalide o inapplicabili per cause di forza maggiore, le CONDIZIONI generali o particolari rimarranno valide nella loro interezza e le condizioni invalide saranno sostituite da nuove disposizioni che riproducano, per quanto possibile, l'intenzione originaria delle parti.

**2 - Esecuzione del contratto di vendita - Consegna dei prodotti**

**2.1.** Il contratto è concluso quando la parte offerente o l'acquirente è a conoscenza dell'accettazione scritta della controparte.

**2.2.** Un ordine che non sia stato confermato per iscritto non può in nessun caso essere considerato come non accettato, a meno che non sia stato eseguito dal PRODUTTORE inviando o consegnando i PRODOTTI. La consegna parziale dei PRODOTTI ordinati non implica l'accettazione dell'intero ordine, ma solo della parte dei PRODOTTI effettivamente consegnati.

**2.3.** Se non diversamente ed espressamente concordato per iscritto in anticipo, la consegna dei PRODOTTI avverrà esclusivamente Ex-works.

**2.4.** Se non espressamente concordato diversamente, tutte le date indicate per la consegna sono da considerarsi date approssimative.

**3 - Caratteristiche dei prodotti - Garanzia - Reclami**

**3.1.** I PRODOTTI realizzati da Margres - Gres Panaria Portugal, S.A. sono realizzati in conformità alle norme europee applicabili. Il PRODUTTORE vende preferibilmente a rivenditori professionali, che hanno la responsabilità di fornire informazioni tecniche corrette e appropriate agli utenti finali o ai rivenditori.

La classificazione dei PRODOTTI è indicata dal PRODUTTORE nel materiale pubblicitario e/o nei listini prezzi. Di conseguenza, l'acquirente utilizzerà i PRODOTTI in conformità alle specifiche del PRODUTTORE.

Per facilitare il suggerimento d'uso e adattare la specifica standard alla specifica produzione del PRODUTTORE, su tutti i prodotti, listini prezzi o cataloghi sono presenti simboli specifici che indicano l'uso consigliato per ogni prodotto dal PRODUTTORE.

**3.2.** Eventuali differenze di tonalità o cromaticanza non sono dovute a difetti del PRODOTTO, ma sono una caratteristica specifica del materiale ceramico che è stato sottoposto a cottura ad alte temperature. La particolare caratteristica della “resistenza al congelamento” si applica solo ai prodotti che il PRODUTTORE ha espressamente garantito a tale scopo mediante un'espressa indicazione nel suo materiale pubblicitario e/o nei listini prezzi. In assenza di tale indicazione, i prodotti saranno considerati solo ed esclusivamente per uso interno o, comunque, per uso in luoghi non esposti ad elementi atmosferici che alterino le caratteristiche di resistenza o l'aspetto originale del PRODOTTO (ad es. precipitazioni atmosferiche, sole, umidità, basse temperature, ecc.)

**3.3.** Le piastrelle lucide possono cambiare il loro aspetto se utilizzate sul pavimento di ambienti che hanno accesso dall'esterno, o di ambienti soggetti a calpestio intenso. Le piastrelle lucide possono anche essere scivolose, soprattutto se bagnate o umide. Per questo motivo, il PRODUTTORE sconsiglia l'utilizzo di questi PRODOTTI in luoghi pubblici. Per gli ambienti soggetti a calpestio intenso, l'acquirente deve acquistare solo PRODOTTI classificati dal PRODUTTORE come “PEI V” o “Gres Porcellanato a Tutta Massa”, in particolare quei PRODOTTI che il PRODUTTORE raccomanda specificamente per l'uso in luoghi pubblici.

**3.4.** Le presentazioni dei PRODOTTI nelle brochure o in qualsiasi altro materiale promozionale del PRODUTTORE sono puramente illustrative e non rappresentano necessariamente il risultato estetico finale risultante dalla posa di questo specifico prodotto.

**3.5.** Il PRODUTTORE garantisce la buona qualità e l'assenza di difetti nei PRODOTTI forniti.

La garanzia non si applica ai PRODOTTI classificati dal PRODUTTORE come inferiori alla qualità di prima scelta, né alle scorte di prodotti fuori produzione, se venduti sfusi o indicati come lotti speciali.

**3.6.** Il PRODUTTORE non sarà responsabile di eventuali difetti e/o anomalie dei PRODOTTI che non derivino dalle specifiche tecniche dei PRODOTTI, ma che derivino piuttosto dall'uso improprio dei PRODOTTI da parte degli acquirenti e/o di terzi che agiscono per loro conto. In particolare, il PRODUTTORE non accetta reclami o controversie relative alle situazioni sopra descritte.

—

—

**3.7.** Le richieste di risarcimento per vizi di brevetto o per vizi occulti devono essere presentate per iscritto dall'acquirente al PRODUTTORE entro 60 giorni dalla data di consegna della merce. La responsabilità del produttore per i difetti inerenti alla merce consegnata al cliente è espressamente limitata a 2 anni dalla data di ricevimento della merce da parte del cliente.

**3.8.** In generale, la garanzia è valida solo per i difetti riscontrati sui prodotti che non sono ancora stati applicati. Per i difetti rilevati dopo l'applicazione del PRODOTTO, la garanzia può essere applicata solo se il PRODUTTORE ha confermato che la posa del PRODOTTO è stata eseguita a regola d'arte (DIN 18352), oltre che secondo le procedure descritte nel manuale di posa e manutenzione del PRODUTTORE.

**3.9.** La garanzia concessa dal PRODUTTORE è limitata alla sostituzione dei prodotti difettosi con altri prodotti dello stesso tipo senza difetti, più le spese di trasporto. È espressamente escluso il rimborso di eventuali altri costi e/o spese, in particolare le spese di demolizione e di trasloco. In ogni caso, la garanzia del PRODUTTORE non può superare il quintuplo del valore del materiale richiesto, fino ad un massimo di 10.000 euro.

**3.10.** Il PRODUTTORE non è responsabile di eventuali reclami dovuti ad una classificazione dei materiali ceramici effettuata da enti di certificazione e controllo diversi da quelli europei di cui all'art. 3.1 sulla base di specifiche tecniche che non corrispondono a quelle indicate dal PRODUTTORE. Qualsiasi analisi tecnica specialistica richiesta dall'acquirente si baserà sulla corrispondenza dei materiali venduti con le caratteristiche tecniche indicate dal PRODUTTORE, all'epoca in vigore in Portogallo.

**4 - Prezzi e condizioni di pagamento**

**4.1.** I prezzi di vendita dei PRODOTTI sono quelli indicati nel listino prezzi del PRODUTTORE in vigore alla data della conferma d'ordine. Per i contratti di vendita con consegne separate, il prezzo è quello indicato nel listino prezzi in vigore alla data di ciascuna delle consegne, a meno che le parti contraenti non abbiano scritto diversamente.

Per i PRODOTTI destinati ai mercati esteri il prezzo sarà calcolato, con indicazione del PRODUTTORE, nella valuta estera del paese di destinazione o in euro.

**4.2.** Se non espressamente concordato diversamente, i pagamenti devono essere effettuati tramite bonifico bancario entro 30 giorni dalla data della fattura. Tutte le spese bancarie e di bonifico sono a carico dell'Acquirente. In caso di ritardo nel pagamento, il FORNITORE, insieme a qualsiasi altra perdita, avrà il diritto, senza preavviso all'acquirente, di applicare un tasso di interesse di mora e punitivo pari all'EURIBOR a 6 mesi più il 5%.

**5 – Agenti del Produttore**

**5.1.** Gli agenti del PRODUTTORE promuovono la vendita dei PRODOTTI e non sono autorizzati ad agire in nome e per conto del PRODUTTORE, a meno che non ottengano un'espressa autorizzazione specifica in tal senso.

**5.2.** Gli ordini ricevuti dagli agenti non sono vincolanti per il PRODUTTORE e devono quindi essere espressamente accettati per iscritto dal PRODUTTORE stesso.

**6 - Prenotazione di immobili**

**6.1.** Le parti concordano che la vendita dei PRODOTTI verrà effettuata con riserva di proprietà da parte del PRODUTTORE fino al completo pagamento del prezzo concordato da parte dell'Acquirente. Tuttavia, il rischio di perdita della merce viene trasferito all'acquirente al momento della consegna dei PRODOTTI.

**6.2.** Nel caso di vendite all'estero, quando la merce viene venduta e consegnata a terzi nel normale corso della normale attività commerciale dell'Acquirente e la proprietà della merce non è ancora stata trasferita, la riserva di proprietà del PRODUTTORE rimane valida nei confronti del terzo.

**6.3.** In caso di ritardo nei pagamenti, il PRODUTTORE ha il diritto, senza alcuna formalità, compreso qualsiasi preavviso all'acquirente, di ritirare tutti i beni soggetti a riserva di proprietà e, se previsto dalla legge, tutti i titoli di credito di fronte a terzi, essendosi espressamente riservato il diritto del PRODUTTORE di utilizzare tutti i mezzi legali a sua disposizione al fine di recuperare i danni che ha subito o subirà a causa del comportamento inadempiente dell'acquirente.

**7 - Caso di forza maggiore**

**7.1.** Il PRODUTTORE non sarà responsabile nei confronti dell'acquirente per qualsiasi violazione del contratto, inclusa la mancata o ritardata consegna del PRODOTTO, causata da fatti al di fuori del suo controllo, come la mancata o ritardata consegna dei materiali da parte dei fornitori, guasti agli impianti, scioperi, forze della natura, interruzioni dell'alimentazione elettrica, sospensione o difficoltà di trasporto.

**8 - Legge applicabile - Foro competente**

**8.1.** Per l'interpretazione, l'integrazione o la rettifica delle presenti condizioni, valgono le disposizioni contenute nel D.L. 8 aprile 2003, n. 67/2003, che non siano state rimosse di comune accordo tra le parti.

## GRES PANARIA

Portugal S.A.

© COPYRIGHT GRES PANARIA PORTUGAL S.A.

—

—

—

All data presented in this catalogue is for information purposes only and is therefore not binding.

Margres reserves the right to, at any time, modify any data set out in this catalogue without prior warning. The colours of the products in this catalogue are indicative and may vary significantly.

Margres is constantly concerned with its clients needs, frequently restores the company's product range, since not all product samples published in the catalogue are compulsory certified.

—

—

—

—

—

—

—

—

—

—

—

—

—

—

—

—

—

—

—

—

—

—

—

—

—

—

—

—

—

—

—

—

—

—

—

—

—

—

# important notes

notes importantes . wichtige hinweise . notas importantes —

—

—

—

—

—

—

—

—

—

—

—

—

—

—

—

—

—

—

—

—

—

—

—

—

—

—

—

—

—

—

—

—

—

—

—

—

—

—

—

—

—

—

index

—

—

—

—

—

—

—

—

—

—

—

—

—

—

—

—

—

—

—

—

—

—

—

—

—

—

—

—

—

—

—

—

—

—

—

—

—

—

—

—

—

—

—

—

—

—

—

—

—

—

—

—

—

—

—

—

—

—

—

—

—

—

—

—

—

—

—

—

—

—

—

—

—

—

—

—

—

—

—

—

—

—

—

—

—

—

—

—

—

—

—

—

—

—

—

—

—

—

—

—

—

**MARGRES**  
CERAMIC TILES



**MARGRES**  
CERAMIC TILES

Gres Panaria Portugal S.A  
Chousa Nova - 3830-133 Ílhavo - PORTUGAL

e-mail: [margres@margres.com](mailto:margres@margres.com)  
[www.margres.com](http://www.margres.com)



APICER  
associação portuguesa das indústrias  
de cerâmica e cristalaria



projeto gráfico: Viriato & Viriato  
coordenação: Marketing Margres  
fotografia: MHP - Viriato & Viriato  
impressão: Viriato & Viriato  
edição de fevereiro 2023

[index](#)

[colour map](#)

[collections](#)

[linea collections](#)

[useful information](#)



**MARGRES**  

---

**CERAMIC TILES**