

YOUR MATCH

YMM

CERAMICHE  
SUPERGRES

# Y M START TO CREATE

The traditional and the cutting-edge come together to create "Your Match". The strong personality of craft-based cement is reinterpreted and transformed into ceramic surfaces that faithfully replicate its surface effect, the action of time, and the inclusion of inert materials. The project is embellished by the white body wall tiling, in the large rectified 50x120 size, available in a variety of colours, both on a smooth background as well as in three-dimensional structures and decorations that extend the design possibilities and generate unprecedented interior design solutions. Suitable for all types of settings, "Your Match" has taken shape to interpret the contemporary design spirit, the ideal inspiration to combine colours and sizes that share a single, personal style: yours. Start creating.

« Your Match » est née de la rencontre entre tradition et avant-garde. La forte personnalité du ciment artisanal est revisitée et transformée en surfaces céramiques qui en reproduisent fidèlement l'effet de surface, l'action du temps, les inclusions de matériaux inertes. Elle enrichit le projet de revêtement en pâte blanche, dans le grand format rectifié 50x120, réalisé en diverses nuances, aussi bien sur fond lisse que sur des structures tridimensionnelles et des décors qui accroissent les possibilités de conception et permettent des solutions d'ameublement inattendues. Adaptée à tous les types d'espaces, « Your Match » prend forme pour interpréter l'esprit conceptuel contemporain, l'inspiration idéale pour associer couleurs et formats animés par un style unique et personnel : le vôtre. Commencez vos créations.

„Your Match“ entsteht aus der Begegnung zwischen Tradition und Avantgarde. Die starke Persönlichkeit des handwerklichen Zements wird neu interpretiert und in keramische Oberflächen umgewandelt, die den Oberflächeneffekt, die Wirkung der Zeit und die Einschlüsse von inerten Materialien getreu wiedergeben. Das Projekt wird durch weißscherbige Wandbeläge im Format 50x120 bereichert, die in verschiedenen Farbtönen, auf glattem Untergrund oder mit dreidimensionalen Strukturen und Dekorationen hergestellt werden, die die Gestaltungsmöglichkeiten erweitern und unerwartete Einrichtungslösungen ermöglichen. „Your Match“ eignet sich für alle Arten von Umgebungen und nimmt Gestalt an, um den zeitgenössischen Designgeist zu interpretieren. Es ist die ideale Inspiration, um Farben und Formate zu kombinieren, die durch einen einzigartigen und persönlichen Stil belebt werden: Ihren. Beginnen Sie mit der Kreation.

# YOUR MATCH

"Your Match" nasce dall'incontro fra tradizione ed avanguardia. La forte personalità del cemento artigianale è reinterpretata e trasformata in superfici ceramiche che ne riproducono fedelmente l'effetto superficiale, l'azione del tempo, le inclusioni di materiali inerti. Arricchisce il progetto il rivestimento in pasta bianca, nel grande formato rettificato 50x120, realizzato in diverse tonalità, sia su fondo liscio che in strutture tridimensionali e decori che ampliano le possibilità progettuali e permettono soluzioni d'arredo inaspettate.

Adatta a tutti i tipi di ambienti, "Your Match" prende forma per interpretare lo spirito progettuale contemporaneo, l'ispirazione ideale per abbinare colori e formati animati da uno stile unico e personale: il tuo. Comincia a creare.

Gres Porcellanato . Porcelain stoneware . Grès cérame . Feinsteinzeug

## FLOOR & WALL

Rivestimento in pasta bianca . White body wall tile . Revêtements en pâte blanche . Weisscherbiger Wandfliesen

## INDEX

|                                    |           |
|------------------------------------|-----------|
| <b>Introduction</b> .....          | <b>2</b>  |
| <b>Floor</b> .....                 | <b>7</b>  |
| <b>Wall</b> .....                  | <b>45</b> |
| <b>Informazioni tecniche</b> ..... | <b>70</b> |

CERAMICHE  
SUPERGRES

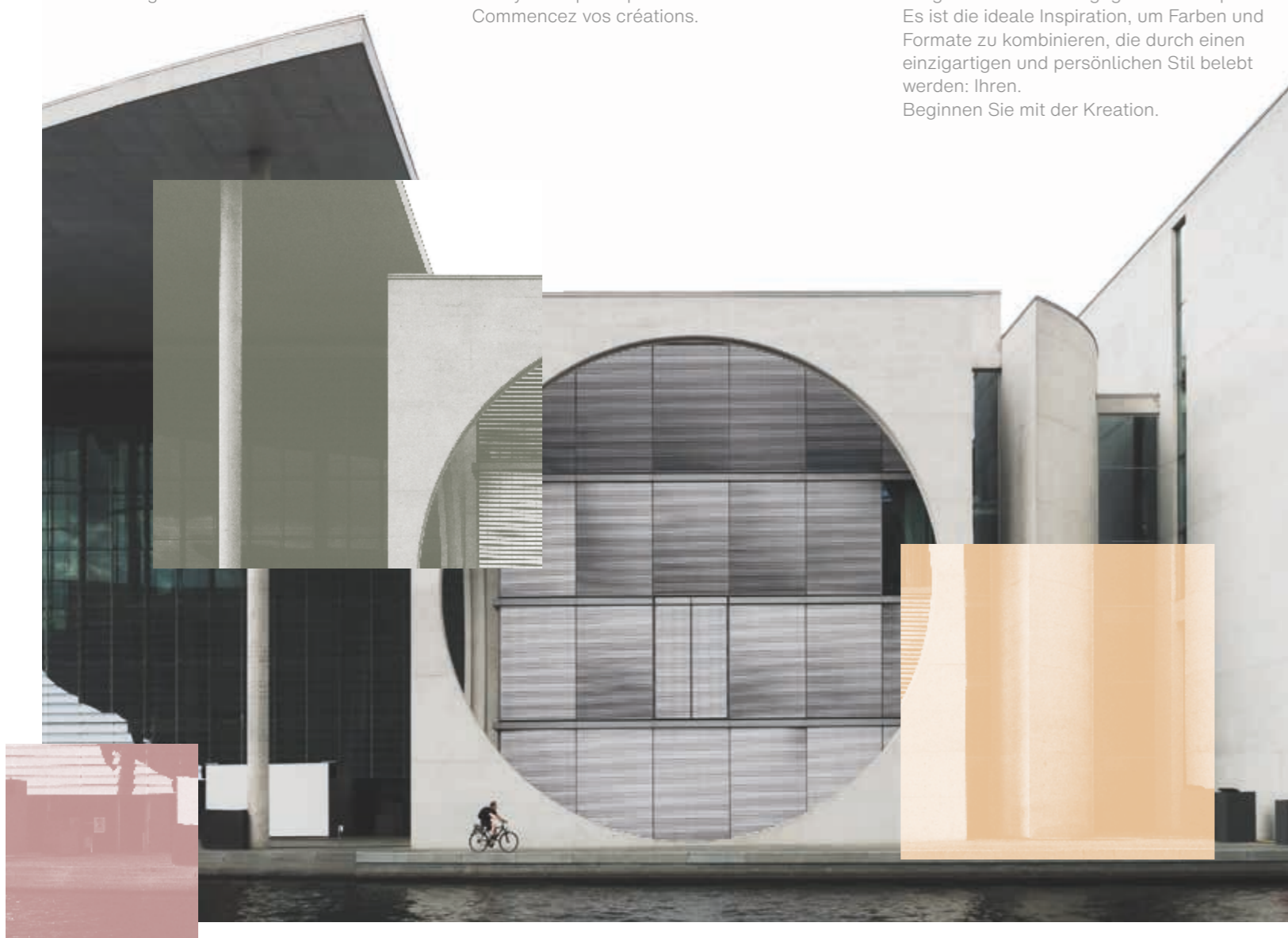

# YOUR MATCH FLOOR

Gres Porcellanato  
Porcelain stoneware  
Grès cérame  
Feinsteinzeug

Una materia ispirata al cemento artigianale, caratterizzata dalla naturalezza della superficie, declinata in un'ampia palette di colori che spazia da tonalità neutre ed essenziali, fino ad arrivare a colori più contemporanei.

Realizzato in gres porcellanato, "Your Match" può essere utilizzato in ambienti pubblici e residenziali, unendo l'estetica materica del cemento alle prestazioni del gres, con una superficie morbida al tatto, igienica e facile da pulire.

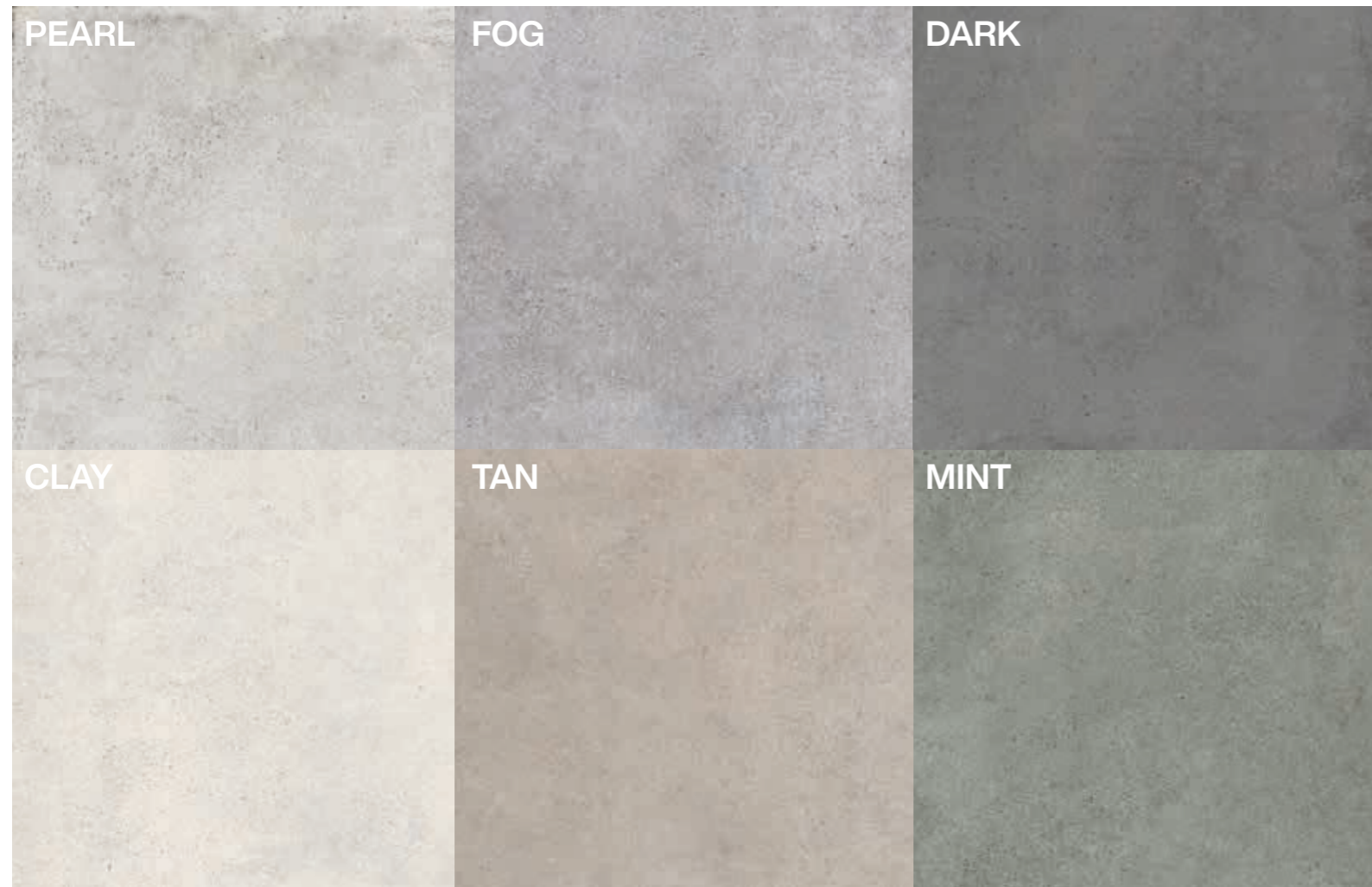

A material inspired by craft-based cement, distinguished by the natural appeal of the surface, declined in an extensive array of colours ranging from neutral, understated hues, to more contemporary shades.

Made of porcelain tiles, Your Match can be used in public and residential settings, combining the textured styling of cement with the performance of stoneware, with a soft-touch, hygienic and easy-to-clean surface.

Un matériau inspiré du ciment artisanal, caractérisé par l'esprit naturel de la surface, décliné dans une large palette de couleurs qui va des teintes neutres et essentielles à des couleurs plus contemporaines.

Réalisée en grès cérame, Your Match peut être utilisée dans des espaces publics et résidentiels, en associant l'esthétique matérielle du ciment aux performances du grès, avec une surface douce au toucher, hygiénique et facile à nettoyer.

Ein Material, das von handgefertigtem Beton inspiriert ist, sich durch die Natürlichkeit der Oberfläche auszeichnet und in einer breiten Farbpalette von neutralen und essentiellen Tönen bis hin zu moderneren Farben erhältlich ist.

Your Match ist aus Feinsteinzeug hergestellt und kann in öffentlichen und privaten Bereichen eingesetzt werden. Es verbindet die Ästhetik des Betons mit den Eigenschaften des Feinsteinzeugs und hat eine weiche, hygienische und leicht zu reinigende Oberfläche.

# 120x120 RT 60x120 RT 60x60 RT 30x60 RT

YOUR MATCH, un cemento ceramico originale e autenticamente unico. Ogni singola lastra, infatti, si ispira a manufatti realizzati artigianalmente, da laboratori di ricerca e sviluppo Supergres per soddisfare al meglio le esigenze progettuali contemporanee. Il movimento estetico è armonico, tanto nei passaggi di tono quanto nella grafica, ricca di suggestioni ma sempre equilibrata e raffinata.



YOUR MATCH, an original and authentically unique ceramic cement. Indeed, every individual slab draws its inspiration from craft-based products made by the Supergres R&D labs to accommodate contemporary design needs.

The aesthetic movement is harmonious, in both the shifts in shade and in the graphics, which are packed with suggestions but always well-balanced and sophisticated.

YOUR MATCH, un ciment céramique original et authentiquement unique. En effet, chaque dalle s'inspire de produits réalisés de manière artisanale, par les laboratoires de recherche et développement Supergres, pour satisfaire au mieux les exigences de conception contemporaines.

Le mouvement esthétique est harmonieux, aussi bien dans les changements de teinte que dans le dessin, riche en suggestions mais toujours équilibré et raffiné.

YOUR MATCH, ein origineller und authentischer Keramikzement. Jede einzelne Platte ist von handgefertigten Produkten inspiriert, die in den Forschungs- und Entwicklungslabors von Supergres hergestellt werden, um die Anforderungen des modernen Designs bestmöglich zu erfüllen.

Die ästhetische Bewegung ist harmonisch, sowohl in den Tonübergängen als auch in der Grafik, reich an Anregungen, aber immer ausgewogen und raffiniert.

# YOUR MATCH WALL

Rivestimento in pasta bianca  
White body wall tile  
Revêtements en pâte blanche  
Weisscherbiger Wandfliesen

Il colore protagonista delle pareti con superfici specifiche in pasta bianca. Nel formato 50x120, si inseriscono 6 colori che aggiungono vitalità e freschezza a bagni, cucine e spazi commerciali. Una gamma cromatica stimolante per comporre abbinamenti unici tra pavimenti e rivestimenti.

## 50x120 RT

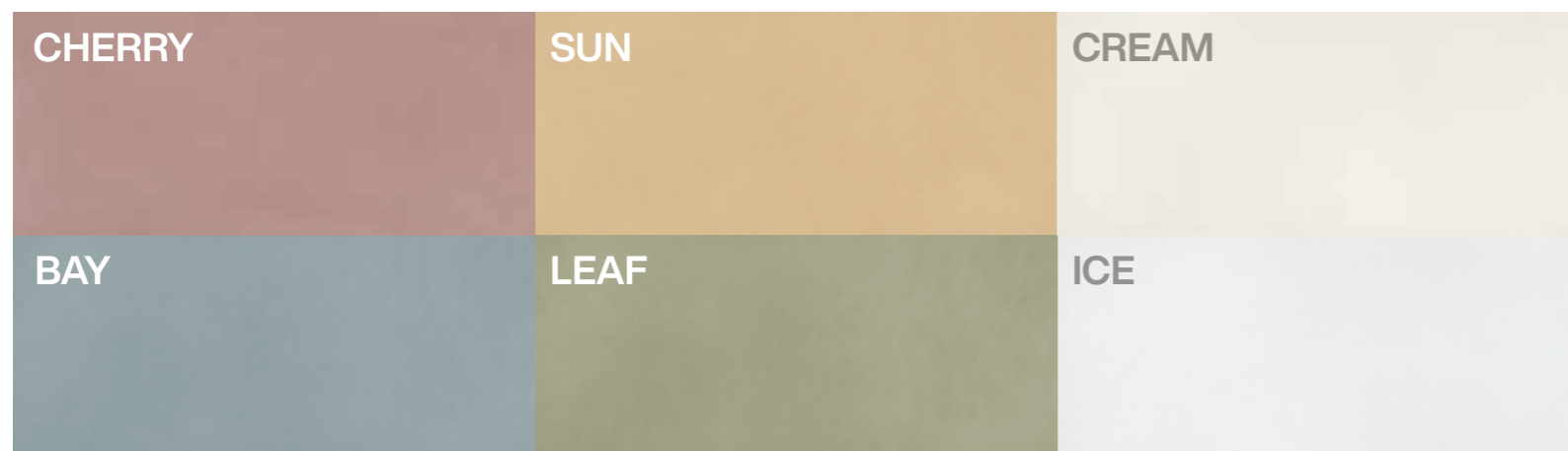

Colour plays the starring role of the walls with specific white body surfaces. In the 50x120 size, 6 colours are introduced, to add vitality and a fresh look to bathrooms, kitchens and commercial settings. A stimulating colour range to put together unique combinations of floor tiles and wall tiles.

La couleur, acteur majeur des parois avec des surfaces spécifiques en pâte blanche. Le format 50x120 inclut 6 couleurs qui apportent de la vitalité et de la fraîcheur à des salles de bains, des cuisines et des espaces commerciaux. Une gamme de couleurs stimulante pour composer des assortiments uniques entre sols et revêtements muraux.

Die Farbe ist der Protagonist der Wände mit speziellen weißscherbigen Belägen. Im Format 50x120 werden 6 Farben verwendet, um Bädern, Küchen und Geschäftsumgebungen Vitalität und Frische zu verleihen. Eine anregende Farbpalette zur Zusammenstellung einzigartiger Kombinationen von Boden- und Wandbelägen.

## STRUTTURA LINE

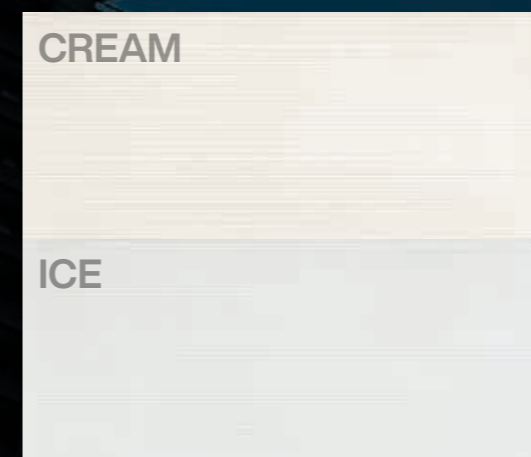

La gamma si completa con una struttura tridimensionale nei colori bianco e beige e 6 diversi decori, caratterizzati da trame floreali e soggetti contemporanei.

The range is completed by a three-dimensional structure in white and beige and 6 different decorations, distinguished by floral patterns and contemporary subjects.

La gamme est complétée par une structure tridimensionnelle dans les couleurs blanc et beige et 6 décors différents, caractérisés par des trames florales et des sujets contemporains.

Die Serie wird durch eine dreidimensionale Struktur in Weiß und Beige und 6 verschiedene Dekore mit floralen Mustern und zeitgenössischen Motiven ergänzt.

## DECORS

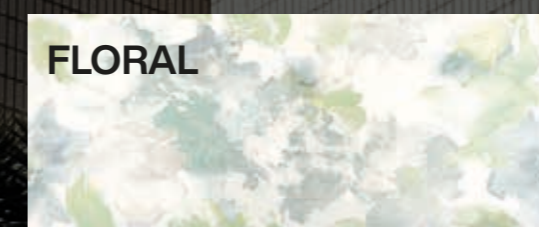
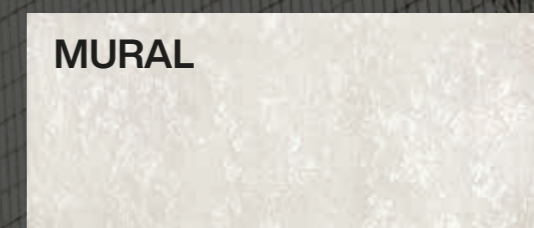

Y M

**YOUR MATCH  
FLOOR**

Gres Porcellanato . Porcelain stoneware . Grès cérame . Feinsteinzeug

# MINT

YOUR MATCH

Suggerzioni naturali per spazi commerciali e ambienti domestici, caratterizzati da originali espressioni di stile.

Natural suggestions for commercial venues and domestic settings, characterised by original expressions of style.

Suggestions naturelles pour des espaces commerciaux et domestiques, caractérisés par des expressions de style originales.

Natürliche Vorschläge für gewerbliche und private Räume, die sich durch einen originellen Ausdruck des Stils auszeichnen.

Mint 120x120 RT . 48"x48"  
Mint 30x60 RT . 12"x24"  
Pearl 60x120RT . 24"x48"





Mint 120x120 RT . 48"x48"  
Mint 30x60 RT . 12"x24"  
Pearl 60x120RT . 24"x48"

YM





# DARK

YOUR MATCH

Intensità e definizione risaltano nei toni scuri. Ideali per creare contrasti decisi in ambienti urban chic contemporanei.

Intensity and definition stand out in dark hues. Ideal for creating bold contrasts in contemporary urban chic environments.

Intensité et définition ressortent dans les teintes sombres. Idéales pour créer des contrastes marqués dans des espaces urban chic contemporains.

Intensität und Schärfe zeichnen sich bei dunklen Tönen aus. Ideal für kühne Kontraste in modernen, urban-schicken Umgebungen.

Dark 120x120 RT . 48"x48"





# FOOG

YOUR MATCH

Una nuance profonda e autentica che risponde ai criteri di un'immagine moderna ed essenziale.

A deep and authentic nuance that meets the need for a modern and elemental image.

Une nuance profonde et authentique qui répond aux critères d'une image moderne et essentielle.

Ein tiefer und authentischer Farbton, der die Kriterien eines modernen und essentiellen Images erfüllt.

Fog 60x120 RT . 24"x48"



Fog 60x120 RT . 24"x48"  
Collection Purity of Marble Breccia: Breccia Nera Lux 120x278 RT . 48"x109 1/2"



# PEARL

YOUR MATCH

Sobrio ed elegante, “Pearl”  
esprime la sua piena versatilità in  
accostamento a tinte a contrasto o  
tone-sur-tone.

Simple yet stylish, “Pearl” expresses its full versatility in  
combination with contrasting or tone-on-tone hues.

Sobre et élégante, « Pearl » exprime toute sa polyvalence en  
assortiment avec des nuances en contraste ou ton sur ton.

Dezent und elegant zeigt „Pearl“ seine ganze Vielseitigkeit in  
Kombination mit kontrastierenden oder Ton-in-Ton-Farben.

Pearl 120x120 RT . 48"x48"





Pearl 120x120 RT . 48"x48"

YM

# CLAY

YOUR MATCH

Morbido ed elegante, con tonalità neutre e delicate, CLAY racchiude comfort ed equilibrio esaltando il piacere del vivere quotidiano.

Soft and elegant, with neutral and gentle hues, CLAY encompasses comfort and balance, emphasising the pleasure of everyday life.

Douce et élégante, avec des teintes neutres et délicates, CLAY regroupe confort et équilibre en accentuant le plaisir de vivre au quotidien.

Weich und elegant, mit zarten, neutralen Tönen, bietet CLAY Komfort und Ausgeglichenheit zur Steigerung der Freude am täglichen Leben.

Clay 120x120 RT . 48"x48"





Clay 120x120 RT . 48"x48"

YM



# TAN

YOUR MATCH

Il tono naturale della superficie TAN dona calore all'ambiente e lo caratterizza con un rassicurante e formale equilibrio.

The natural hue of the TAN surface lends its surroundings warmth and distinguishes them with a reassuring and formal balance.

La teinte naturelle de la surface TAN apporte de la chaleur à l'espace et le caractérise dans un équilibre rassurant et formel.

Der natürliche Ton der TAN-Oberfläche verleiht dem Raum Wärme und prägt ihn mit einem beruhigenden formalen Gleichgewicht.





Tan 120x120 RT . 48"x48"  
Mural 50x120 RT . 20"x48"

YM

## YOUR MATCH / FLOOR

Gres Porcellanato . Porcelain stoneware . Grès cérame . Feinsteinzeug

EN 14411 Allegato G - Piastrelle di ceramica pressate a secco con basso assorbimento d'acqua (Ev ≤ 0,5%)  
EN 14411 Appendix G - Dry pressed ceramic tiles with low water absorption (Ev ≤ 0,5%)

# MINT

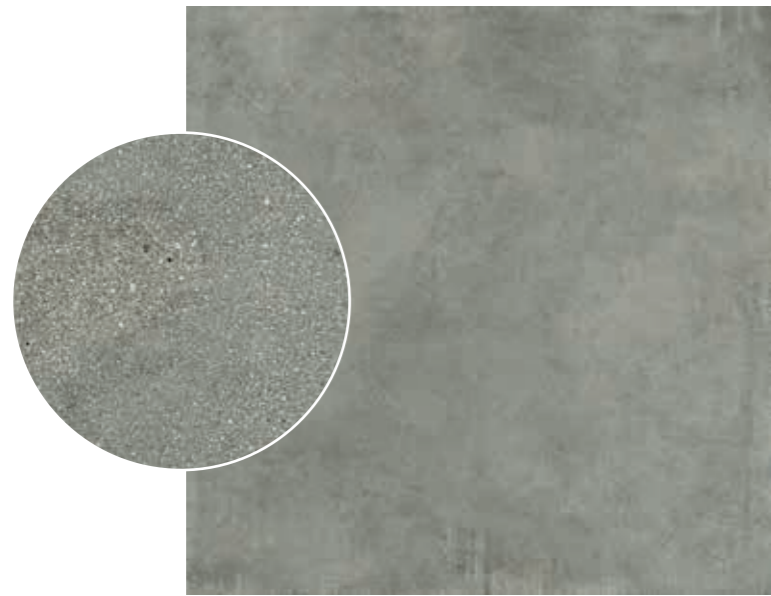

120x120 RT . 48"x48"

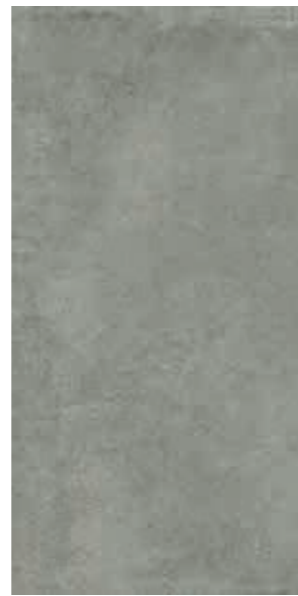

60x120 RT . 24"x48"



30x60 RT . 12"x24"

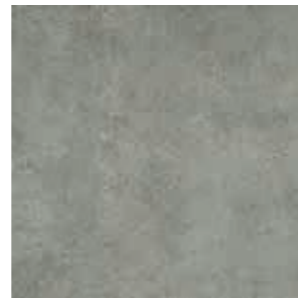

60x60 RT . 24"x24"



# DARK

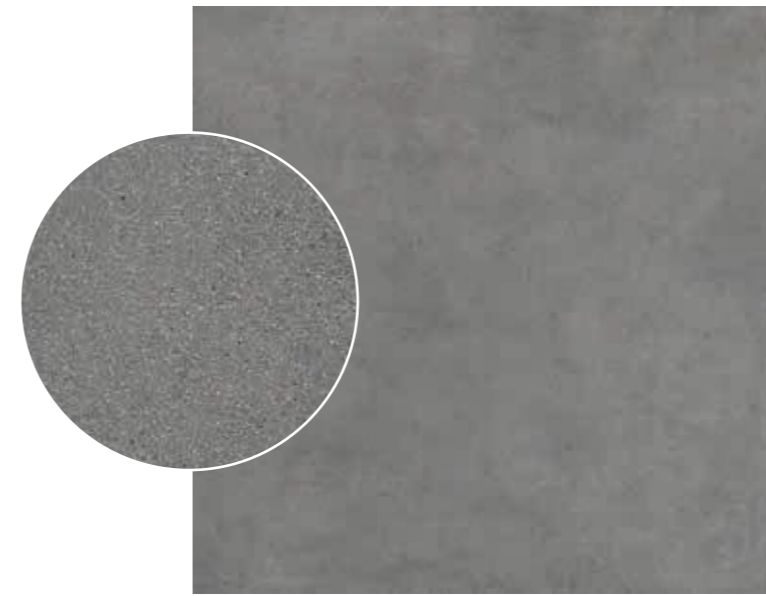

120x120 RT . 48"x48"



60x120 RT . 24"x48"



30x60 RT . 12"x24"

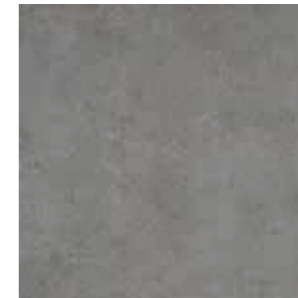

60x60 RT . 24"x24"



# YOUR MATCH / FLOOR

Gres Porcellanato . Porcelain stoneware . Grès cérame . Feinsteinzeug

EN 14411 Allegato G - Piastrelle di ceramica pressate a secco con basso assorbimento d'acqua (Ev ≤ 0,5%)  
EN 14411 Appendix G - Dry pressed ceramic tiles with low water absorption (Ev ≤ 0,5%)

# FOG

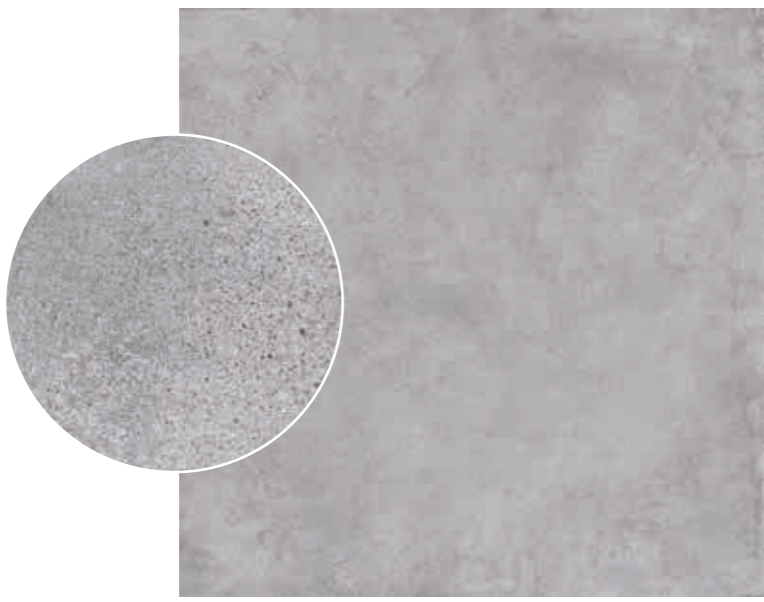

120x120 RT . 48"x48"



60x120 RT . 24"x48"



30x60 RT . 12"x24"



60x60 RT . 24"x24"



# PEARL



120x120 RT . 48"x48"

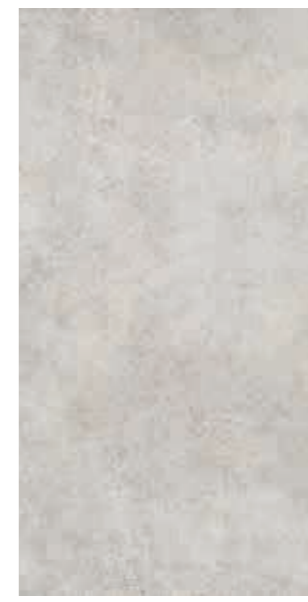

60x120 RT . 24"x48"



30x60 RT . 12"x24"



60x60 RT . 24"x24"



## YOUR MATCH / FLOOR

Gres Porcellanato . Porcelain stoneware . Grès cérame . Feinsteinzeug

EN 14411 Allegato G - Piastrelle di ceramica pressate a secco con basso assorbimento d'acqua (Ev ≤ 0,5%)  
EN 14411 Appendix G - Dry pressed ceramic tiles with low water absorption (Ev ≤ 0,5%)

# TAN



120x120 RT . 48"x48"

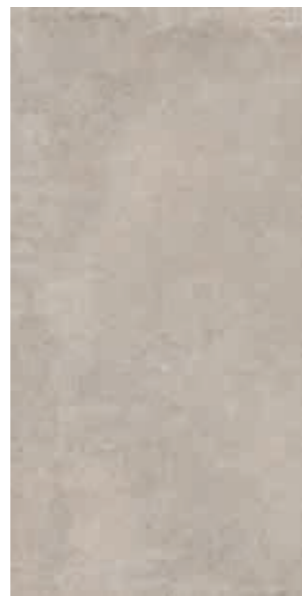

60x120 RT . 24"x48"

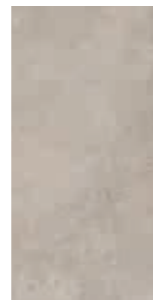

30x60 RT . 12"x24"



60x60 RT . 24"x24"



# CLAY



120x120 RT . 48"x48"



60x120 RT . 24"x48"



30x60 RT . 12"x24"



60x60 RT . 24"x24"



## YOUR MATCH / MOSAICS

Gres Porcellanato . Porcelain stoneware . Grès cérame . Feinsteinzeug

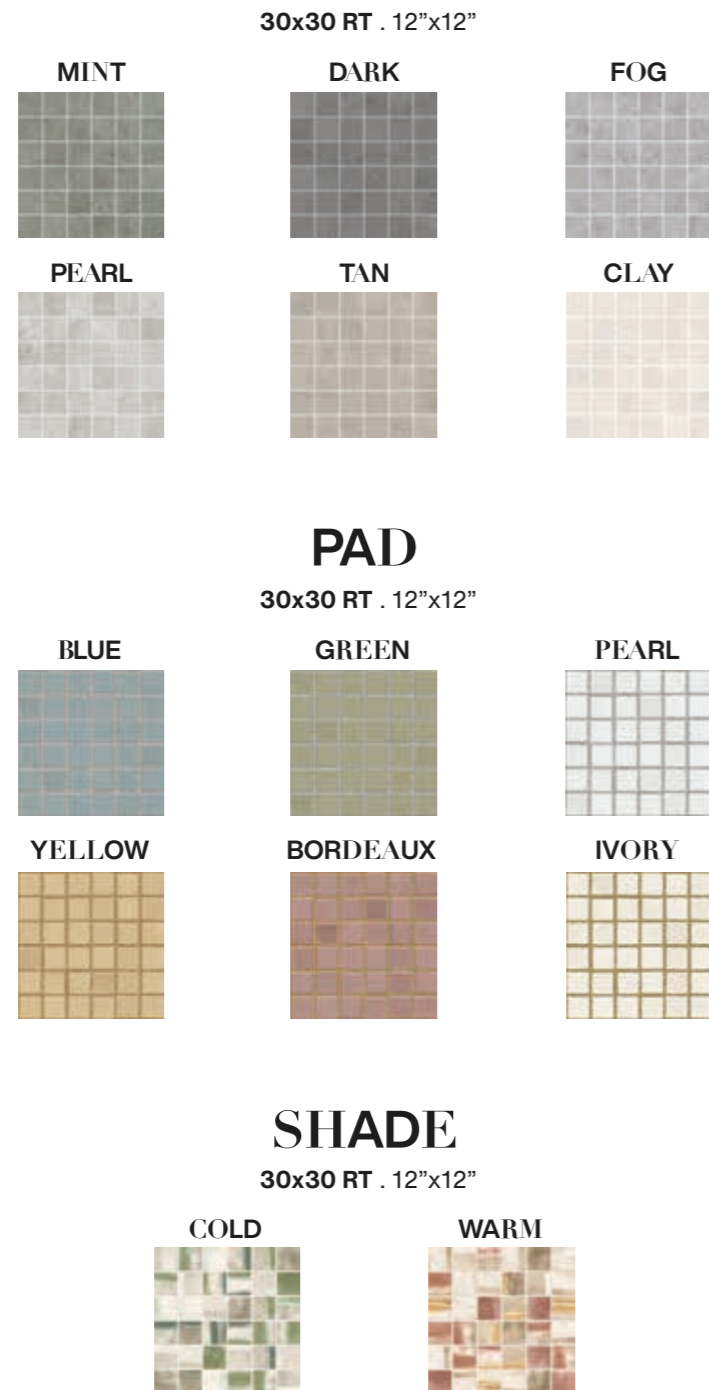

## PEZZI SPECIALI

Trims / Pièces Spéciales / Formstücke

**Pezzi speciali disponibili su tutti i colori, su ordinazione.**  
Trim tiles available in all colors, to order.  
**Pièces spéciales disponibles dans toutes les couleurs, sur demande.**  
Formteile auf Bestellung in allen Farben verfügbar.

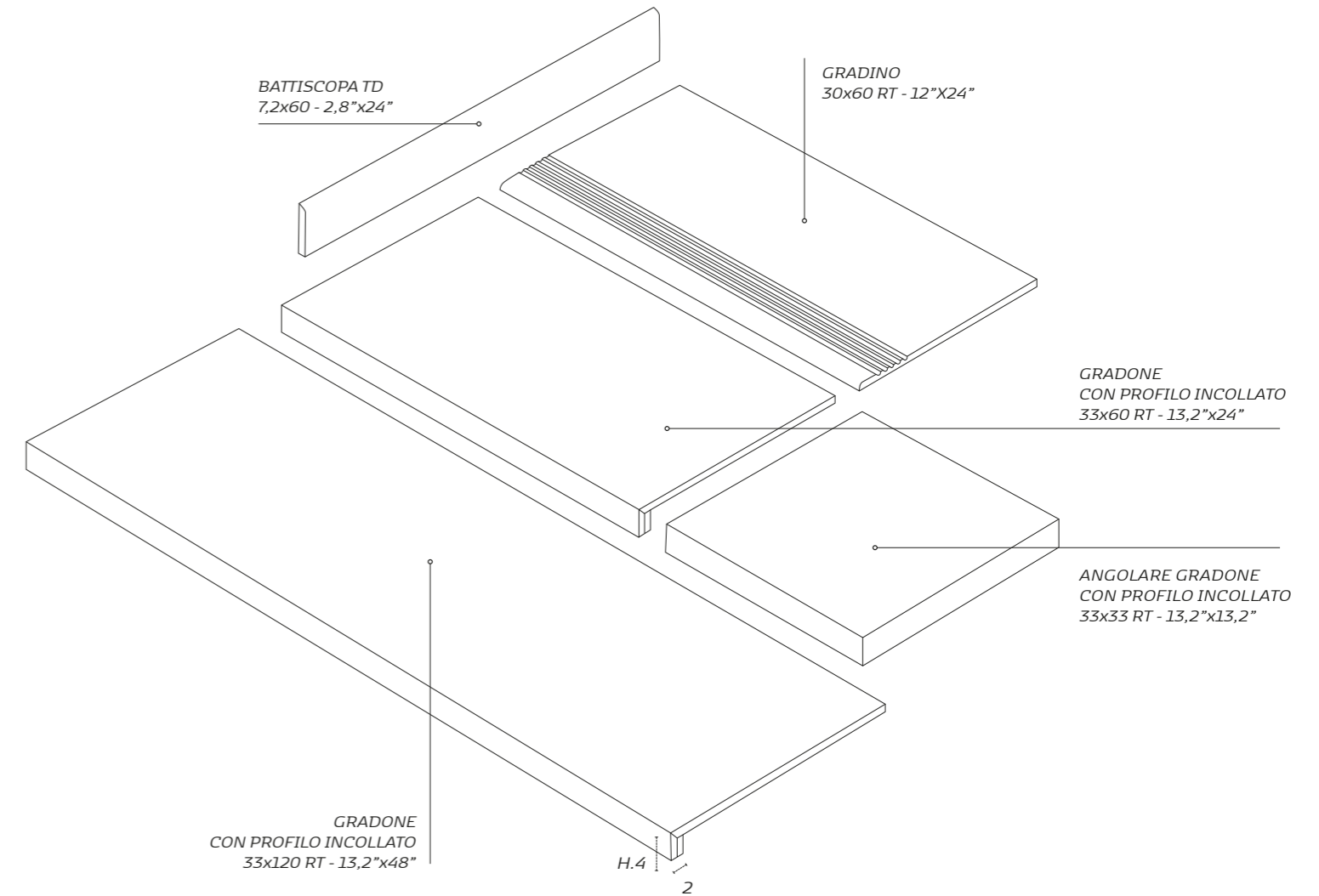

**AVVERTENZE PER LA POSA.**  
RECOMMENDATIONS FOR INSTALLATION.  
RECOMMANDATIONS POUR L'INSTALLATION.  
EMPFEHLUNGEN FÜR DIE INSTALLATION.

**Per la posa del materiale rettificato si prescrive una fuga minima di 2 mm.**  
As for rectified materials, a minimum joint of 2 mm is required.  
Pour la pose du matériau rectifié, il faut réaliser un joint minimum de 2 mm.  
Für die Verlegung des geschliffenen Materials ist eine Mindestfuge von 2 mm vorgeschrieben.

# Y M

## START TO CREATE YOUR MATCH

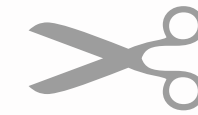

Progetta il tuo ambiente,  
dai forma al tuo stile.  
Taglia le tacche colore ai bordi  
delle pagine e componi in  
autonomia i tuoi abbinamenti tra  
pavimenti, rivestimenti e decori.

Design your setting, shape your style.  
Cut the coloured notches on the edges of the pages and  
put together your combinations of floor tiles, wall tiles and  
decorations independently.

Concevez votre espace, donnez vie à votre style.  
Découpez les encoches de couleur aux bords des pages et  
composez vos assortiments entre sols, revêtements muraux et  
décors en toute autonomie.

Gestalten Sie Ihr Umfeld, prägen Sie Ihren Stil.  
Schneiden Sie die Farbaussparungen an den Seitenrändern aus  
und stellen Sie Ihre eigenen Kombinationen von Böden, Wänden  
und Dekoren zusammen.

# YOUR MATCH WALL

Rivestimento in pasta bianca . White body wall tile  
Revêtements en pâte blanche . Weisscherbiger Wandfliesen

CERAMICHE  
SUPERGRES

## FRAME / SUN YOUR MATCH

Caldo e luminoso SUN combina decisione e vivacità. Energia tradotta in eleganza per contesti che si distinguono con gusto.

Warm and bright SUN combines decision with liveliness. Energy translated into elegance for settings that stand out tastefully.

Chaude et lumineuse, SUN associe décision et vivacité. Une énergie traduite en élégance pour des environnements qui se distinguent avec goût.

Warm und hell vereint SUN Entschlossenheit und Lebendigkeit. Energie übersetzt in Eleganz für geschmackvolle Räume.

Sun 50x120 RT . 20"x48" - Frame 50x120 RT . 20"x48"  
Profilo Metallo Glitter / Bordeaux 1x100 . 0.4"x40"





Sun 50x120 RT . 20"x48"  
Mural 50x120 RT . 20"x48"  
Mysterious White Lux 120x120 RT . 48"x48"  
Collection Purity Of Marble Tuscany



# TROPICAL / CHERRY

YOUR MATCH

Emotività e sensualità colorano spazi contraddistinti da vivaci contrasti cromatici. Ambienti contemporanei, espressione di libertà e leggerezza.

Emotions and sensuality colour in spaces marked by lively colour contrasts. Contemporary settings, expression of freedom and lightness.

Émotivité et sensualité colorent les espaces caractérisés par des contrastes de couleurs marqués. Espaces contemporains, expression de liberté et de légèreté.

Emotionalität und Sinnlichkeit prägen die Räume, die sich durch lebhaftige Farbkontraste auszeichnen. Zeitgenössische Umgebungen, ein Ausdruck von Freiheit und Leichtigkeit.

Cherry 50x120 RT . 20"x48"  
Tropical 50x120 RT . 20"x48"  
Collection Husk: Light 19,7x120 RT . 7 3/4"x48"





Tropical 50x120 RT . 20"x48"  
Collection Husk: Light 19,7x120 RT . 7 3/4"x48"

YM



Ice Sterutt Line 50x120 RT . 20"x48"  
Cherry 50x120 . 20"x48"  
Pearl 60x120 . 24"x48"

YM

# PAIN'T / ICE

YOUR MATCH

Lineare, neutro, versatile. ICE definisce gli spazi e le superfici con il suo stile moderno ed essenziale.

Linear, neutral, versatile. ICE defines spaces and surfaces with its modern and understated style.

Linéaire, neutre, polyvalent. ICE définit les espaces et les surfaces avec son style moderne et essentiel.

Geradlinig, neutral, vielseitig. ICE definiert Räume und Flächen mit seinem modernen und essentiellen Stil.

Ice 50x120 RT . 20"x48"  
Paint 50x120 RT . 20"x48"  
Mint 60x120 RT . 24"x48"



# FLOREAL / BAY

YOUR MATCH

Freschezza e toni dal verde al blu, conferiscono agli spazi un carattere armonico e astratto.

Freshness and shades of green and blue lend their surroundings a harmonious and abstract feel.

Fraîcheur et nuances du vert au bleu apportent aux espaces un caractère harmonieux et abstrait.

Frische und Töne von Grün bis Blau verleihen den Räumen einen harmonischen und abstrakten Charakter.

Bay 50x120 RT . 20"x48"  
Floral 50x120 RT . 20"x48"  
Collection Colovers: Love White 120x120 RT . 48"x48"



Bay 50x120 RT . 20"x48"  
Floral 50x120 RT . 20"x48"  
Collection Colovers: Love White 120x120 RT . 48"x48"





Bay 50x120 RT . 20"x48"  
Leaf 50x120 RT . 20"x48"  
Collection Natural Appeal: Natural Light 19,7x120 RT . 7 3/4"x48"

YM



# JUNGLE / LEAF

YOUR MATCH

Intimità e quiete filtrano attraverso un verde elegante.

Armonie tra concretezza e interiorità caratterizzano lo spazio con atmosfere raffinate.

Intimacy and quiet filter through an elegant shade of green. Harmonies amid concreteness and interior appeal characterise the space with refined atmospheres.

Intimité et calme filtrent à travers un vert élégant. Des harmonies entre aspect concret et intériorité caractérisent l'espace avec des atmosphères raffinées.

Intimität und Ruhe dringen durch elegantes Grün. Harmonien zwischen Konkretheit und Innerlichkeit prägen den Raum mit raffinierten Atmosphären.

Leaf 50x120 RT . 20"x48"  
Jungle 50x120 RT . 20"x48"  
Mosaico pad Green 30x30 RT . 12"x12"  
Tan 120x120 RT . 48"x48"



Leaf 50x120 RT . 20"x48"  
Jungle 50x120 RT . 20"x48"  
Mosaico pad Green 30x30 RT . 12"x12"  
Tan 120x120 RT . 48"x48"



# CREAM

YOUR MATCH

Un abbraccio morbido e accogliente che esprime la pienezza e il calore di qualsiasi ambiente.

A soft and welcoming embrace that expresses the fullness and the warmth of any setting.

Une étreinte douce et accueillante qui exprime la plénitude et la chaleur de n'importe quel espace.

Eine weiche, einladende Umarmung, die die Fülle und Wärme eines jeden Raumes zum Ausdruck bringt.

Cream 50x120 RT . 20"x48"  
Cream Struttura Line 50x120 RT . 20"x48"  
Mosaico Shade Warm 30x30 RT . 12"x12"  
Clay 120x120 RT . 48"x48"



## YOUR MATCH / WALL

Rivestimento in pasta bianca . White body wall tile  
Revêtements en pâte blanche . Weisscherbiger Wandfliesen

### BAY



50x120 RT . 20"x48"

### LEAF

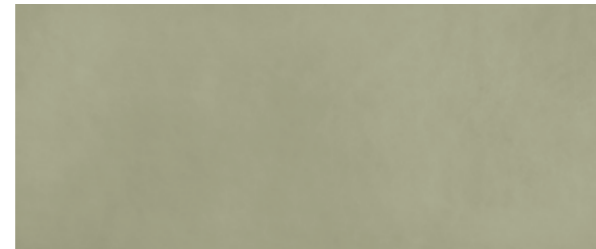

50x120 RT . 20"x48"

### ICE



50x120 RT . 20"x48"

### ICE STRUTTURA LINE



50x120 RT . 20"x48"

### SUN

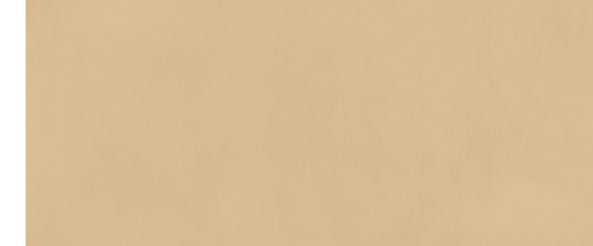

50x120 RT . 20"x48"

### CHERRY



50x120 RT . 20"x48"

### CREAM



50x120 RT . 20"x48"

### CREAM STRUTTURA LINE

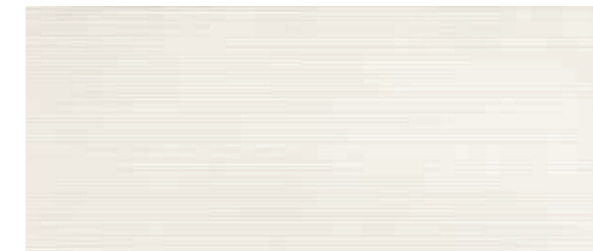

50x120 RT . 20"x48"

YOUR MATCH  
WALL  
SUN

YOUR MATCH  
WALL  
SUN

YOUR MATCH  
WALL  
CHERRY

YOUR MATCH  
WALL  
CHERRY

YOUR MATCH  
WALL  
CREAM

YOUR MATCH  
WALL  
CREAM  
STRUTTURA LINE

YOUR MATCH  
WALL  
SUN

YOUR MATCH  
WALL  
SUN

YOUR MATCH  
WALL  
CHERRY

YOUR MATCH  
WALL  
CHERRY

YOUR MATCH  
WALL  
CREAM

YOUR MATCH  
WALL  
CREAM  
STRUTTURA LINE



70



71

## YOUR MATCH / WALL

Rivestimento in pasta bianca . White body wall tile  
 Revêtements en pâte blanche . Weisscherbiger Wandfliesen

### TROPICAL



50x120 RT . 20"x48"

### FLORAL



50x120 RT . 20"x48"

### JUNGLE



50x120 RT . 20"x48"

Mosaico in Gres Porcellanato . Porcelain Tiles Mosaic

#### PAD 30x30 RT . 12"x12"

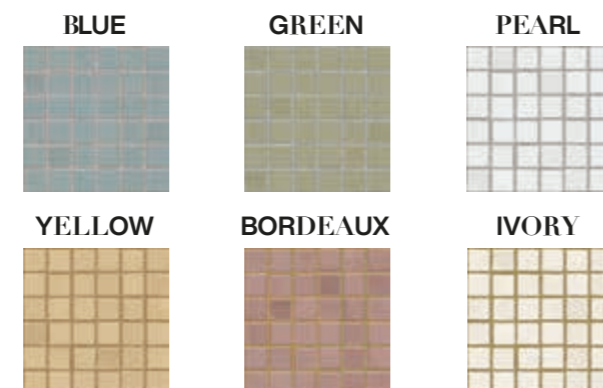

### MURAL



50x120 RT . 20"x48"

### PAINT



50x120 RT . 20"x48"

### FRAME



50x120 RT . 20"x48"

Mosaico in Gres Porcellanato . Porcelain Tiles Mosaic

#### SHADE 30x30 RT . 12"x12"

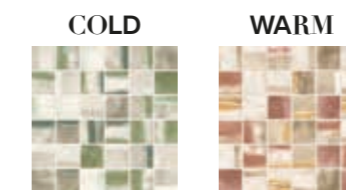

- PROFILO METALLO / GLITTER BLUE**
  - PROFILO METALLO / GLITTER GREEN**
  - PROFILO METALLO / GLITTER BORDEAUX**
  - PROFILO METALLO / GLITTER YELLOW**
- 1x100 RT . 0.4"x40"



# Un ambiente per tante atmosfere

One setting for multiple atmospheres.  
Un environnement pour de nombreuses atmosphères.  
Eine Umgebung, viele Atmosphären.

## FRAME



FRAME 50x120 RT  
SUN 50x120 RT



FRAME 50x120 RT  
CHERRY 50x120 RT



FRAME 50x120 RT  
CREAM 50x120 RT

## MURAL



MURAL 50x120 RT  
SUN 50x120 RT



MURAL 50x120 RT  
CHERRY 50x120 RT



MURAL 50x120 RT  
BAY 50x120 RT

## TROPICAL



TROPICAL 50x120 RT  
CHERRY 50x120 RT



TROPICAL 50x120 RT  
SUN 50x120 RT



TROPICAL 50x120 RT  
LEAF 50x120 RT

## JUNGLE



JUNGLE 50x120 RT  
LEAF 50x120 RT



JUNGLE 50x120 RT  
CREAM 50x120 RT



JUNGLE 50x120 RT  
SUN 50x120 RT

## PAINT

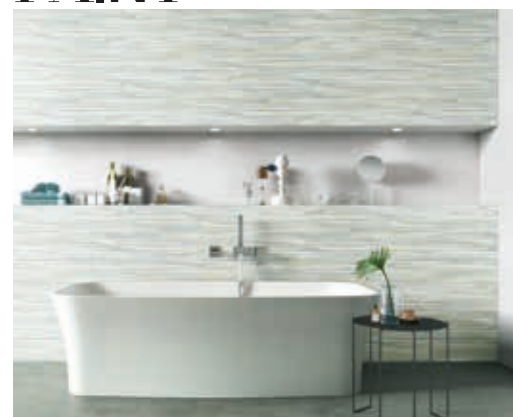

PAINT 50x120 RT  
ICE 50x120 RT



PAINT 50x120 RT  
LEAF 50x120 RT



PAINT 50x120 RT  
BAY 50x120 RT

## FLORAL



FLORAL 50x120 RT  
BAY 50x120 RT



FLORAL 50x120 RT  
ICE 50x120 RT



FLORAL 50x120 RT  
CHERRY 50x120 RT



LEAF 50x120 RT  
BAY 50x120 RT



SUN 50x120 RT  
CHERRY 50x120 RT



SUN 50x120 RT  
LEAF 50x120 RT



ICE STRUTTURA 50x120 RT  
CHERRY 50x120 RT



CREAM STRUTTURA 50x120 RT  
SUN 50x120 RT



ICE STRUTTURA 50x120 RT  
LEAF 50x120 RT

Mosaico Shade

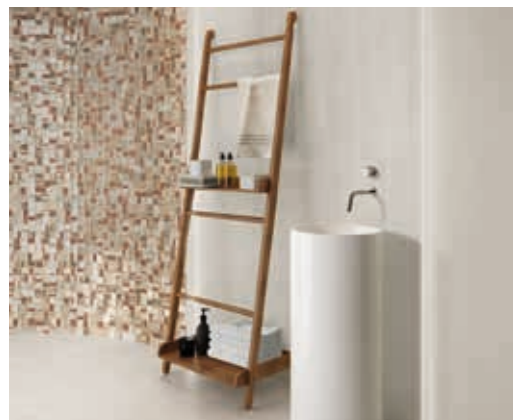

MOSAICO SHADE WARM 30x30  
CREAM 50x120 RT

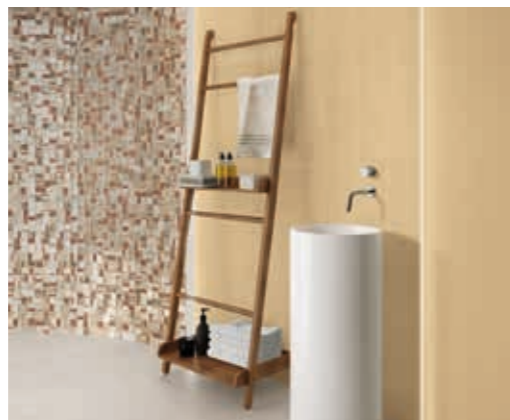

MOSAICO SHADE WARM 30x30  
SUN 50x120 RT



MOSAICO SHADE COLD 30x30  
LEAF 50x120 RT



Mosaico Shade Cold 30x30 RT . 12"x12"

# LA CERAMICA. UNA SCELTA SICURA.

Ceramics. A safe choice / La céramique. Un choix sûr / Keramik. Eine sichere Wahl.



**IGIENICA**

La ceramica è facile da pulire, igienica e pratica; basta un semplice detergente neutro per rimuovere lo sporco e facilmente ritorna alla sua bellezza originaria.

## HYGIENIC

Ceramic material is easy to clean, hygienic and practical; all it takes is a simple, neutral detergent to remove dirt and restore it to its original splendour.

## HYGIÉNIQUE

La céramique est facile à nettoyer, hygiénique et pratique. Il suffit d'un simple détergent neutre pour éliminer la saleté et la céramique retrouve sa beauté initiale.

## HYGIENISCH

Keramik ist pflegeleicht, hygienisch und praktisch; ein einfacher Neutralreiniger genügt, um Schmutz zu entfernen und die Keramik erhält ihre ursprüngliche Schönheit zurück.



**SALUBRE**

Grazie alle sue caratteristiche fisiche la ceramica non rilascia alcuna sostanza nociva o VOC (sostanze organiche volatili) nell'ambiente in cui viviamo. Allo stesso modo non emette odori.

## HEALTHY

Thanks to its physical characteristics, ceramic material does not release any harmful substances or VOC (volatile organic substances) into the environment we live in, nor does it give off odours.

## SALUBRE

Grâce à ses caractéristiques physiques, la céramique ne libère aucune substance nocive ou COV (composés organiques volatils) dans l'environnement dans lequel nous vivons. Elle n'émet pas d'odeurs non plus.

## NICHT GESUNDHEITSSCHÄDIGEND

Aufgrund ihrer physikalischen Eigenschaften setzt die Keramik keine Schadstoffe oder VOCs (flüchtigen Kohlenwasserstoffe) in die Umwelt frei. Sie gibt auch keine Gerüche ab.



**RESISTENTE**

Il gres porcellanato è un materiale tecnico ultra compatto, altamente resistente all'usura; sopporta bene calpestio, urti, graffi e carichi pesanti.

## WEAR RESISTANT

Porcelain stoneware is an ultra-compact technical material, extremely resistant to wear, tread, shock, scratching and heavy loads.

## RÉSISTANT À L'USURE

Le grès cérame est un matériau technique ultra compact, extrêmement résistant à l'usure. Il supporte bien le piétinement, les chocs, les rayures et les charges lourdes.

## VERSCHLEISSFEST

Feinsteinzeug ist ein ultrakompaktes technisches Material, das sehr widerstandsfähig gegen Verschleiß und Trittbelastung ist und dem Stöße, Kratzer und schwere Lasten nichts ausmachen.



**ANTIMACCHIA**

La ceramica non teme macchie e non viene danneggiata con l'utilizzo di solventi e detergenti.

## STAIN RESISTANT

Ceramic material is resistant to stains and is not damaged by the use of solvents and detergents.

## ANTI-TACHES

La céramique ne craint pas les taches et l'utilisation de solvants et de détergents ne l'abîme pas.

## FLECKABWEISEND

Keramik ist unempfindlich gegen Flecken und wird durch Lösungs- und Reinigungsmittel nicht angegriffen.



**INGELIVA**

Il gres porcellanato resiste al gelo e a tutti gli attacchi degli agenti atmosferici, ed è quindi il prodotto ideale anche in ambienti esterni.

## FROSTPROOF

Porcelain stoneware is resistant to frost and to all kinds of attack from the elements, making it the ideal product also for outdoors.

## INGÉLIF

Le grès cérame résiste au gel et à toutes les attaques des agents atmosphériques. Il est, par conséquent, le produit idéal dans des environnements extérieurs aussi.

## FROSTBESTÄNDIG

Feinsteinzeug ist frost- und witterungsbeständig und somit das ideale Produkt für die Verwendung in Außenbereichen.



**VERSATILE**

La ceramica consente tante variazioni di stile e design, grazie all'ampia disponibilità di formati, spessori, finiture e tinte. Inoltre può essere utilizzata in qualsiasi ambiente, sia a pavimento che a rivestimento, in interno o esterno, in ambienti residenziali o pubblici.

## VERSATILE

All sorts of style and design variants are possible with ceramics, thanks to the wide availability of different sizes, thicknesses, finishes and colours. It can also be used anywhere, on both floors and walls, indoors or outdoors, in residential or public settings.

## VERSATILE

La céramique permet de très nombreuses variations de style et de design grâce à la vaste disponibilité de formats, d'épaisseurs, de finitions et de teintes. En outre, elle peut être utilisée dans tous les environnements, aussi bien au sol qu'au mur, à l'intérieur ou à l'extérieur, dans des contextes résidentiels ou publics.

## VIELSEITIG

Keramik ermöglicht dank der Verfügbarkeit von vielen Formaten, Stärken, Oberflächen und Farben viele Variationen in Stil und Design. Es kann auch in jeder Umgebung eingesetzt werden, ob auf dem Boden oder an der Wand, im Innen- oder Außenbereich, im Wohnbereich oder in öffentlichen Bereichen.



## PRODOTTO NEL RISPETTO DELL'AMBIENTE

Produced with respect for the environment  
Produite dans le respect de l'environnement  
Umweltfreundliches Produkt



## RESISTENTE AI RAGGI UV: COLORI STABILI NEL TEMPO

Resistant to UV rays for lasting colour stability  
Résistante aux rayons UV : des couleurs stables dans le temps  
UV-beständig: dauerhafte Farbstabilität



## PRODOTTO IGNIFUGO

Fireproof  
Produit ignifuge  
Feuerfest

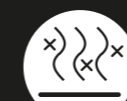

## NON ASSORBE ODORI

Does not absorb odours  
N'absorbe pas les odeurs  
Absorbiert keine Gerüche



## IDEALE PER IL RISCALDAMENTO A PAVIMENTO

Ideal for underfloor heating  
Idéale pour le chauffage au sol  
Ideal für die Fußbodenheizung

Per maggiori informazioni consultare il sito  
[www.ceramica.info](http://www.ceramica.info) e [www.supergres.com](http://www.supergres.com)

To find out more, consult the website  
[www.ceramica.info](http://www.ceramica.info) and [www.supergres.com](http://www.supergres.com)

Pour plus d'informations, consulter le site  
[www.ceramica.info](http://www.ceramica.info) et [www.supergres.com](http://www.supergres.com)

Für weitere Informationen besuchen Sie bitte  
die Websites  
[www.ceramica.info](http://www.ceramica.info) und [www.supergres.com](http://www.supergres.com)



## Gres Porcellanato / Porcelain stoneware Grès cérame / Feinsteinzeug

Norma di riferimento: EN 14441 (ISO 13006) Allegato G - Piastrelle di ceramica pressate a secco con basso assorbimento d'acqua (E ≤ 0,5%)  
Reference standard: EN 14441 (ISO 13006) Appendix G - Dry pressed ceramic tiles with low water absorption (Ev ≤ 0,5%) .



CERAMICHE  
**SUPERGRES**  
MADE in ITALY

CERAMICHE  
**SUPERGRES**  
MADE in ITALY

### GRUPPO B la UGL

| CARATTERISTICHE TECNICHE<br>Technical characteristics . Caracteristiques techniques<br>Technische eigenschaften   | NORMA<br>Norms . Normes<br>Normen | REQUISITI RICHIESTI<br>Requirements . Conditions requisés<br>Geforderte eigenschaften |   |         | VALORE MEDIO SUPERGRES *<br>Average rating . Valeur moyenne<br>Durchschnittswert |   |
|---|-----------------------------------|---|---|---------|--|---|
|   |                                   | 7 cm ≤ N < 15 cm  | N ≥ 15 cm   |         |  |   |
| <b>Lunghezza e larghezza dei lati</b> . Lenght and width of the sides<br>Longuer et largeur de côtés . Länge und Breite   | ISO 10545-2                       | RETTIFICATI   | ± 0,4 mm  | ± 0,3 % | ± 1,0 mm   | <b>Conforme</b> . According to<br>Conforme . Gemäss |
| <b>Rettilineità degli spigoli</b> . Straightness<br>Equerrage des angles . Kantengeradheit  |                                   |   | ± 0,4 mm  | ± 0,3 % | ± 0,8 mm   | <b>Conforme</b> . According to<br>Conforme . Gemäss |
| <b>Ortogonalità**</b> . Rectangularity**<br>Orthogonalité . Rechtwinkligkeit  |                                   |   | ± 0,4 mm  | ± 0,3 % | ± 1,5 mm   | <b>Conforme</b> . According to<br>Conforme . Gemäss |
| <b>Planarità</b> . Flatness<br>Planéité . Planität  |                                   |   | ± 0,6 mm  | ± 0,4 % | ± 1,8 mm   | <b>Conforme</b> . According to<br>Conforme . Gemäss |
| <b>Spessore</b> . Thickness<br>Epaisseur . Stärke   | ISO 10545-2                       |   | ± 0,5 mm  | ± 5 %   | ± 0,5 mm   | <b>Conforme</b> . According to<br>Conforme . Gemäss |
| <b>Assorbimento % d'acqua</b> . Water absorption<br>Absorption d'eau . Wasseraufnahme   | ISO 10545-3                       |   | Ev ≤ 0,5%   |         | <b>Conforme</b> . According to<br>Conforme . Gemäss                              |   |
| <b>Determinazione della resistenza a flessione e della forza di rottura</b><br>Flexion and break resistance<br>Résistance à la flexion et à la force de rupture<br>Biegefestigkeit und Bruchlast  | ISO 10545-4                       |   | <b>Spessore</b><br>Thickness<br>Epaisseur<br>Stärke<br>≥ 7,5 mm $\left[ \begin{array}{l} S \geq 1300 \\ R \geq 35 \text{ N/mm}^2 \end{array} \right.$ |         | <b>Conforme</b> . According to<br>Conforme . Gemäss                              |   |
| <b>Determinazione della resistenza all'abrasione profonda (porcellanato non smaltato) UGL</b><br>Deep Scratch Resistance (unglazed porcelain) UGL<br>Résistance à l'abrasion profonde (grès cérame) UGL<br>Tiefenverschleissbeständigkeit (unglasierte Feinsteinzeug) UGL   | ISO 10545-6                       |   | ≤ 175 mm <sup>3</sup>   |         | <b>Conforme</b> . According to<br>Conforme . Gemäss                              |   |
| <b>Coefficiente di espansione termica lineare tra 20° e 100° C</b><br>Linear thermal expansion 20°C to 100°C<br>Dilatation thermique linéaire entre 20°C et 100°C<br>Lineare Waerme-ausdehnung zwischen 20°C und 100°C  | ISO 10545-8                       |   | <b>Metodo di prova disponibile</b> . Test method available<br>Méthode d'essai disponible . Prüfverfahren verfügbar                                    |         | <b>Conforme</b> . According to<br>Conforme . Gemäss                              |   |
| <b>Resistenza agli sbalzi termici</b> . Thermal shock resistance<br>Résistance aux écarts de Température . Temperaturwechselbeständigkeit   | ISO 10545-9                       |   | <b>Metodo di prova disponibile</b> . Test method available<br>Méthode d'essai disponible . Prüfverfahren verfügbar                                    |         | <b>Conforme</b> . According to<br>Conforme . Gemäss                              |   |
| <b>Resistenza al gelo</b> . Frost resistance<br>Résistance au gel . Frostbeständigkeit  | ISO 10545-12                      |   | <b>Metodo di prova disponibile</b> . Test method available<br>Méthode d'essai disponible . Prüfverfahren verfügbar                                    |         | <b>Conforme</b> . According to<br>Conforme . Gemäss                              |   |
| <b>Determinazione della resistenza chimica</b> . Chemical resistance<br>Résistance chimique . Chemikalienbeständigkeit  | ISO 10545-13                      |   | <b>Classe UB minimo (UGL)</b> . Class UB min (UGL)<br>Clase UB min (UGL) . Catégorie UB min (UGL)   |         | UA<br>ULA<br>UHA   |   |
| <b>Reazione al fuoco</b> . Reaction to fire<br>Réaction au feu . Brandverhalten   | -                                 |   | <b>Classe A1 o A1 fl</b> . Class A1 o A1 fl<br>Clase A1 ou A1 fl . Klasse A1 oder A1 fl   |         | <b>Conforme</b> . According to<br>Conforme . Gemäss                              |   |
| <b>Determinazione della resistenza alle macchie</b> . Resistance to staining<br>Résistance aux taches . Beständigkeit gegen Fleckenbil  | ISO 10545-14                      |   | <b>Classe 3 minimo</b> . Class 3 min<br>Clase 3 min . Klasse 3 min  |         | <b>Conforme</b> . According to<br>Conforme . Gemäss                              |   |
| <b>Resistenza allo scivolamento</b> . Slip resistance<br>Résistance au glissement . Bestimmung der Rutschemmungsfähigkeit   | DIN 51130                         |   | <b>Classificazione R</b> . Classification R<br>Evaluación R R . Klassifizierung R   |         | <b>R9</b>  |   |
| <b>Resistenza allo scivolamento - coefficiente di attrito dinamico (DCOF)</b><br>Slip resistance - dynamic friction coefficient<br>Résistance au glissement - résistance de frottement dynamique<br>Bestimmung der Rutschemmungsfähigkeit - dynamischer reibungskoeffizient | ANSI A326.3:2017                  |   | ≥ 0,42 wet  |         | <b>Conforme</b> . According to<br>Conforme . Gemäss                              |   |
| <b>Coefficiente di attrito dinamico</b> . Dynamic friction coefficient<br>Résistance de frottement dynamique . Dynamischer reibungskoeffizient  | METODO<br>B.C.R.A.                |   | D.M.I. Giugno 1989 n.236 (μ > 0,40)   |         | <b>Conforme</b> . According to<br>Conforme . Gemäss                              |   |

GRADO DI VARIAZIONE CROMATICA. Ogni prodotto si caratterizza per un grado di stonizzazione variabile da prodotto a prodotto, da colore a colore. Per stonizzazione s'intende variazione di gradazione cromatica da piastrella a piastrella.  
COLOUR SHADE VARIATION. Every product is characterised by colour-shading that can vary from one product to another and from one colour to another. When referring to colour-shading we refer to the chromatic variation of the tile surface.



Prodotto con marcata variazione cromatica  
Product with a marked chromatic variation

## Rivestimento in pasta bianca / White body wall tiles Revêtements en pâte blanche / Weisscherbiger Wandfliesen

EN 14411 Allegato L Piastrelle di ceramica pressate a secco (E > 10 %) - Gruppo BIII GL (smaltate, glazed)  
EN 14411 (ISO 13006) Appendix L Dry pressed ceramic tiles (Ev > 10 %)



CERAMICHE  
**SUPERGRES**  
MADE in ITALY

CERAMICHE  
**SUPERGRES**  
MADE in ITALY

### GRUPPO B III GL

| CARATTERISTICHE TECNICHE<br>Technical characteristics . Caracteristiques techniques<br>Technische eigenschaften  | NORMA<br>Norms . Normes<br>Normen | REQUISITI RICHIESTI<br>Requirements . Conditions requisés<br>Geforderte eigenschaften |  |         | VALORE MEDIO SUPERGRES *<br>Average rating . Valeur moyenne<br>Durchschnittswert |   |
|--|-----------------------------------|---|--|---------|--|---|
|  |                                   | 7 cm ≤ N < 15 cm  | N ≥ 15 cm  |         |  |   |
| <b>Lunghezza e larghezza dei lati</b> . Lenght and width of the sides<br>Longuer et largeur de côtés . Länge und Breite  | ISO 10545-2                       | RETTIFICATI   | ± 0,4 mm   | ± 0,3 % | ± 1,0 mm   | <b>Conforme</b> . According to<br>Conforme . Gemäss |
| <b>Rettilineità degli spigoli</b> . Straightness<br>Equerrage des angles . Kantengeradheit   |                                   |   | ± 0,4 mm   | ± 0,3 % | ± 0,8 mm   | <b>Conforme</b> . According to<br>Conforme . Gemäss |
| <b>Ortogonalità**</b> . Rectangularity**<br>Orthogonalité . Rechtwinkligkeit   |                                   |   | ± 0,4 mm   | ± 0,3 % | ± 1,5 mm   | <b>Conforme</b> . According to<br>Conforme . Gemäss |
| <b>Planarità</b> . Flatness<br>Planéité . Planität   |                                   |   | ± 0,6 mm   | ± 0,4 % | ± 1,8 mm   | <b>Conforme</b> . According to<br>Conforme . Gemäss |
| <b>Spessore</b> . Thickness<br>Epaisseur . Stärke  | ISO 10545-2                       |   | ± 0,5 mm   | ± 10 %  | ± 0,5 mm   | <b>Conforme</b> . According to<br>Conforme . Gemäss |
| <b>Assorbimento % d'acqua</b> . Water absorption<br>Absorption d'eau . Wasseraufnahme  | ISO 10545-3                       |   | Ev > 10%   |         | <b>Conforme</b> . According to<br>Conforme . Gemäss                              |   |
| <b>Determinazione della resistenza a flessione e della forza di rottura</b><br>Flexion and break resistance<br>Résistance à la flexion et à la force de rupture<br>Biegefestigkeit und Bruchlast | ISO 10545-4                       |   | <b>Spessore</b><br>Thickness<br>Epaisseur<br>Stärke<br>≥ 7,5 mm $\left[ \begin{array}{l} S \geq 600 \text{ N} \\ R \geq 15 \text{ N/mm}^2 \end{array} \right.$ |         | <b>Conforme</b> . According to<br>Conforme . Gemäss                              |   |
| <b>Determinazione della resistenza al cavillo</b><br>Crazing resistance<br>Résistance aux craquelures<br>Haarriß-Beständigkeit   | ISO 10545-11                      |   | <b>Richiesta</b> . Required<br>Requise . Entforderlich   |         | <b>Conforme</b> . According to<br>Conforme . Gemäss                              |   |
| <b>Determinazione della resistenza chimica</b> . Chemical resistance<br>Résistance chimique . Chemikalienbeständigkeit   | ISO 10545-13                      |   | <b>GB minimo (GL)</b> . GB min (GL)<br>GB min (GL) . GB min (GL)   |         | <b>Conforme</b> . According to<br>Conforme . Gemäss                              |   |
| <b>Determinazione della resistenza alle macchie</b> . Resistance to staining<br>Résistance aux taches . Beständigkeit gegen Fleckenbil   | ISO 10545-14                      |   | <b>Classe 3 minimo</b> . Class 3 min<br>Clase 3 min . Klasse 3 min   |         | <b>Conforme</b> . According to<br>Conforme . Gemäss                              |   |
| <b>Reazione al fuoco</b> . Reaction to fire<br>Réaction au feu . Brandverhalten  | -                                 |   | <b>Classe A1 o A1 fl</b> . Class A1 o A1 fl<br>Clase A1 ou A1 fl . Klasse A1 oder A1 fl  |         | <b>Conforme</b> . According to<br>Conforme . Gemäss                              |   |

\* Valori riferiti ai fondi. Le caratteristiche tecniche fanno riferimento al formato nominale delle piastrelle espresso in mm.  
These values refer to the bottoms. The technical characteristics refer to the nominal size of tiles expressed in mm.  
Valeurs se référant aux fonds. Les caractéristiques techniques se réfèrent au format nominal des carreaux exprimé en mm.  
Werte bezogen auf Grundfliesen. Die Angaben beziehen sich auf die Nenngröße der Fliesen in mm.

Se non indicato diversamente, i valori delle prove tecniche si riferiscono alla superficie naturale.  
Unless otherwise indicated, the values of technical tests refer to the natural surface finish.  
Sauf indication contraire, les valeurs des tests techniques se rapportent à la surface naturelle.  
Wenn nicht anders angegeben beziehen sich die Werte der technischen Tests auf die natürliche Oberfläche.

\*\* Per piastrelle rettangolari che abbiano il lato maggiore L ≥ 60 cm, e rapporto tra i lati ≥ 3, la misurazione dell'ortogonalità deve venire condotta solo sul lato corto.  
For rectangular tiles with longest side L ≥ 60 cm and a ratio length/width L/W ≥ 3, the measurement of orthogonality should only be carried out on short edges.  
Pour les carreaux rectangulaires qui ont le côté le plus long L ≥ 60 cm, et le rapport entre les côtés ≥ 3, la mesure de l'orthogonalité se fait seulement sur le côté le plus court.  
Bei rechteckigen Fliesen, mit der längsten Seite L ≥ 60 cm und einem Seitenverhältnis von ≥ 3 darf die Messung der Rechteckigkeit nur an der kurzen Seite durchgeführt werden.

# IMBALLI

Packing / Emballage / Verpackung

## Gres Porcellanato . Porcelain stoneware . Grès cérame . Feinsteinzeug

|   | spessore    | pz/box | mq/sc   | kg/sc | sc/plt | mq/plt | kg/plt |
|---|-------------|--------|---------|-------|--------|--------|--------|
| 120x120 RT                                  | <b>9 mm</b> | 2      | 2,88    | 60,00 | 20     | 57,60  | 1212   |
| 60x120 RT                                   | <b>9 mm</b> | 2      | 1,44    | 30,00 | 35     | 50,40  | 1062   |
| 60x60 RT                                    | <b>9 mm</b> | 3      | 1,08    | 22,00 | 40     | 43,20  | 892    |
| 30x60 RT                                    | <b>9 mm</b> | 7      | 1,26    | 25,00 | 40     | 50,40  | 1012   |
| Mosaico su rete 30x30 RT                    | <b>9 mm</b> | 10     | 0,90    | 16,00 | 30     | 27,00  | 495    |
| Gradone c/profilo incollato 33x120 RT       | -           | 2      | -       | -     | -      | -      | -      |
| Gradone c/profilo incollato 33x60 RT        | -           | 4      | -       | -     | -      | -      | -      |
| Angolo Gradone c/profilo incollato 33x33 RT | -           | 4      | -       | -     | -      | -      | -      |
| Gradino 30x60                               | -           | 7      | -       | -     | -      | -      | -      |
| Battiscopa total dek 7,2x60                 | -           | 10     | 6,00 ml | 9,40  | 70     | 420 ml | 673    |

## Rivestimento in pasta bianca . White body wall tile . Revêtements en pâte blanche . Weisscherbiger Wandfliesen

|                               | spessore       | pz/box | mq/sc | kg/sc | sc/plt | mq/plt | kg/plt |
|-------------------------------|----------------|--------|-------|-------|--------|--------|--------|
| 50x120 RT                     | <b>8,5 mm</b>  | 3      | 1,80  | 30,00 | 35     | 63,00  | 1065   |
| Struttura 50X120 RT           | <b>8,5 mm*</b> | 3      | 1,80  | 39,00 | 30     | 54,00  | 1162   |
| Mosaico Pad 30x30 RT          | <b>9 mm</b>    | 6      | 0,54  | 9,00  | 48     | 25,92  | 447    |
| Mosaico Shade 30x30 RT        | <b>9 mm</b>    | 6      | 0,54  | 9,00  | 48     | 25,92  | 447    |
| Profilo Metallo/Glitter 1x100 | <b>8 mm</b>    | 3      | -     | -     | -      | -      | -      |

\* spessore riferito al fondo liscio equivalente

© Copyright 2021 Ceramiche Supergres Casalgrande (Reggio Emilia) - Italy  
Pubblicato da Ceramiche Supergres. Strada Statale 467, n° 34 - 42013 Casalgrande (RE) Italy  
Settembre 2021

Progetto, direzione e coordinamento a cura dell'ufficio marketing Ceramiche Supergres

© Copyright 2021 by Ceramiche Supergres Casalgrande (Reggio Emilia) - Italy  
Published by Ceramiche Supergres. Strada Statale 467, n° 34 - 42013 Casalgrande (RE) Italy  
September 2021

Project, management and co-ordination by marketing Ceramiche Supergres

Finito di stampare a Modena (MO) nel mese di settembre 2021 per conto di Ceramiche Supergres - Strada Statale 467, n° 34 - 42013 Casalgrande (RE) Italy.  
Printed in Modena (MO) in the month of September 2021 on behalf of Ceramiche Supergres - Strada Statale 467, n° 34 - 42013 Casalgrande (RE) Italy.

I prodotti, i marchi e le immagini riprodotte nel presente catalogo sono tutelati ai sensi della normativa vigente in materia di proprietà intellettuale.  
Ogni violazione degli stessi verrà perseguita a norma di legge.

All products, trade-marks and photographs reproduced in this catalogue are subject to all existing intellectual property laws.  
Any breach thereof will be dealt with under the provisions provided by such law.

CERAMICHE  
**SUPERGRES**

Office: Strada Statale 467, 34  
42013 Casalgrande (RE) Italy  
Ph. +39 0522 997411  
Fax Export +39 0522 997415  
Fax Italia +39 0522 997494

Warehouse  
Via dell'industria, 1 Villaggio Macina  
42013 Salvaterra di Casalgrande (RE) Italy

[info@supergres.com](mailto:info@supergres.com)  
[www.supergres.com](http://www.supergres.com)